



**Care and Service
of
Passenger and Light Truck Tires**

CHAPTER 1 - BASIC TIRE INFORMATION

Overview1
 Tire Construction and Terminology1
 Tire Size Designations2
 The Sidewall Story5
 Tire Service Description9
 Uniform Tire Quality Grading Standards for Passenger Car Tires 10
 Sidewall Marking for Retread Tires 10
 Tire Registration and Recall Information 10

CHAPTER 2 - TIRE CARE AND SERVICE

Overview 11
 Proper Tire Inflation 11
 Tire Loading 14
 Sudden Ride Disturbance or Vibration 14
 Tire Inspection Guidelines 14
 Tire Service Life 16
 Tire Rotation 19
 Conditions Affecting Tread Wear 19
 Proper Tire Repair 21
 Passenger and Light Truck Used Tires 23
 Spare Tire Maintenance 24
 Tire Storage Recommendations 24
 Cleaning Tires 24
 Tire Sidewall Indentations 24
 Tire Explosions and Flammable Substances 25
 Tire Spinning 26
 Mounting and Demounting Procedures 26
 Tire/Wheel Balancing and Installation 29
 Ride Comfort Optimization Procedures and Diagnostics..... 30
 “Zipper Ruptures” in Steel Cord Radial Medium and Light Truck Tires 30
 Tire Retreading 31

CHAPTER 3 - TIRE REPLACEMENT GUIDELINES

Overview32

The Right Tire for the Vehicle32

Tire Size, Inflation & Load32

Self-Supporting Runflat Tire Replacement.....34

Tire Mixing35

Replacing Less Than Four Tires.....36

Tire Rim/Wheel Selection.....37

Tire, Vehicle Clearance and Tire Diameter.....37

Plus Sizing37

Important Considerations39

Passenger and Light Truck Used Tires40

CHAPTER 4 - RECREATIONAL VEHICLE APPLICATIONS

Overview 41

RV Tire and Vehicle Placards/Labels 41

RV Tire and Vehicle Load Limits 42

Proper RV Tire Inflation..... 42

Proper RV Tire and Vehicle Loading..... 44

How to Determine an RV’s Actual Weight 45

RV Tire Inspection Guidelines 46

Severe Service Operation..... 46

Sudden Ride Disturbance/Vibration 47

Tire Rotation..... 47

RV Tire Service Life..... 47

Weighing an RV or Travel Trailer 48

Weighing a Single Axle Recreational Vehicle 48

Weighing a Tandem Axle Recreational Vehicle 49

Weighing a Pulling Vehicle and Travel Trailer..... 49

Proper Tire Repair..... 51

Parking an RV 52

Passenger and Light Truck Used Tires 53

Storing RV Tires..... 53

Purpose

The purpose of this manual is to provide both the tire service professional and end user (consumer) with an understanding of the many factors that are essential to the proper care and service of passenger and light truck tires (also known as "light vehicle tires"*).

This manual is not all inclusive. The U.S. Tire Manufacturers Association (USTMA) does not intend for it to eliminate the need for in-depth, hands-on training, especially in such areas as: tire mounting and demounting; tire and wheel balancing; tire retreading; tire pressure monitoring systems (TPMS) and tire repairing.

Personnel that service tires must receive professional training. Tire manufacturers and industry organizations, such as the Tire Industry Association**, provide comprehensive, hands-on training programs for tire service professionals.

The "WARNINGS" contained in USTMA publications are important and must be followed. Questions pertaining to specific products or pieces of service equipment should be addressed directly to the manufacturer of that product.

USTMA does not endorse, certify, approve, consent, or confirm in any way products, brands, creations/inventions, etc. of any company, corporation, business or firm.

Introduction

The USTMA represents companies that manufacture tires in the United States. The USTMA and its members recognize how important tires are to safety.

Tires are designed and manufactured with advanced technology and great care to provide thousands of miles of excellent service. For maximum safety, performance and service life, they must be maintained properly.

This Care and Service Manual will address these and other factors relative to the care and service of passenger car and light truck tires. For the most current printed materials, visit the USTMA web site at www.USTires.org and click on "Publications" to search for other manuals, bulletins, wall charts, etc. For questions regarding USTMA publications, call 202-682-4800.

THE MOST IMPORTANT FACTORS IN TIRE SAFETY, PERFORMANCE AND SERVICE LIFE ARE:

- PROPER TIRE SIZE, TYPE, AND LOAD CAPACITY (OR LOAD RANGE)
- PROPER INFLATION PRESSURE
- PROPER VEHICLE LOADING
- REGULAR TIRE ROTATION
- REGULAR INSPECTION
- PROPER TIRE REPAIR
- VEHICLE CONDITION, ALIGNMENT AND MAINTENANCE
- GOOD DRIVING HABITS

Care and Service of Passenger and Light Truck Tires

CHAPTERS:

1. Basic Tire Information
2. Tire Care and Service
3. Tire Replacement Guidelines
4. Recreational Vehicle Applications

Published by:

U.S. Tire Manufacturers Association
1400 K Street, NW Suite 900
Washington, DC 20005
www.USTires.org

Duplication and distribution of this work in the original form is permitted. All other rights reserved.

Copyright © 2017 U.S. Tire Manufacturers Association

* The Federal Motor Vehicle Safety Standard 571.139 defines "light vehicles" as motor vehicles with a Gross Vehicle Weight Rating (GVWR) of 10,000 lbs. or less. Tire sizes for light vehicles include all passenger car tires and light truck tires through load range "E."

** The Tire Industry Association (TIA) is a trade association that represents all segments of the tire industry, including those that manufacture, repair, recycle, sell, service or use new or retreaded tires, and also those suppliers or individuals who furnish equipment, material or services to the industry. Visit www.tireindustry.org for more information.

Overview

Tires are designed and manufactured to meet strict governmental requirements, internal company standards, vehicle performance characteristics and consumer expectations. Modern tire technology blends a unique mix of chemistry, physics and engineering to give consumers a high degree of tire performance that provides safety, reliability, efficiency, long wear and comfort. Tires are manufactured, inspected and tested to assure consumer safety and satisfaction. As a result, properly cared-for tires will provide a longer service life.

Tire Construction and Terminology

Nearly all passenger and light truck tires are radial ply construction that provides sidewall flexibility with body cords that run across the tire nearly perpendicular to the beads. Radial tires have belt plies with steel and/or other cords laid diagonally under the tread to stabilize and reinforce the tread area during contact with the road. See Figure 1.

Passenger Tire vs. Light Truck Tire Construction -

Differences between passenger and light truck tire construction are due to their different uses and operating conditions. Compared to passenger tires, light truck tires usually operate at higher inflation pressures and carry greater loads on a regular basis. Light truck tires are typically designed for more severe service such as in commercial vehicle applications or for off-road use. In order to meet these performance needs, light truck tires may have additional components/layers and heavier-duty materials. As a result, light truck tires tend to be heavier than passenger tires.

Rubber Compounding - Rubber compounding is a complex science of mixing different raw materials together to produce rubber compounds with specific characteristics. Rubber compounds differ due to their location and functional purpose in the tire. Example: Outside tread compound provides traction and treadwear characteristics. Although rubber is the main material used for making tires, there are a number of other materials used as well. These materials are combined with specific rubber compounds in the different components that make up the tire's construction.

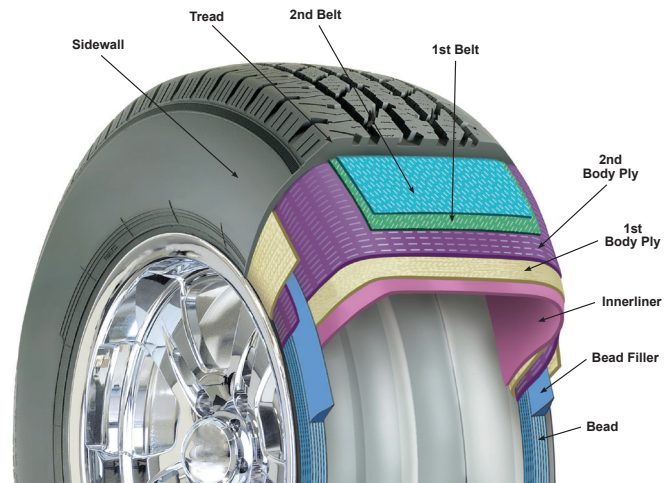

FIGURE 1: Tire Cutaway
Typical Construction Features

Body Ply - Most tires have one or two body plies, each typically comprised of polyester, rayon, or nylon cords within a rubber layer. Body plies function as the structure of the tire and provide the strength to contain the inflation pressure.

Bead - Tire bead bundles (usually strands of wire) secure the tire to the wheel.

Bead Filler - A rubber compound placed above the bead bundle that may be used between the body plies which wrap around the bead to tune ride and handling characteristics.

Belts - Typically, two belts with steel cords laid at opposing angles. Belts provide stability to the tread area of the tire, which contributes to wear, handling and traction.

Innerliner - A rubber compound used to retain the inflation pressure inside the tire.

Sidewall - A rubber compound used to cover the body plies on the sides of the tire, which provides abrasion, scuff and weathering resistance.

Tread - The tread rubber compound and tread pattern provide grip and abrasion resistance contributing to traction and treadwear.

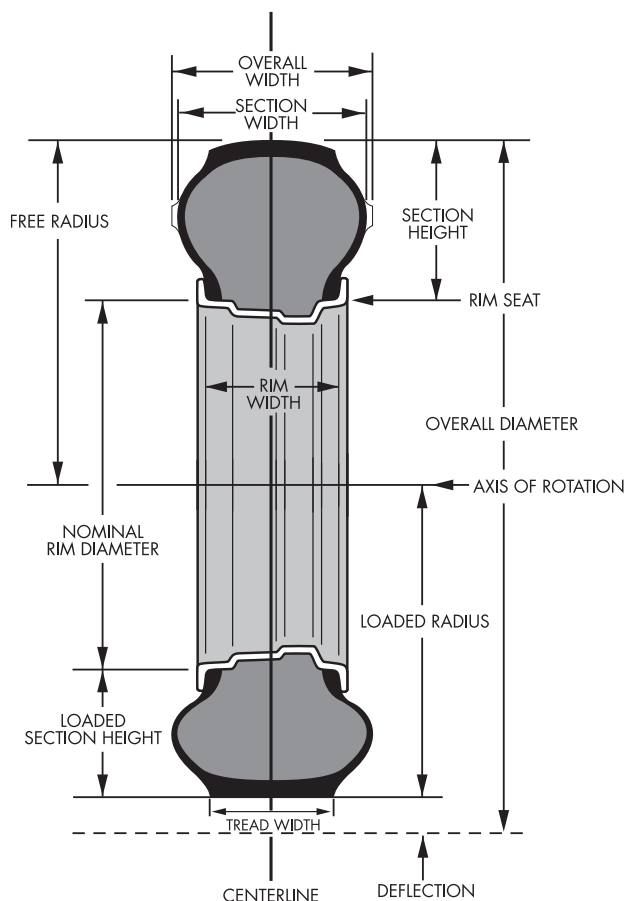

FIGURE 2: Cross-Section of Tire and Rim

Section Height - The height of a new tire from the nominal rim diameter to the top of the tread.

Section Width - The width of a new tire including normal sidewalls, but not including protective side ribs, bars, or other decorations.

Overall Diameter - Twice the section height (unloaded) plus the nominal rim diameter.

Rim Width - The measurement on the inside of the rim between the two flanges.

Rim Diameter Code - The nominal rim diameter in inches.

Tire Size Designations

Size designation systems presently in use:

- P-Metric
- Metric (a.k.a. Euro-Metric)*
- LT-Metric
- LT High Flotation
- LT Numeric
- European Commercial Metric (C-Type)*
- ST Special Tire for Trailers
- T-Type Temporary Spare

Size designations usually include letters which have the following meanings:

- P = P-Metric (Passenger)
- LT = Light Truck
- C = European Commercial (Light Duty)
- ST = Special Tire for Trailers
- T = Temporary Spare
- R = Radial Construction
- F = Self-Supporting, Runflat
- D = Diagonal (Bias) Construction
- B = Belted Bias Construction

Other letters denoting speed symbols such as M, N, P, Q, R, S, T, U, H, V, W, Y, (Y), Z, etc., may appear in the tire size designation or service description. (See "Tire Service Description" on p. 9 for more information.)

* Metric tires do not have an alpha character prefix in the size designation.

Passenger Tire Examples:

P-Metric

P265/70R16				
P	265	70	R	16
P-metric	Nominal Cross-section Width (millimeters)	Ratio of Height to Cross-section Width (aspect ratio)	Radial Construction	Rim Diameter Code

P225/50R15 90H					
P	225	50	R	15	90H
P-metric	Nominal Cross-section Width (millimeters)	Ratio of Height to Cross-section Width (aspect ratio)	Radial Construction	Rim Diameter Code	Load Index & Speed Symbol (Service Description)

P205/60ZR15					
P	205	60	Z	R	15
P-metric	Nominal Cross-section Width (millimeters)	Ratio of Height to Cross-section Width (aspect ratio)	Speed Symbol	Radial Construction	Rim Diameter Code

Metric (a.k.a. Euro-Metric)

225/45R17 91H				
225	45	R	17	91H
Nominal Cross-section Width (millimeters)	Ratio of Height to Cross-section Width (aspect ratio)	Radial Construction	Rim Diameter Code	Load Index & Speed Symbol (Service Description)

T-Type Temporary Spare

T115/70*15				
T	115	70	*D or R	15
Temporary Spare	Nominal Cross-section Width (millimeters)	Ratio of Height to Cross-section Width (aspect ratio)	D (Diagonal/Bias) or R (Radial) Construction	Rim Diameter Code

NOTE: Tire size designations without service descriptions are no longer in general use.

Light Truck Tire Examples*:

LT-Metric

LT265/75R16 Load Range E					
LT	265	75	R	16	E
Light Truck	Nominal Cross-section Width (millimeters)	Ratio of Height to Cross-section Width (aspect ratio)	Radial Construction	Rim Diameter Code	Load Range

LT235/85R16 120/116Q Load Range E						
LT	235	85	R	16	120/116Q	E
Light Truck	Nominal Cross-section Width (millimeters)	Ratio of Height to Cross-section Width (aspect ratio)	Radial Construction	Rim Diameter Code	Load Index & Speed Symbol (Service Description) (Single/Dual)	Load Range

Flotation

31X10.50R15LT Load Range C					
31	10.50	R	15	LT	C
Overall Diameter (inches)	Nominal Cross-section Width (inches)	Radial Construction	Rim Diameter Code	Light Truck	Load Range

LT Numeric

7.50-16LT Load Range D				
7.50	-	16	LT	D
Nominal Cross-section Width (inches)	Non-radial Construction (bias)	Rim Diameter Code	Light Truck	Load Range

European Commercial Metric (C-Type)

225/70R15C 112/110R					
225	70	R	15	C	112/110R
Nominal Cross-section Width (millimeters)	Ratio of Height to Cross-section Width (aspect ratio)	Radial Construction	Rim Diameter Code	European Commercial (Light Duty)	Load Index & Speed Symbol (Service Description) (Single/Dual)

ST Special Tire for Trailers **

ST225/75R15 Load Range D					
ST	225	75	R	15	D
Special Tire for Trailers	Nominal Cross-section Width (millimeters)	Ratio of Height to Cross-section Width (aspect ratio)	Radial Construction	Rim Diameter Code	Load Range

NOTE: Tire size designations without service descriptions are no longer in general use.

* It is common for P-Metric and Metric tire sizes to be placed on pickups, vans, sport utility vehicles, and other vehicles that might be perceived as a "light truck." Check to see which type of tire is specified for the vehicle. For more information, see Chapter 3, "Tire Replacement Guidelines."

** Tires designed specifically for trailer use in highway service.

The Sidewall Story

Tires have very useful information molded onto their sidewall. It shows the brand and model name of the tire, its size, whether it is tubeless or tube type, the maximum load and the maximum inflation, safety warning(s), and much more. Figures 5 and 6 (on p. 7 and 8) show typical information on the sidewall of passenger car and light truck tires.

P225/60R16 97T - This marking indicates a size designation with service description for a P-metric passenger tire (section width, aspect ratio, construction and rim diameter). An aspect ratio number, typically ranging from 30 to 80, in a tire size designation indicates the ratio of the tire section height to section width. Aspect ratios are also referred to as "series" and "profile" numbers. In the example below of a tire with an aspect ratio of 60, the section height of the tire is 60% of the section width. See Figure 3.

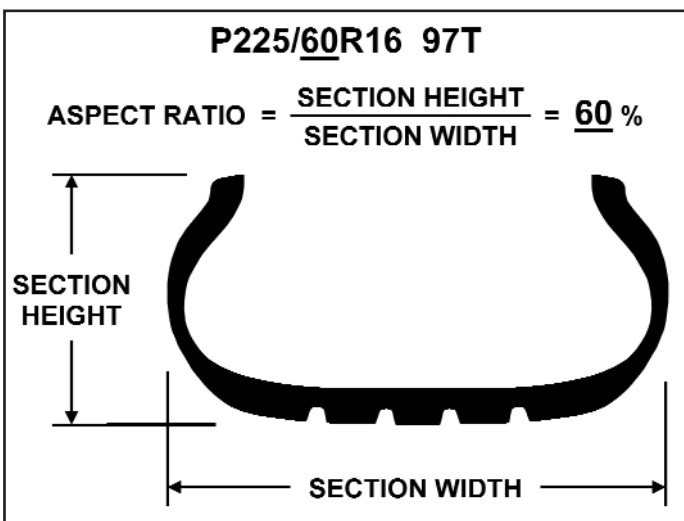

FIGURE 3: Aspect Ratio

SERVICE DESCRIPTION - Includes the load index (numeric) and speed symbol (alpha character). In the example above, "97" is the load index; "T" is the speed symbol. The numeric load index is a code generally ranging from 50-129 that represents the maximum load carrying capacity. Alpha speed symbols represent the speed capability (see p. 9 for more information).

RADIAL - A tire with a radial construction must show the word "RADIAL" on the sidewall. A radial tire is also delineated by the character "R" in the size designation.

PLIES/FABRIC INFORMATION - The ply/fabric information identifies the number of plies and type of cord materials in the tire tread and sidewall areas.

NOTE

The recommended inflation pressure on a vehicle tire placard is based on a number of factors (such as load). Therefore, it may not be the same as the maximum inflation pressure molded on the tire's sidewall. For example, the following maximum inflation pressures may be specified on passenger tires:

- Standard Load tires - 240 kPa (35 psi), 250 kPa (36 psi), 300 kPa (44 psi), or 350 kPa (51 psi)
- Extra Load tires - 280 kPa (41 psi), 290 kPa (42 psi), or 340 kPa (50 psi)

In other words, the pressure indicated on the tire sidewall is the **MAXIMUM** allowed in the tire, irrespective of the vehicle or the load. It is not to be used exclusively for setting pressure for any specific vehicle.

MAX. LOAD 730 kg (1609 lbs) AT 300 kPa (44 psi)

MAX. PRESSURE - Indicates maximum load and maximum cold inflation pressure of the tire. Sidewall markings are given in both metric and English units. Follow tire inflation pressure recommendations on the vehicle tire placard, certification label, or in the owner's manual.

DOT TIRE IDENTIFICATION NUMBER - The "DOT" symbol certifies the tire manufacturer's compliance with U.S. Department of Transportation (U.S. DOT) tire safety performance standards. Next to these letters is the tire identification number (TIN) - also known as the tire "serial" number. Since the year 2000, the last four digits are numbers identifying the week and year of manufacture (Example: "0312" means third week of the year 2012).

All tires produced after September 2009 must have the full TIN on the intended outboard side of the tire and at least a partial TIN on the other sidewall. The partial TIN does not include the date code.

Over the years and in the future, the TIN found on the tire may be different. See Figure 4 on p. 6 for an explanation of various formats used, including examples interpreting the date code.

NOTE

The DOT TIN is necessary to register a tire with the manufacturer for purposes of warranty and recall communication. See "Tire Registration and Recall Information" on p. 10.

TIN Regulation Effective Date	DOT Symbol	Mfr. ID / Plant Code	Tire Size Code	Mfr. Tire Type / Descriptive Code	Week	Year	Date of Manufacture
Original Regulation	DOT	XX	XX	XXXX <small>(OPTIONAL)</small>	XX	X	025 2 nd week of 1995 <small>(possibly 1985 or 1975)</small>
July 2, 2000	DOT	XX	XX	XXXX <small>(OPTIONAL)</small>	XX	XX	0908 9 th week of 2008
April 13, 2015	DOT	XX	XX	XXXX <small>(OPTIONAL)</small>	XX	XX	4815 48 th week of 2015
either type of TIN is permissible	DOT	XXX	XXXXXX		XX	XX	3218 32 nd week of 2018
April 13, 2025	DOT	XXX	XXXXXX		XX	XX	2325 23 rd week of 2025

FIGURE 4: DOT TIN Description

TUBELESS - The tire must be marked either “tubeless” or “tube type.”

M + S - This mark is commonly found on “all season” tires. In several formats, the letters “M” and “S” indicate the tire is intended for limited mud and snow service. Other formats include: “MS,” “M/S,” or “M&S.” Refer to USTMA Tire Information Service Bulletin, Vol. 10, “USTMA Snow Tire Definition for Passenger and Light Truck Tires.”



MOUNTAIN SNOWFLAKE SYMBOL - This mark is commonly found on dedicated winter/snow tires. Tires that meet the USTMA definition for passenger and light truck tires for use in severe snow conditions are marked on at least one sidewall with the letters “M” and “S” (as stated above) plus a pictograph of a mountain with a snowflake, as shown here. Refer to USTMA Tire Information Service Bulletin, Vol. 37, “USTMA Definition for Passenger and Light Truck Tires for Use in Severe Snow Conditions.”

TREADWEAR 600 TRACTION A TEMPERATURE B - Treadwear, traction, and temperature are quality grades established and required by U.S. DOT under the Uniform Tire Quality Grading Standards (UTQG). These standards are only applicable to passenger car tires with some exclusions. See p. 10 for a more detailed explanation on UTQG.

The following pertains to the Light Truck Sidewall Example shown in Figure 6 on p. 8. Other markings on a light truck tire sidewall have the same meanings as those defined for passenger car tires.

LT245/75R16 LOAD RANGE E - This marking indicates that the size designation is for a metric light truck tire with a Load Range “E.” The load range identifies the tire’s load and inflation limits.

SERVICE DESCRIPTION - Includes the load index (numeric) and speed symbol (alpha character). In the light truck sidewall illustration, “120/116” are the load indices for single/dual application; “Q” is the speed symbol. The numeric load index is a code generally ranging from 50-129 that represents the maximum load carrying capacity. In the light truck example, single and dual application load indices are listed. Alpha speed symbols represent the speed capability. See p. 9 for more information.

MAX LOAD SINGLE 1380 kg (3042 lbs) AT 550 kPa (80 psi) COLD indicates the maximum load of the tire and corresponding maximum cold inflation pressure for that load when used as a single. Sidewall markings are given in both metric and English units. Follow tire inflation pressure recommendations on the vehicle tire placard, certification label, or in the owner’s manual.

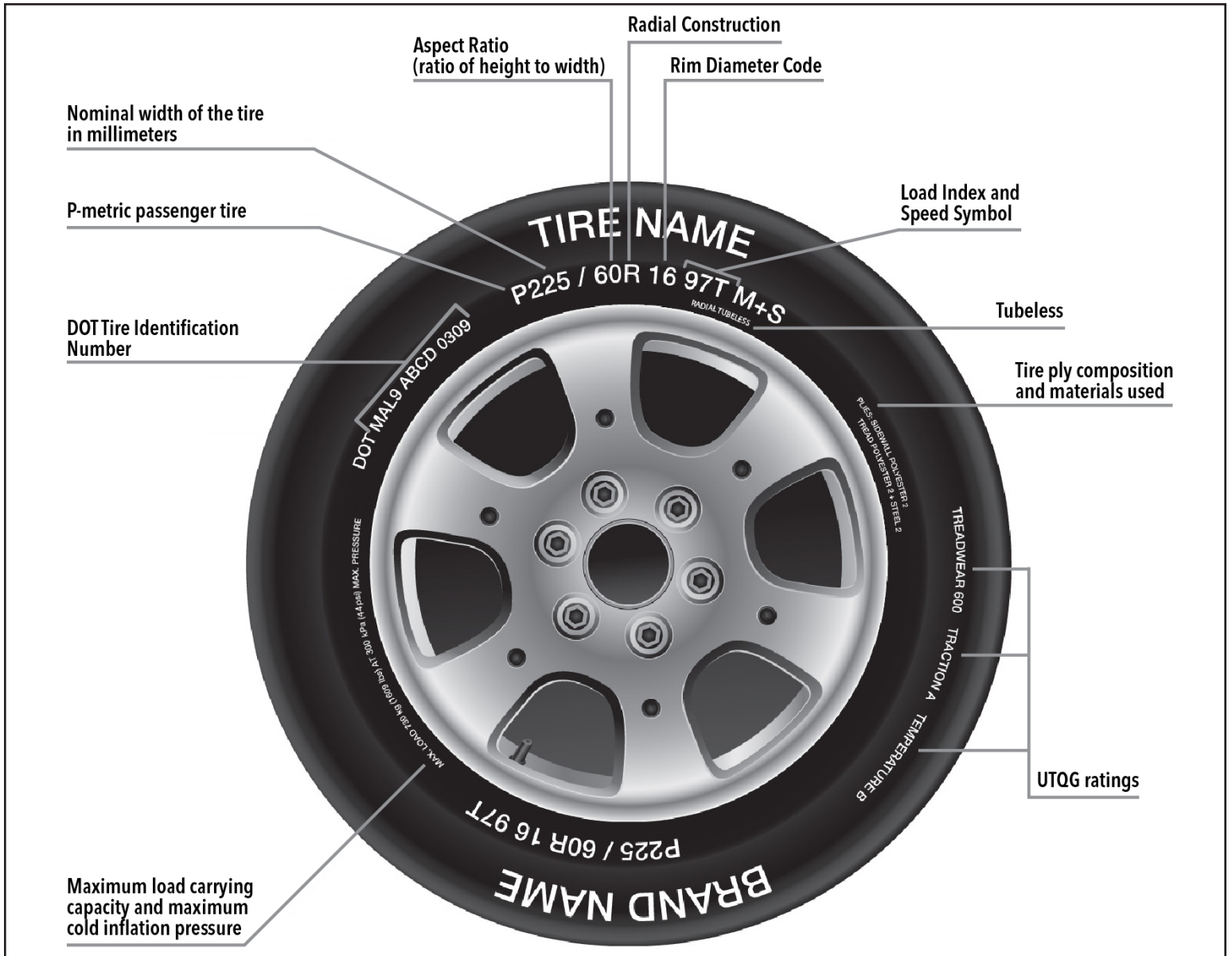

FIGURE 5: Passenger Tire Example

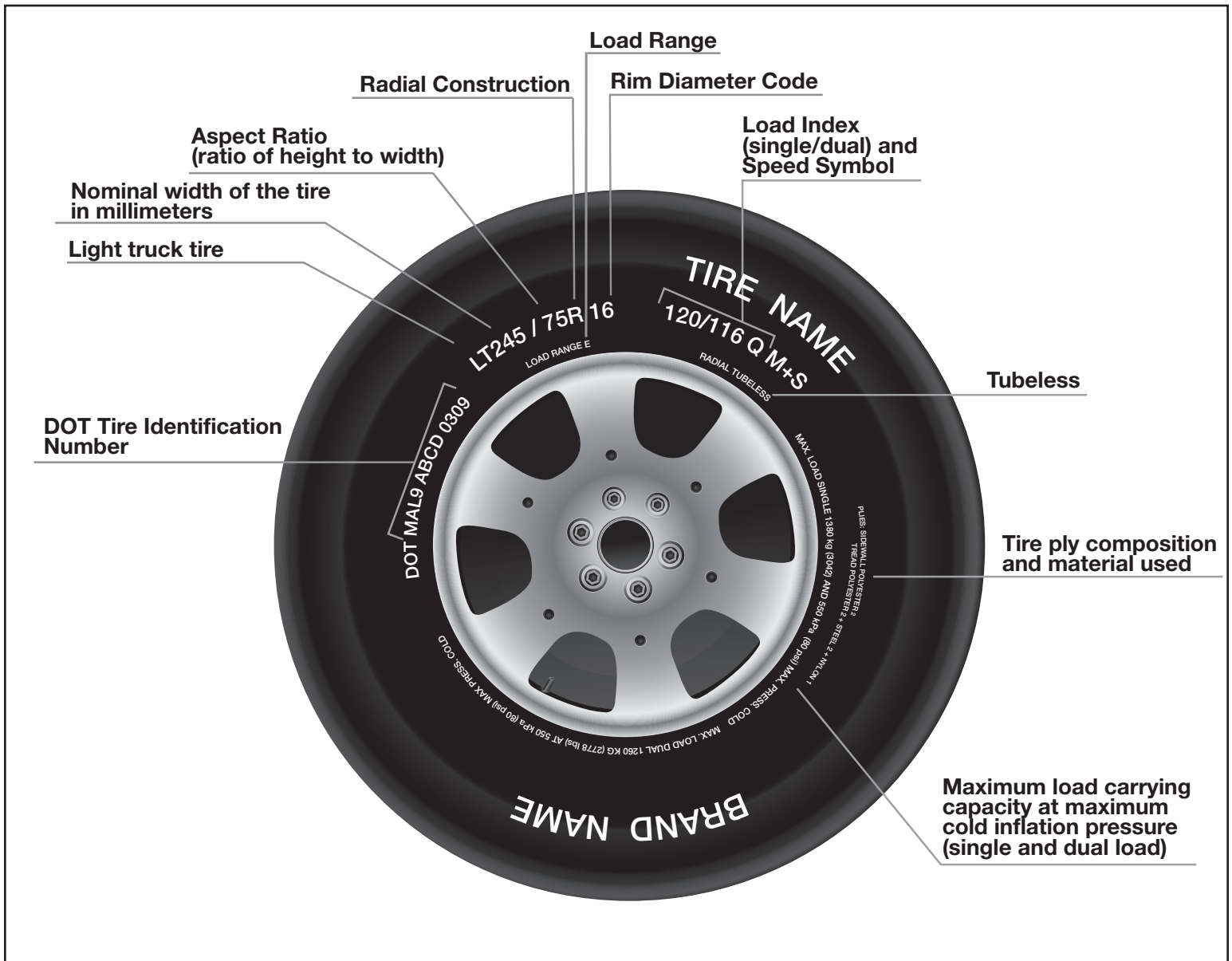

FIGURE 6: Light Truck Tire Example

MAX LOAD DUAL 1260 kg (2778 lbs) AT 550 kPa (80 psi) COLD indicates the maximum load of the tire and corresponding maximum cold inflation pressure for that load when used in a dual configuration. Sidewall markings are given in both metric and English units. Follow tire inflation pressure recommendations on the vehicle tire placard, certification label, or in the owner’s manual.

Tire Service Description

Load Index - The load index is a numerical code associated with the maximum load a tire can carry at the speed indicated by its speed symbol under specified service conditions up to 130 mph (210 km/h). For speeds in excess of 130 mph (210 km/h), the actual load on the tire shall be reduced in accordance with tire selection. For detailed information, refer to the appropriate standards manual (such as The Tire and Rim Association Yearbook) for the vehicle load adjustment (based on speed) for V, W, Y, and ZR rated tires.

Tires with the same load index, regardless of the tire size, may carry the same load, but not always, and they may require different inflation pressures. In addition, some tire sizes are available in more than one load index. Refer to Table 1 for different examples. The load index may not be used independently to determine replacement tire acceptability for load capacity. An equal or greater load index does not always correspond to equal or greater capacity at all inflation pressure settings, particularly when comparing P-metric and metric passenger car tires.

Speed Symbol - The speed symbol in a tire service description is also known as a “speed rating.” See Table 2. The speed symbol indicates the speed category at which the tire can carry a load corresponding to its load index under specified service conditions. Speed ratings are based on laboratory tests that relate to performance on the road, but are not applicable if tires are underinflated, overloaded, worn out, damaged, or altered.

Although a tire may be speed rated, USTMA does not endorse the operation of any vehicle in an unsafe

or unlawful manner. Furthermore, tire speed ratings do not imply that a vehicle can be safely driven at the maximum speed for which the tire is rated, particularly under adverse road and weather conditions or if the vehicle has unusual characteristics. Consult the tire manufacturer for speed capability when there is no service description or speed symbol marked on the tire.

	Speed Symbol	Speed Rating	Speed Category*	MPH	KM/H
		M	M		81
	N	N		87	140
	P	P		93	150
	Q	Q		99	160
	R	R		106	170
	S	S		112	180
	T	T		118	190
	U	U		124	200
	H	H		130	210
	V	V		149	240
ZR**	W	W		168	270
	Y	Y		186	300
	(Y)	--		>186	>300

* In standardized laboratory tests that relate to highway speeds. Actual tire speed and performance capability depend on factors such as inflation pressure, load, tire condition, wear, and driving conditions.

** Any tire having a maximum speed capability above 149 mph (240 km/h) may, at the tire manufacturer’s discretion, include a “Z” in the size designation (i.e. P275/40ZR17). For tires having a maximum speed capability above 186 mph (300 km/h), a “Z” must appear in the size designation and must include a service description with a “(Y).”

Consult the tire manufacturer for speed capability when there is no service description or speed symbol marked on the tire.

Examples:
 P275/40ZR17 max speed > 149 mph - consult tire mfr.
 P275/40R17 93W max speed = 168 mph
 P275/40ZR17 93W max speed = 168 mph
 P275/40ZR17 93Y max speed = 186 mph
 P275/40ZR17 (93Y) max speed > 186 mph - consult tire mfr.

TABLE 2: Speed Symbols

		Load Capacity (lbs.) at Various Inflation Pressures						
Size	Load Index	26 psi (180 kPa)	29 psi (200 kPa)	32 psi (220 kPa)	35 psi (240 kPa)	38 psi (260 kPa)	41 psi (280 kPa)	44 psi (300 kPa)
P205/65R15	92 (SL)	1213	1279	1334	1400	1400	1400	1400
P205/60R16	92 (SL)	1069	1157	1257	1389	1389	1389	1389
205/55R16	90 (SL)	1014	1102	1190	1279	1323	1323	1323
205/55R16	91 (SL)	1047	1135	1224	1312	1356	1356	1356
205/55R16	94 (XL)	1003	1102	1179	1268	1356	1433	1477

TABLE 1: Examples of Tire Size and Load Index Value Differences

Uniform Tire Quality Grading Standards for Passenger Car Tires

The National Highway Traffic Safety Administration (NHTSA) established the Uniform Tire Quality Grading Standards (UTQG). Refer to Code of Federal Regulations: 49 CFR 575.104, a way to assist the consumer to compare various tires. UTQG applies to the vast majority of passenger car tires (excluding tires such as winter-type snow tires). See Figure 7.

NHTSA sets the standards that rate the relative performance of tires based on three criteria: treadwear, traction and temperature. The grades are molded on the tire sidewall. Replacement tires have a label affixed to the tread that lists and explains these grades. A vehicle's engine type, transmission type, gear ratios, driving styles, road surface, inflation pressure, etc. can affect actual performance of the tire from one vehicle to another.

NOTE

In addition to the UTQG standards, all passenger car tires must conform to federal performance safety requirements. Refer to Code of Federal Regulations: 49 CFR 571.139.

The UTQG tire characteristics are as follows:

Treadwear - The treadwear grade is a comparative rating based on the wear rate of the tire when tested under controlled conditions on a specified government test course. In the example shown, the treadwear grade is 600, which means it would wear twice as well on the government course as a tire graded 300. The relative performance of tires depends upon the actual conditions of their use and may depart significantly from the norm due to variations in driving habits, service practices and differences in road characteristics and climate.

Traction - The traction grades, from highest to lowest, are AA, A, B, and C and they represent the tire's ability to stop on wet pavement as measured under controlled conditions on specified government test surfaces of asphalt and concrete. The traction grade assigned is based on braking (straight ahead) traction tests and does not include cornering (turning) traction.

Temperature - The temperature grades are A (the highest), B and C, representing the tire's resistance to the generation of heat and its ability to dissipate heat when tested under controlled conditions on a specified indoor laboratory test

wheel. The temperature grade is established for a tire that is properly inflated and not overloaded. Excessive speed, underinflation, or overloading, either separately or in combination, can cause heat buildup which may result in tire damage and/or tire failure.



FIGURE 7: UTQG Tire Marking Example

Sidewall Marking for Retread Tires

Applicable retread tires, which operate on public roads in the United States, are permanently marked on the sidewall with "DOT-R" and followed by a 7 to 13 character Tire Identification Number (TIN). If the original new tire was certified by the manufacturer to the applicable safety standards and regulations, the original "DOT" certification mark and the new tire TIN may remain on the tire casing after retreading, along with the retreader's TIN.

If a speed rated tire is retreaded, the speed rating is no longer valid.

NOTE

Don't sell, use or retread tires whose original DOT marking/serial number has been removed, obliterated or branded over.

Tire Registration and Recall Information

Registration of tires is an important step to complete when placing them into service. Registration enables manufacturers to contact the consumer in the event of a recall. At the point of sale, consumers should be provided a tire registration card. This information should be completed and submitted as soon as possible. USTMA tire manufacturer members also provide online tire registration forms that can be submitted electronically.

Consumer contact information and DOT Tire Identification Numbers (TIN) are necessary for registration. In addition, DOT TINs are necessary to determine whether a tire is subject to a recall. Visit www.USTires.org for links to USTMA member tire registration websites and for a tire recall lookup tool.

Overview

Tires are designed and manufactured with advanced technology and great care to provide thousands of miles of excellent service. For maximum safety, performance and service life, they must be maintained properly.

THE MOST IMPORTANT FACTORS IN TIRE SAFETY, PERFORMANCE AND SERVICE LIFE ARE:

- PROPER TIRE SIZE, TYPE, AND LOAD CAPACITY (OR LOAD RANGE)
- PROPER INFLATION PRESSURE
- PROPER VEHICLE LOADING
- REGULAR TIRE ROTATION
- REGULAR INSPECTION
- PROPER TIRE REPAIR
- VEHICLE CONDITION, ALIGNMENT AND MAINTENANCE
- GOOD DRIVING HABITS

This chapter will address these and other factors relative to the care and service of passenger car and light truck tires.

! **WARNING**

Driving on tires with improper inflation pressure is dangerous.

- Under inflation causes excessive heat build-up and internal structural damage.
- Over inflation makes it more likely for tires to be cut, punctured or broken by sudden impact.

These situations can cause a tire failure, including tread/belt separation, even at a later date, which could lead to an accident and serious personal injury or death.

Consult the vehicle tire placard, certification label or the owner's manual for the recommended inflation pressures.

Proper Tire Inflation

The recommended inflation pressures for tires are typically measured in pounds per square inch (psi) and are indicated on the vehicle tire placard, certification label or in the owner's manual. Never set tire inflation pressures below the recommended inflation pressure found on the vehicle

tire placard, certification label or owner's manual. See Figure 8. Under inflation causes excessive heat build-up and internal structural damage that may lead to a tire failure, even at a later date. Do not exceed the maximum inflation pressure shown on tire sidewall. Over inflated tires (over the maximum molded on the tire sidewall) are more likely to be cut, punctured or damaged by sudden impact from hitting an obstacle, such as a pothole.

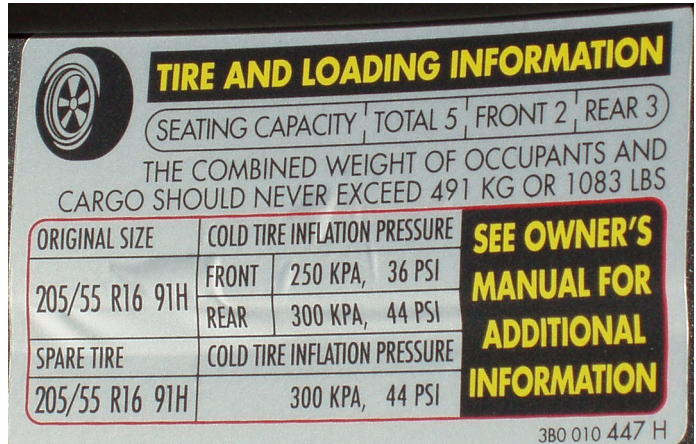

FIGURE 8: Example of a Vehicle Tire Placard

Proper Inflation is Critical - Inflation pressure enables a tire to support the load and to control the vehicle, therefore proper inflation is critical. With the right amount of inflation pressure, the vehicle and the tires will achieve their optimum performance. In addition to tire safety, this means your tires will wear longer and improve vehicle fuel consumption. Note that some vehicles may have different cold inflation pressures for tires on the front and rear axles.

NOTE

The pressure indicated on the tire sidewall is the maximum allowed in the tire, irrespective of the vehicle. Follow the vehicle manufacturer's recommendations for inflation pressure found on the vehicle tire placard, certification label or in the owner's manual.

It is impossible to determine whether radial tires are properly inflated just by looking at them (see Figure 9 on p. 12). You must use a tire gauge to properly check the inflation pressure. Motorists should have their own gauge and keep it in the vehicle.



Properly Inflated

50% Underinflated

FIGURE 9: One of these tires is dangerously underinflated. You cannot tell just by looking.

Check inflation pressure with an accurate tire gauge. A gauge calibrated in 1 psi increments up to 60 psi is sufficient for most passenger tires. A dual head gauge calibrated in 2 psi increments up to 100 psi is sufficient for light truck tires. Even if it is difficult to check the inflation pressures of inside tires in dual fitments, it is imperative that these inflation pressures be checked and properly maintained because the inside dual tires are subjected to more severe operating conditions, such as:

- High heat exposure, due to close proximity to the brakes
- Lower air circulation to assist in cooling the tires
- Crowned road surfaces (which can cause inside dual tires to support more of the load than the outside dual tires)

When to Check Inflation Pressure - Check inflation pressure when tires are cold, that is, when the vehicle has been parked for at least three hours or has been driven less than one mile at moderate speed. The inflation pressure in all tires, including the spare tire and inside duals, should be checked with an accurate tire gauge at least once per month. Additional checks should be made before long trips, carrying heavy loads, towing a trailer and any time high speeds are anticipated. This includes vehicles equipped with a Tire Pressure Monitoring System (TPMS). Maintaining proper inflation pressure maximizes fuel economy and optimizes overall tire performance.

Never “bleed” or reduce inflation pressure when tires are hot from driving, as it is normal for pressures to increase above recommended cold pressures. If a hot tire pressure reading is at or below recommended cold inflation pressure it may be dangerously under inflated. In this case, immediately determine the cause and/or have the tire checked by a tire service professional.

Passenger and light truck tires may lose 1 to 2 psi inflation pressure per month under normal conditions and 1 to 2 psi for every 10°F temperature drop. If a tire continually loses more than 2 psi per month, have it checked by a tire service professional.

Significant changes in altitude or temperature at which a vehicle will regularly operate will result in changes in inflation pressure and will require an inflation pressure check and adjustment.

⚠ WARNING

Inflating an unsecured tire is dangerous. If it bursts, it could be hurled into the air with explosive force resulting in serious personal injury or death.

Never inflate a tire unless it is secured to a vehicle, tire mounting machine or other restraining device.

Continuous Inflation Pressure Loss - Any tire that continually requires re-inflation is a serious safety risk. The cause may be the result of a puncture, road hazard damage, leaking valve, tire mounting damage, or other irregular condition. Continuous use of a tire in an under inflated condition will result in heat build-up and internal tire damage. This may result in a tire failure, including tread/belt separation. Tires that continuously require re-inflation should be inspected thoroughly by a tire service professional and be properly serviced or replaced immediately.

Dual Tire Assemblies - For vehicles equipped with dual tire assemblies (duals), if one of the dual tires becomes significantly underinflated or flat, the other tire will carry the load for both tires, resulting in an overloaded condition. Both tires should be inspected by a tire service professional for damage.

Tire Pressure Monitoring Systems (TPMS) - It is still important to check inflation pressure at least once a month, even on vehicles that are equipped with a TPMS. TPMS are designed to be beneficial and accurate. However, they should not be solely relied on for inflation pressure maintenance since some systems may have limitations, such as:

- Lack of warning of low inflation pressure until one or more tires are as much as 25% below the vehicle manufacturer recommendations.

- May only detect inflation pressure differences between tires (in other words, if all tires are losing inflation pressure at the same rate, it is possible that the TPMS will not adequately warn of inflation pressure loss).
- May not warn of rapid inflation pressure loss in a single tire.

Under inflation (prior to a TPMS warning) is increasingly dangerous at high speeds, heavy vehicle loads, extended distances and at high ambient temperatures.

Spare Tire Inflation Pressure - Full-size and temporary spare tire inflation pressure should be checked monthly and before any long trips. Use an accurate gauge. T-type temporary spare tires require 60 psi (420 kPa). When adjusting inflation pressure in T-type tires, do so in small amounts since the tire is smaller and the pressure level changes rapidly. Do not over inflate.

Valve Caps - Always cover the valve stem with a sealing cap. This helps prevent moisture, dirt and other contaminants from entering the valve core, as well as providing an additional seal.

Inflation Pressure for Off-Road Use - Inflation pressures for tires used in most off-road situations should be the same as those for highway driving. If a lower inflation pressure is used to gain additional flotation/traction at low speeds, the tires must be re-inflated before resuming driving on the highway or at higher speeds, whether on- or off- road.

Using Nitrogen Inflation - Nitrogen may be offered as an alternative to air for tire inflation. Nitrogen is an inert (non-flammable) gas - basically, nothing more than dry air with oxygen removed (air contains about 78% nitrogen). Because of its inert properties, nitrogen is often used in highly specialized service applications and/or demanding environments. For instance, aircraft, mining and commercial/heavy applications use nitrogen to help reduce the risk of internal combustion (fire) if the brake/rim/wheel components overheat. Also, dry nitrogen is used in professional racing to help reduce variation in inflation pressures (caused by moisture) where even small differences in pressure can affect vehicle handling at the extreme limits of performance.

For normal tire service applications, nitrogen inflation is not necessary. However, nitrogen inflation is permissible as its properties may contribute to minor reductions in inflation pressure loss. Nevertheless, several other sources of pressure leaks, such as punctures, tire/rim interface (bead), valve, valve/rim interface, and the wheel, may negate the benefit of nitrogen. If the tire inflation pressure is below the pressure specified on the vehicle tire placard, certification label or

owner's manual, the tire must be re-inflated -- whether with air or nitrogen -- to the proper inflation pressure. Do not operate tires under inflated and/or over loaded.

Depending on nitrogen alone to reduce the requirements for inflation maintenance may lead to under inflated operation which may result in premature tire failure. With the right amount of inflation pressure, the vehicle and tires will achieve their optimum performance. In addition to tire safety, this means your tires will wear longer and improve vehicle fuel consumption.

Nitrogen and air can be mixed in any and all proportions. Nitrogen filled tires can and should have air added whenever nitrogen is not readily available, to maintain proper inflation as specified by the vehicle manufacturer.

For information on storing and handling nitrogen, follow the manufacturer's and/or supplier's safety guidelines.

NOTE

Whether inflated with air or nitrogen, regular inflation pressure maintenance remains critical and necessary. Use of nitrogen alone is not a replacement for regular inflation pressure maintenance.

⚠ WARNING

Under inflation and/or over loading of a tire causes excessive heat build-up and internal structural damage. This may cause a tire failure, including tread/belt separation, even at a later date, which can lead to an accident and serious personal injury or death.

Over loading a vehicle can have other serious safety consequences such as suspension or wheel failure, increased braking distance or brake failure (particularly on steep grades), and adverse vehicle handling/stability.

Consult the vehicle tire placard, certification label and owner's manual for the recommended vehicle load limits and tire inflation pressures.

Tire Loading

To avoid over loading tires, maintain the proper inflation pressure and never exceed the vehicle's load capacity, Gross Axle Weight Ratings (GAWR) or the Gross Vehicle Weight Rating (GVWR) stated on the vehicle tire placard, certification label or the vehicle owner's manual. The vehicle load must also be distributed so that no individual axle, tire or dual assembly is over loaded.

The maximum load for each tire is molded on the tire sidewall (along with the maximum inflation pressure for that load). Never exceed the maximum limits on the tire, rim or wheel assembly.

For improved fuel efficiency, reduce vehicle weight as much as possible by removing unnecessary items from your cargo storage areas (in addition to keeping tires properly inflated).

Consult your vehicle owner's manual for load recommendations and special instructions (such as trailer towing).

Sudden Ride Disturbance or Vibration

If the vehicle experiences a sudden vibration or ride disturbance and/or there is a possibility the tires and/or vehicle have been damaged, gradually reduce speed. Do not abruptly brake or turn. Drive with caution until you can safely pull off the road. Stop and inspect the tire. If the tire is under inflated or damaged, deflate and replace it with the spare tire. If a cause cannot be detected, the vehicle should be towed to the nearest vehicle or tire dealer for an inspection.

Tire Inspection Guidelines

In addition to maintaining inflation, regularly inspect the tire tread and sidewalls for irregular tread wear, cracking, scrapes, bulges, cuts, snags, foreign objects or other damage resulting from use. It is recommended that tires, including the spare, be periodically inspected by a tire service professional during routine maintenance intervals such as oil changes and tire rotations.

Remove any stones, glass, foreign objects, etc. embedded in the tread to prevent damage. Even minor damage can lead to further injury and eventual tire failure. Also, it is a

good practice to check between dual tire/wheel assemblies for foreign objects, like large rocks, that may have become lodged between the tires, especially after off-road service.

Tires with excessive cracking on the tread or sidewall(s) should be removed from service. This is typically caused by under inflation, over loading, improper storage, and/or improper long-term parking.

Replace tires when worn to 2/32" (1.6 mm) depth remaining anywhere on the tread face. For vehicles with a GVWR in excess of 10,000 pounds (4,536 kg), federal regulations state that tires on the front axle should be removed when worn to 4/32" (3.2 mm) tread depth. Refer to Code of Federal Regulations: 49 CFR 570.62 and 49 CFR 393.75(b).

Built-in tread wear indicators or "wear bars," which look like narrow strips of smooth rubber across the tread, will appear on the tire when the tread is worn to 2/32" (1.6 mm), see Figure 10. When a wear bar is flush with the tread surface, the tire is worn out and should be replaced.



FIGURE 10: Tread wear Indicators/Wear Bar. Based on the tread wear indicators on the left side of the tire above, the tire is worn out.

⚠ WARNING

Driving on damaged tires is dangerous. A damaged tire can suddenly fail leading to situations that may result in serious personal injury or death. Tires should be regularly inspected by a qualified tire service professional.

Consumers should check their tire tread and sidewall areas during monthly inflation pressure checks, looking for uneven or irregular tread wear, cuts, cracks, scrapes, snags, bulges, foreign objects or other damage.

A manual published by the Tire Industry Association (TIA) entitled, "Passenger and Light Truck Tire Conditions Manual", may be used by service garages, tire dealers, state motor vehicle inspection stations, etc., as a reference for inspection of tires, rims, and wheels.

Reasons for Tire, Rim/Wheel or Valve Removal - If any of the conditions below are found when inspecting a tire, rim/wheel or valve, the item should be removed from service. (Note: this list is not all-inclusive.)

Tread Conditions

- Worn to 2/32" (1.6 mm) or less anywhere on the face of the tread and/or tread wear indicators showing
- Localized spot wear due to separation
- Cuts, cracks, bulges, or snags in the tread or groove exposing cord or fabric material (excludes repairable conditions)
- Unrepairable punctures

Sidewall Conditions

- Impact break (e.g. rim bruise break)
- Bulges, blisters or deep cuts/cracks
- Excessive sidewall abrasion
- Exposed cords or fabric material

Bead Conditions

- Sharply bent or broken beads or bead wires
- Deep cuts/cracks
- Torn bead area rubber
- Excessive rim flange grooving or severely chafed bead area rubber

Innerliner Conditions

- Exposed body ply cords
- Unrepairable punctures
- Previous improper repairs
- Foreign object damage
- Cracking with visible cord material
- Run flat damage as exhibited by abrasions, cracking, blisters, wrinkles, discoloration, or breakdown of cord material

Rim/Wheel or Valve Conditions

- Any rim/wheel that is bent, dented, cracked, excessively corroded or otherwise damaged
- Damaged valve and/or valve core

Common Types of Tire Damage - Several types of tire damage are covered in this section. However, it is not all-inclusive and should only be used as a general guideline for identifying a variety of damage conditions. Refer to TIA's "Passenger and Light Truck Tire Conditions Manual" for additional information. See Figure 11 on p. 17 for some examples of these conditions.

Under Inflation and/or Over Loading Damage

Under inflation and/or over loading is the leading cause of tire failure, so it is important to maintain inflation pressure and to properly load the vehicle. See "Proper Tire Inflation" on p. 11 and "Tire Loading" on p. 14.

Under inflation and/or over loading of a tire causes excessive heat build-up and internal structural damage. This may cause a tire failure, including tread/belt separation, even at a later date, which can lead to an accident and serious personal injury or death.

It is important to inspect tires for under inflation and/or over loading damage such as internal tire separation, heat discoloration, cracking, rim flange grooving, and localized accelerated treadwear (spot wear).

Road Hazard Damage

Punctures, cuts, snags, etc., can lead to further damage if not repaired in time. The tire must be demounted and carefully inspected to determine whether it is repairable. Some road hazard damage may result in gradual inflation pressure loss. If not corrected as soon as possible, such damage can ruin tires that could otherwise have been repaired. For information on proper tire repair, see "Proper Tire Repair" on page 21.

Impact Damage

Impact damage to the tire may initially show little or no exterior evidence. However, internal damage can progress with additional mileage and eventually cause internal tire separation, detachment or sudden loss of inflation. Impact damage may cause gradual inflation pressure loss. After experiencing an unusual impact, have the tire inspected by a tire service professional.

A rim bruise break (pinch shock) occurs when the tire strikes a rigid object (like a curb or pothole) hard enough to crush the tire's sidewall between the rim flange and the rigid object. Vehicles operated off-road or in areas away from paved roads can encounter many objects that can cause tire damage. Careful inspection of the tires should be made after use in off-road service.

Demounting or Mounting Damage

Tires that have been damaged by improper demounting/mounting procedures may fail prematurely. For instance, a torn bead may cause gradual inflation pressure loss and even lead to internal tire separation. See USTMA wall chart, "Demounting and Mounting Procedures for Passenger and Light Truck Tires." Also see USTMA Tire Information Service Bulletin, Vol. 43, "Avoid Tire Bead Damage on Tire Mounting Machines that Secure the Rim from Underneath."

Ozone Cracking or Weather Checking

Weather checking/ozone cracking can occur during direct and extended exposure to damaging effects of the environment, such as ozone and heat from sunlight. Ozone cracking can also be caused by exposure to electric motors, welding equipment, or other ozone generating sources. Ozone levels should not exceed 0.08 parts per million (ppm).

Tires with severe weather checking/ozone cracking or any cracking extending to the tire casing cords/plies should be removed from service. For more details on storing mounted and unmounted tires, see "Tire Storage Recommendations" on p. 24.

Treating tires with incompatible dressings or harsh cleaning agents will hasten oxidation and result in premature cracking. Always avoid petroleum-based tire dressings/cleaners. Check with the tire manufacturer recommendations for cleaning tires. See "Cleaning Tires" on p. 24.

Tire Service Life

It is important to have tires in good operating condition, thus tires may need to be replaced because of service conditions long before the tread is worn out. To determine if tires, including the spare, should remain in service, it is recommended that they be periodically inspected by a tire service professional during routine maintenance intervals like oil changes and tire rotations. The service life of tires includes their overall condition and vehicle usage factors, not just tread wear. All of these factors should be taken into account when considering tire replacement.

Follow the vehicle and tire manufacturers' specific recommendations, if any, regarding tire service life and replacement. In order to determine the age of the tire, look for the last four digits of the DOT tire identification number. See Figure 4 on p. 6 in Chapter 1, "Basic Tire Information"

for details. For example, a tire with a DOT tire identification number ending with the last four digits of 0309 indicates it was manufactured the 3rd week of 2009.

Tires that have been permanently removed from service should be rendered unserviceable and destroyed so no one else can use them.



Tire Service Life is Not Determined by Chronological Age

Age - Tires are composed of various materials, including rubber, having performance properties essential to the proper functioning of the tire. These component properties evolve over a combination of time, service and storage conditions. For each individual tire, this change is affected by many elements such as temperature, storage conditions, and conditions of use (e.g., load, speed, inflation pressure, impacts and road hazard injury) to which a tire is subjected throughout its life. Since service and storage conditions vary widely, accurately predicting the service life of any specific tire based on calendar age is not possible. USTMA is not aware of scientific or technical data that establishes or identifies a specific minimum or maximum service life for passenger and light truck tires. However, in some cases a tire or vehicle manufacturer may make a specific tire replacement recommendation regarding its products. If so, the consumer should consult the manufacturer with any questions with regard to following the recommendation. Furthermore, any such recommendation should not be considered a minimum service life for the tire.

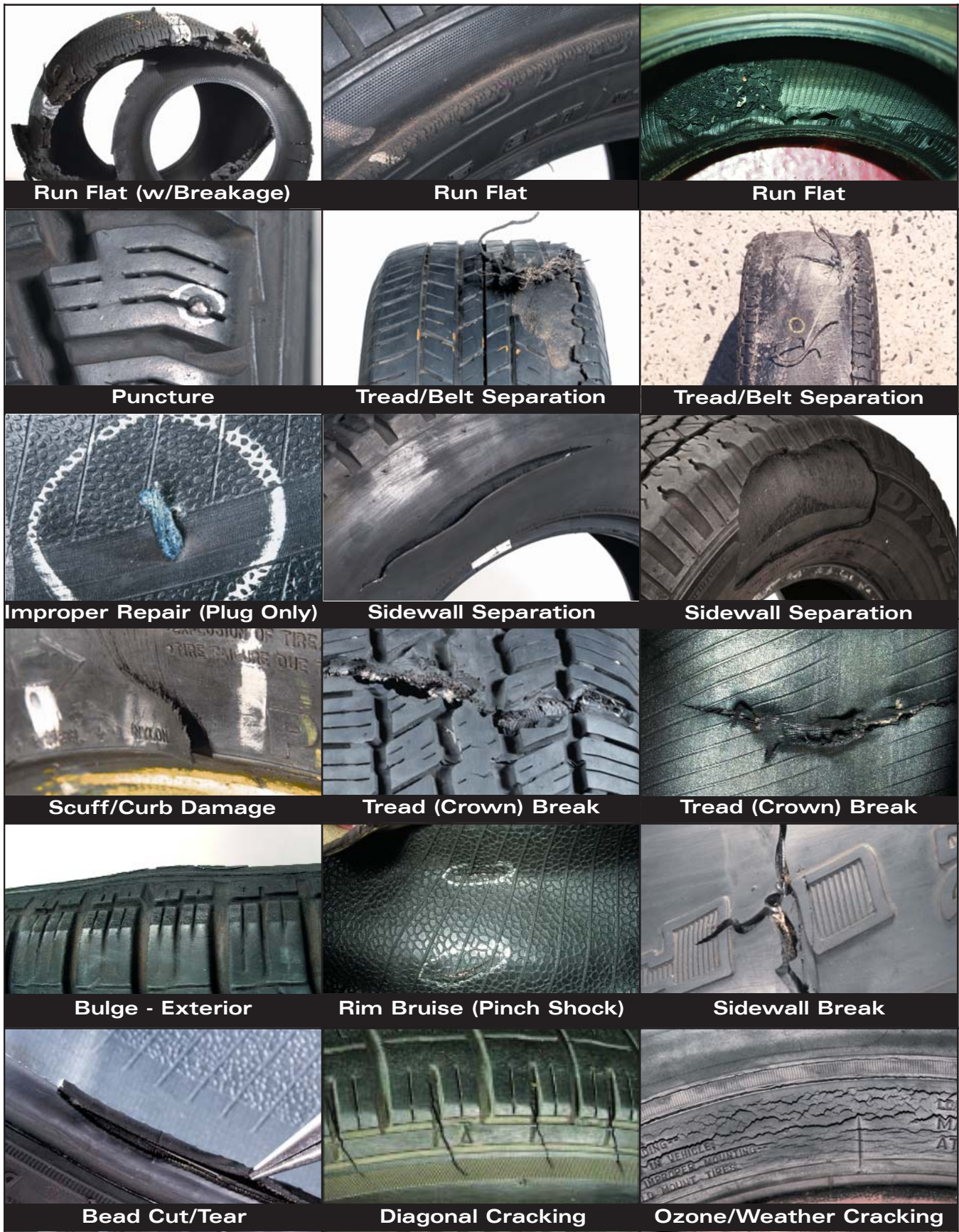
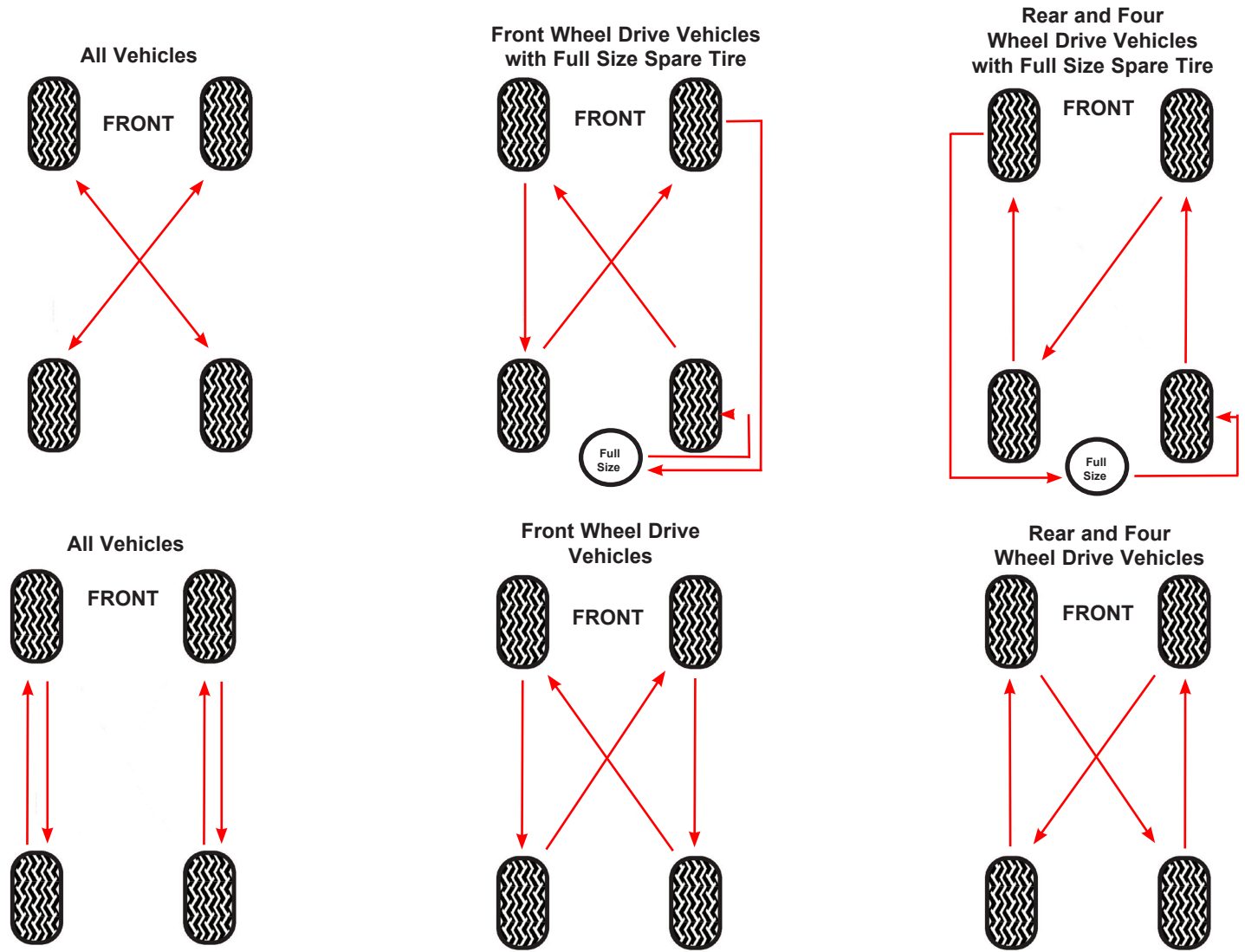

FIGURE 11: Common Examples of Tire Damage



Vehicles with Dual Rear Wheels (Six-Tire Rotation)

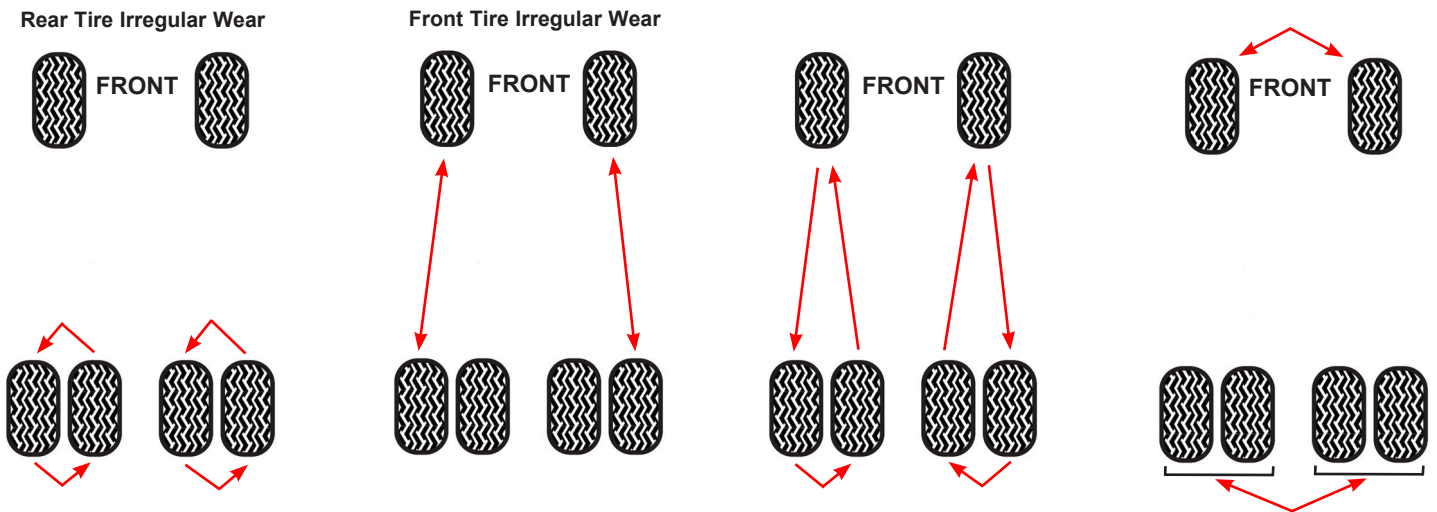

FIGURE 12: Typical Rotation Patterns When Tires are the Same Size and Type

Tire Rotation

Before rotating tires, always consult the vehicle and/or tire manufacturer for specific recommendations regarding rotation. The purpose of regularly rotating tires is to prolong tread life and promote more uniform tread wear for all tires on a vehicle. If no rotation period is specified, tires should be rotated every 5,000 to 8,000 miles (or per the tire manufacturers recommendations) or at any sign of uneven wear. The first rotation is the most important. Going for extended mileage, where the tires are not rotated, can result in a situation where a pair of tires wears prematurely and unevenly. If tires show uneven tread wear, check for and correct any misalignment, imbalance, or other mechanical problems before rotation.

Any vehicle showing a tendency for wear differential should have tires rotated more often. Always consult the vehicle and/or tire manufacturer for specific rotation instructions.

Many vehicle manufacturers recommend replacing all tires on the vehicle at the same time. This makes rotation even more important for maintaining uniform tread depth and optimum tread wear of the entire set.

In the absence of vehicle manufacturer rotation recommendations, follow the rotation patterns in Figure 12 on p. 18. Note that certain types of tires cannot be rotated in the manners shown. Such tires may include directional and asymmetrical tires. Also, some vehicles may have different sized tires mounted on the front and rear axles, and these different sized tires have rotation restrictions. For these special cases, check the recommendations in the vehicle owner's manual for proper rotation.

When tires are rotated, the inflation pressures must be adjusted for the tires' new positions in accordance with the vehicle manufacturer's recommendations; see the vehicle tire placard, certification label, or owner's manual. Under inflation may result in rapid and/or abnormal treadwear, improper vehicle handling and decreased fuel economy. Over inflation can also result in rapid and/or abnormal tread wear, decreased traction and premature wear of suspension components. Improper tire inflation may cause a tire failure, including tread/belt separation, even at a later date, which can lead to an accident and serious personal injury or death. See "Proper Tire Inflation" on p. 11.

Do not include a "Temporary Use" or T-type spare tire in any of these rotation patterns. If the vehicle has a matching full-size spare tire, it is recommended that it be included in the

tire rotation. Use one of the tire rotation patterns illustrated, inserting the full-size spare at the right rear position. Always check and adjust the inflation pressure of the full size spare when incorporating it into the rotation scheme.

Conditions Affecting Tread Wear

Service Conditions

Tread wear is affected by many different vehicle operating conditions. Abnormal wear typically results from a combination of unsatisfactory conditions and may make an accurate diagnosis of the cause(s) difficult. It is important to identify the emergence of abnormal wear in its early stage and correct the cause before valuable tire treadwear is lost. Most of the causes of abnormal treadwear can be corrected. The causes can include excessive tire stresses due to driving habits, road surfaces, terrain and axle position.

Driving Habits

The way a vehicle is driven has a great deal to do with tread wear and safety. Observe posted speed limits and avoid hard stops, starts and cornering. In addition, avoid potholes, objects on the road, and curbs (such as hitting/forcing the tire against the curb when parking). The rate of wear increases during hard cornering at both high and low speeds due to scuffing caused by lateral forces, particularly on the front tires. Hard acceleration or braking will also cause increased wear due to torque and weight transfer. The tires with the most weight on them, typically the front tires, are doing the most braking.

Road Surfaces/Terrain

Rapid or abnormal tread wear may be caused by abrasive road surfaces such as those with sharp or coarse highway paving materials. Areas that have numerous hills or curves can also lead to accelerated treadwear.

Axle Position

The position of a tire on a vehicle determines what stresses the tire will experience. The tires on the drive axle are affected by acceleration. Depending on the vehicle, this can be the rear axle, the front axle or, in the case of four-wheel drive, both axles. On front-wheel drive vehicles, the front axle also steers the vehicle and performs most of the braking. Free-rolling, rear tires may also experience some abnormal tread wear. Rotating tires on the vehicle may help to minimize abnormal wear.

Maintenance Conditions

There is a close relationship between several mechanical systems on a vehicle and its tires. Tires, wheels, brakes, shock absorbers, drive train, steering and suspension systems, etc., must all function together to perform safely and comfortably and to give optimum tread wear. Improper or inadequate vehicle maintenance can cause tires to wear rapidly and/or abnormally. All of the following maintenance conditions can be adjusted or repaired.

Figure 13 gives examples of different types of abnormal tire wear.

Improper Tire Inflation

For optimum service, use the inflation pressures specified by the vehicle manufacturer on the vehicle tire placard, certification label or owner's manual. Under inflation may result in rapid and/or abnormal tread wear, improper vehicle handling and decreased fuel economy. Over inflation can also result in rapid and/or abnormal tread wear, decreased traction and premature wear of suspension components. Improper tire inflation may cause a tire failure, including tread/belt separation, even at a later date, which can lead to an accident and serious personal injury or death. Check and adjust tire pressure (including the spare) at least once per month with a pressure gauge (see "Proper Tire Inflation" on p. 11).

Vehicle Wheel Misalignment

If the vehicle wheels are not properly aligned, tires will experience stresses as if they were constantly cornering. This will cause increased and abnormal tread wear. A qualified mechanic should correct misalignment of wheels. Front-wheel drive vehicles and those with independent rear suspension require special attention with alignment of all four wheels. For any vehicle, four-wheel alignment can identify problems such as "dog tracking," when the rear tires do not follow in the paths of the front tires. This can also result in abnormal tread wear. The vehicle alignment geometry should be checked periodically as specified by the vehicle owner's manual or if misalignment is suspected.

Lack of Tire Rotation

Tire rotation procedures are established to equalize the tread wear for each tire to prolong tread life. By regularly changing a tire to another position on the vehicle, any abnormal wear patterns that were starting to develop may be corrected. See "Tire Rotation" on p. 19.

Tire and Wheel Assembly Out-of-Balance

A tire and wheel assembly that is out-of-balance can cause abnormal tread wear due to vibration and irregular road contact which may be worse at specific speeds. See p. 29 for information on tire wheel balance.



FIGURE 13: Examples of Abnormal Tread Wear

Damaged Wheels

Damaged wheels can cause a tire to contact the road unevenly and cause abnormal tread wear. Wheel damage may not be visually obvious and should be checked by a tire service professional using proper measuring equipment.

Brakes in Disrepair

If not in proper working order, brakes can grab unevenly and cause abnormal tread wear.

Worn Struts, Shock Absorbers

A worn strut or shock absorber will not properly dampen vehicle motion and cause abnormal tread wear.

Worn or Loose Suspension and Steering Systems and Worn Ball Joints

Excessive wear and looseness anywhere in the suspension and steering systems (such as tie-rod ends and ball joints) can cause tire and wheel assemblies to move in ways in which they were not designed. This will cause rapid and/or abnormal tread wear.

Proper Tire Repair

Tires driven even a short distance while under inflated may be damaged beyond repair. Running a tire under inflated is like running the vehicle's engine without enough oil or coolant. It may seem to work fine for a time, but serious permanent damage has occurred. Adding oil or coolant won't repair engine damage, and adding inflation pressure won't fix tire damage. The tire will remain seriously damaged and can still fail, even after inflation pressure is corrected.

If a tire is losing inflation pressure, a tire service professional should check the tire surface and the valve for the source of the leak(s) by using water or a soap solution prior to demounting the tire from the rim. Mark the injured area and totally deflate the tire. Then remove the tire from the wheel being careful to avoid further damage to the tire, particularly to the bead area. Perform a complete internal inspection.

For vehicles equipped with dual tire assemblies (duals), if one of the dual tires becomes significantly underinflated or flat, the other tire will carry the load for both tires, resulting in an overloaded condition. Both tires should be inspected by a tire service professional for damage. See "Tire Inspection Guidelines" on p. 14.



Puncture repairs are limited to the tread area as generally depicted above. **DO NOT** make repairs where the injury damage extends into the shoulder/belt edge area OR where the injury extends at an angle into the shoulder area. If there is any question that the injury extends into the shoulder/belt edge area, then the tire must be scrapped.

FIGURE 14: Puncture Repair Area

Always read, understand and follow the USTMA wall chart "Puncture Repair Procedures for Passenger and Light Truck Tires" which covers the proper repair procedures for passenger and light truck tires through Load Range "E." Never repair a tire with an injury that is greater than 1/4 inch (6 mm) in diameter. Do not repair an injury outside the puncture repair area as shown in Figure 14.

The basic principles for proper puncture repair:

- Remove the tire from the wheel for inspection and repair;
- Prepare the injured area;
- Fill the injury with a suitable, vulcanizing material or rubber stem that must fill the injury and keep moisture out;
- Seal the innerliner with a patch to prevent loss of inflation and keep moisture out; and,
- Re-inspect the finished repair.

Refer to the USTMA wall chart for complete step by step procedures.

⚠ WARNING

Improperly repaired tires can fail while in service, such as by tread/belt separation, which can lead to an accident and serious personal injury or death.

Tires must always be properly repaired as described in the USTMA wall chart, "Puncture Repair Procedures for Passenger and Light Truck Tires."

Not all tires can be repaired. In addition to the USTMA puncture repair procedures, there may be additional limitations based on individual tire manufacturer repair policies. These may include the type of service such as speed rating, load index, run-flat technology and commercial application. When repairing a tire puncture:

- Never perform a tire repair on-the-wheel
- Never use only a plug (stem)
- Never use only a patch

⚠️ WARNING

Tire changing can be dangerous and should be done by trained personnel using proper tools and procedures. Always read and understand any manufacturer's warnings contained in owner's manuals, on the equipment, listed on websites and molded onto tire sidewalls.

Failure to comply with these procedures may result in faulty positioning of the tire and/or rim parts and cause the assembly to burst with explosive force sufficient to cause serious physical injury or death. Never mount or use damaged tires or rims.

For more information on tire mounting safety and procedures, refer to the USTMA wall chart "Demounting and Mounting Procedures for Passenger and Light Truck Tires."

Vehicle Original Equipment Temporary Tire Mobility Kits

A temporary tire mobility kit may be supplied by the vehicle manufacturer as an alternative to a spare or runflat tire in passenger car and light truck applications. The temporary tire mobility kit is normally comprised of a puncture sealant and a small air compressor or container of propellant.

Use of a temporary tire mobility kit:

- Is not considered a repair to the tire
- Only provides a temporary solution to promptly reach a service location for professional inspection and possible repair of the affected tire. Refer to tire manufacturer for specific guidelines regarding repairability and warranty.

End-users of temporary tire mobility kits supplied as original equipment in a passenger car or a light truck vehicle should always follow all instructions provided by the vehicle manufacturer, including limits on the amount of driving at reduced speeds allowed to safely reach a tire service location.

⚠️ WARNING

If a tire continually loses inflation pressure or has lost all or most of its inflation pressure, it must be removed from the wheel for a complete internal inspection to check for damage. Driving on damaged tires is dangerous. A damaged tire can suddenly fail, including by tread/belt separation, even at a later date, which can lead to an accident and serious personal injury or death.

Never perform a tire repair without removing the tire from the wheel assembly for an internal inspection. Do not perform an outside-in tire repair or an on-the-wheel repair.



The photos above are an example of a tire that was operated in an underinflated condition with a puncturing object that caused dangerous, non-repairable damage to the innerliner and body ply material. This type of damage would not have been visible from the outside of the tire.

Every tire must be removed from the wheel for an inspection and to assess repairability.

Aftermarket Sealants

The USTMA does not endorse aftermarket sealant products. Aerosol, liquid, gel or other substances injected into a tire through the valve are not considered proper repairs. Such products may be flammable and potentially explosive, may damage the tire, may void the tire manufacturer's warranty and may interfere with or damage tire pressure monitoring system sensors.

Consult the tire manufacturer's service recommendations and warranty policy. See "Tire Explosions and Flammable Substances" on p. 25.

Passenger and Light Truck Used Tires

This information applies to passenger and light truck tires, for use on light vehicles. As defined by 49 CFR Part 571.139, Federal Motor Vehicle Safety Standard (FMVSS) No. 139, light vehicles are motor vehicles with a gross vehicle weight rating (GVWR) of 10,000 lbs. or less. Tire sizes for light vehicles include all passenger car tires and light truck tire sizes (through Load Range E).

See USTMA Tire Information Service Bulletin, Vol. 45, "Passenger and Light Truck Used Tires".

Once tires are applied to a vehicle and put into service (this includes spare tires), they are considered "used." The purpose of this information is to address the potential risk associated with the installation of used tires that have uncertain or unknown history of use, maintenance or storage conditions. Such tires may have damage that could eventually lead to tire failure. This information pertains to used tires installed as replacement tires or as equipped on a used vehicle.

Before replacing tires, always refer to the vehicle manufacturer's replacement tire instructions in the owner's manual. Also refer to the vehicle and tire owner's manuals for additional important tire maintenance and safety information applicable to new and used tires.

Not all tire damage that can lead to tire failure is outwardly visible. For instance, improper repairs or damage to a tire innerliner can only be observed by inspecting the inside of the tire, demounted from the wheel. A qualified tire service professional should inspect the internal and external condition of the used tires prior to application. In the case of a used vehicle purchased by a consumer, the only way to determine the condition of its tires is to have them demounted by a tire service professional for the same type of inspection.

WARNING

Driving on damaged tires is dangerous. A damaged tire can suddenly fail leading to situations that may result in serious personal injury or death. Tires should be regularly inspected by a qualified tire service professional.

USTMA does not recommend the installation of used tires that exhibit any of the following characteristics:

- Any punctures or other penetrations, whether repaired or not. This is not meant to preclude the proper repair of a tire installed on a consumer's vehicle when the consumer is aware of the tire's history. (See USTMA wall chart "Puncture Repair Procedures for Passenger and Light Truck Tires")
- Any innerliner or bead damage.
- Indication of internal separation, such as bulges or local areas of irregular/fast treadwear indicating possible tread or belt separation.
- Indication of run-flat, under inflated and/or overloaded damage (e.g. innerliner abrasion, mid- to upper sidewall abrasion and stamping deterioration, delamination, or discoloration, excessive tread shoulder wear, etc.).
- Any damage or wear exposing the body material of the tire — cuts, cracks, bulges, scrapes, ozone cracking/ weather checking, impact damage, punctures, splits, snags, etc.
- Defaced or removed DOT tire identification number (TIN), which is located on the tire sidewall.
- Involved in a recall or a replacement program.
- Inadequate tread depth for continued service (i.e. nearly worn out). Tires with a tread depth of 2/32" or less at any point on the tire are worn out.
- Currently mounted on a rim that is bent, dented, cracked or otherwise damaged.
- Evidence of improper storage. See USTMA Tire Information Service Bulletin, Vol. 23, "Tire Storage Recommendations."
- Chemical, fire, excessive heat damage, or other environmental damage.
- Designated as a "scrap tire" or otherwise not intended for continued highway service.
- Evidence of prior use of tire repair sealant.
- Physically or chemically altered in any way (except by proper retreading) to change appearance or performance, including either sidewall and/or the tread (such as by regrooving or siping).
- Labeled on the sidewall as "Not For Highway Use", "NHS", "For Racing Purposes Only", "Agricultural Use Only", "SL" (service limited agricultural tire), or any other indication that the tire is barred from use on public thoroughfares.
- Any other condition which would be cause for permanent removal from service. For more about out-of-service tire conditions, refer to the Tire Industry Association's "Passenger and Light Truck Tire Conditions Manual." Visit www.tireindustry.org for details.

Spare Tire Maintenance

Spare tire (full-size and temporary spare) inflation pressure should be checked monthly and before any long trips. Use an accurate gauge. T-type temporary spare tires require 60 psi (420 kPa). When adjusting inflation pressure in T-type tires, do so in small amounts since the tire is smaller and the pressure level changes rapidly. Do not over inflate.

Inspect the spare tire/rim/wheel periodically (i.e. during tire rotation intervals) for any visible damage to the tire or corrosion on the wheel.

If the vehicle has a matching full-size spare tire, it is recommended that it be included in the tire rotation. Always check and adjust the inflation pressure of the full size spare when incorporating it into the rotation scheme.

T-type temporary spare tires should only be used with rims/wheels specifically intended for them. Rims/wheels intended for use with T-type tires should not be used with any other type of tires. A temporary spare tire and wheel assembly should never be used on a vehicle with which it is not compatible. Never use more than one temporary spare tire at a time.

Tire Storage Recommendations

Stored tires should be protected against environmental effects such as sunlight, high heat, ozone and other potentially damaging conditions. See USTMA Tire Information Service Bulletin Vol. 23, "Tire Storage Recommendations."

- Store tires where the area is clean, dry and well ventilated, but with a minimum of circulating air.
- Store tires in an area with temperate ambient conditions (mild temperatures, shaded or dark).
- Store tires raised off a storage area's floor surface to minimize exposure to moisture or damage.
- Avoid contact with petroleum-based products and/or other volatile solvents or substances.
- Store tires away from electric motors, battery chargers, generators, welding equipment or other ozone generating sources.

Indoor storage is recommended, however if tires must be stored outdoors:

- Store tires where they are raised off the ground (or on storage racks) and not in contact with heat absorbent surfaces.

- Protect tires with an opaque, waterproof covering with some type of vent openings to avoid creating a "heat box" or "steam bath" effect.

If tires are mounted on a stored vehicle:

Store the vehicle such that all weight is removed from the tires. If vehicle weight cannot be removed, unload the vehicle to minimize the weight. Maintain the recommended tire inflation pressure, including the spare. The surface where parked/stored should be firm, reasonably level, well drained and clean. Vehicle should be moved every three (3) months so the tire flex area is changed.

Returning tires from storage back to service:

Before placing stored tires back into service, a tire service professional should conduct a visual and tactile inspection to be sure each tire is clean, dry, free of foreign objects, and/or does not show signs of damage. See "Tire Inspection Guidelines" on p. 14. Once mounted on a rim/wheel, the tire (including the spare tire) should be inflated to the recommended inflation pressure. See "Proper Tire Inflation" on p. 11.

Cleaning Tires

Clean tires with soap and water and a soft bristle brush or a shop cloth. Treating tires with incompatible dressings or harsh cleaning agents will hasten oxidation and result in premature cracking. Never use petroleum-based products as tire dressings/cleaners. Use of a pressure washer or steam cleaner may be damaging to the tire.

Tire Sidewall Indentations

The condition, sometimes referred to as sidewall undulations, is a common characteristic of radial tire construction (see Figures 15 and 16 on p. 25). These indentations are more noticeable in tire sizes with higher aspect ratios and/or higher inflation pressures. Refer to USTMA Tire Information Service Bulletin Vol. 21, "Sidewall Indentations in Radial Tires."

In a radial tire the body ply cords run straight across the tire from bead to bead. The joining of the ply material creates a narrow overlap of ply cords in the radial direction at each junction. These overlapped ply cords slightly restrict the natural expansion of the sidewall when inflated. This results in an indentation. Since the belt plies reinforce the tread, only the sidewalls are indented.

Sidewall indentations are a cosmetic characteristic and will not affect the performance of the tire. If bulges, rather than indentations, appear on the sidewall or if there is any question concerning the sidewall appearance, the tire should be examined by a tire service professional.

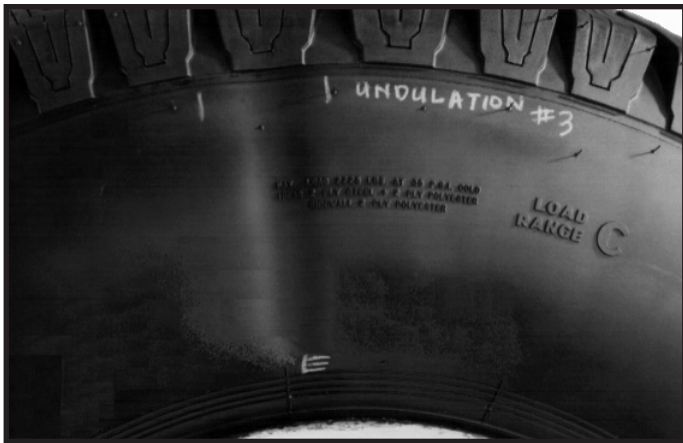

FIGURE 15: Sidewall Indentation

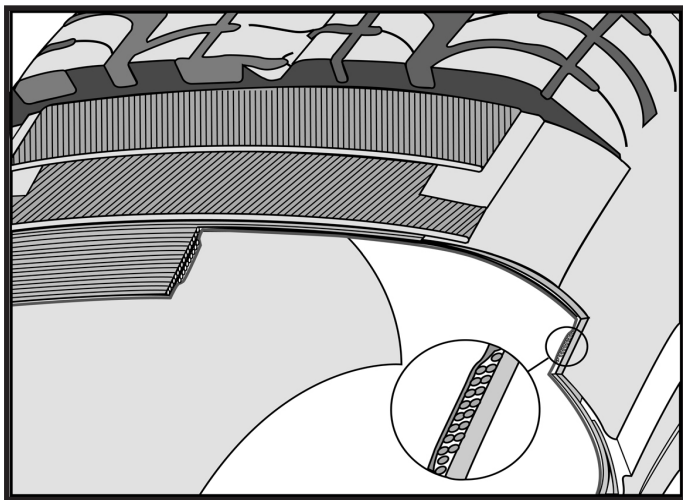

FIGURE 16: Radial Body Ply Overlap

Tire Explosions and Flammable Substances

Inflation pressure in a tire represents tremendous potential energy. If improperly treated, a tire can explode, suddenly releasing the stored-up energy which may result in serious injury or death. See USTMA Tire Information Service Bulletin, Vol. 3, "Tire Explosions Caused by Tire Spinning" and USTMA Tire Information Service Bulletin, Vol. 41, "Tire Bead Lubricants, Mounting Aids, Bead Sealers, OEM Mobility Kits, Tire Sealants, Balancing Substances and Flammable Substances". Causes of tire/wheel assembly explosions can include:

- Tire damaged during mounting/demounting
- Tire mounted on wrong size rim
- Improper mounting/demounting procedures
- Use of flammable solvents during tire mounting or to seat beads
- Exceeding tire maximum pressure limitation
- Flammable liquids or vapors introduced into the tire including sealants and aerosol inflators
- Welding, heating, or brazing an inflated tire/wheel assembly
- Improper tube fitment and pinching of the tube between the rim and tire during inflation
- Re-inflating a tire which has been run in an under inflated or over loaded condition
- Tire damaged in service or improperly repaired and re-inflated
- Exceeding rim maximum pressure limitation
- Brake over heating

Avoid flammable vapors inadvertently being pumped into a tire when the tire is inflated.

- Do not use alcohol, methanol, dry gas or any other flammable material in the compressor tank to prevent freezing or condensation.
- Do not store flammable solvents or rubber cements near the intake of the compressor.
- Do not clean the compressor intake screen/filter with flammable solvents such as gasoline.
- Do not use a battery charger near the compressor intake. This can result in hydrogen gas being drawn into the compressor.

Locate compressor indoors where freezing will not occur and in an area by itself away from operations such as tire repairing, battery charging, etc. Each day, open the bleed valve on the tank to expel moisture. Add a filter, trap, or dryer to the compressor to remove moisture.

Aftermarket Sealants/Inflators

Flammable propellants and/or liquids in aftermarket sealants or aerosol inflators may cause a tire to explode under certain circumstances. Never introduce a flammable substance into a tire. Tire service professionals should assume that any aftermarket product used to seal or inflate a tire is flammable. In addition to following proper demounting procedures (see p. 26), take the following precautions:

- Keep the tire away from heat, flame, sparks or other ignition sources
- Use tools with caution, particularly tire irons, reamers and hammers, to avoid causing sparks

- In a well-ventilated area and with the tire secured to a vehicle, tire mounting machine or other restraining device, remove the valve core and completely deflate the tire
- Re-inflate and deflate the tire a few times to further dissipate and expel potentially flammable vapor

⚠ WARNING

Never, under any circumstance, introduce a flammable substance into a tire.

Igniting this substance in an effort to facilitate seating the beads is extremely unsafe. This may result in an explosion of the tire with force sufficient to cause serious personal injury or death.

This practice may also result in undetected damage to the tire or rim that could result in failure of the tire in service.

⚠ WARNING

Serious injury or death may result from an explosion of the tire and rim/wheel assembly due to heating the rim/wheel. Never rework, weld, braze or heat a wheel or rim.

Tire Spinning

The centrifugal forces created by a rapidly spinning tire can cause an explosion by literally tearing the tire apart. These forces act on the complete tire structure, and can be of such magnitude as to break the beads in addition to rupturing the tire. Some vehicles are able to bring a tire to its centrifugal force failing point in just 3 to 5 seconds. Refer to the USTMA Tire Information Service Bulletin, Vol. 3, "Tire Explosions Caused by Tire Spinning."

- When stuck on ice, snow, mud, or wet grass, the vehicle should be rocked gently (alternately using forward and reverse gears) with the least amount of wheel spinning. Repeatedly shift the gear lever from drive to reverse on automatic transmissions or reverse to second on manual transmissions, while applying gentle pressure to the accelerator. Vehicles with ABS or traction control systems need to follow the instructions in their owner's manual.

- Never exceed 35 mph (56 km/h) indicated speed on the speedometer
- Never allow anyone to stand near a spinning tire

⚠ WARNING

Excessive speed in a free-spinning tire can cause the tire to explode from extreme centrifugal force. The energy released by such an explosion is sufficient to cause serious physical injury or death.

Never spin a tire above a speedometer reading of 35 mph (56 km/h). Never stand near a spinning tire.



Mounting and Demounting Procedures

For detailed instructions on mounting passenger and light truck tires, refer to the USTMA wall chart "Demounting and Mounting Procedures for Passenger and Light Truck Tires." Read and understand the procedures and safety warnings before proceeding.

For additional information on tire mounting, refer to the following:

- USTMA Tire Information Service Bulletin, Vol. 43, "Avoid Tire Bead Damage on Tire Mounting Machines that Secure the Rim From Underneath"
- USTMA Tire Information Service Bulletin, Vol. 46, "Proper Tire Mounting of Low Aspect Ratio, High Performance Passenger and Light Truck Tires"
- See p. 25 "Tire Explosions and Flammable Substances"

NOTE

Only mount tires on approved rim widths.

Tire Bead Lubricants Used to Mount Tires - Use commercially available lubricants made for bead seating to seat tire beads. Also, vegetable oil and animal soap solutions may be used. If a lubricant is water-based, it should contain a rust inhibitor. Care should be exercised to avoid excessive application of lubricant to minimize moisture in the pressure chamber. Do not allow any lubricant to run between the tube and casing in tube-type tires or on the inside surface of tubeless tires. When dry, the lubricant should not remain slippery.

Tire Mounting Aids and Bead Sealers - Some mounting aids (such as rubber "O" rings or "donuts") can become trapped between the tire bead and rim during mounting. This prevents the bead from properly seating on the rim, which can lead to failure.

Bead sealers may also impede bead seating if allowed to dry on beads and rim contact surfaces before mounting.

Valve Maintenance - Always remove and replace snap-in valves when replacing tires. Never reuse snap-in valves. Only use valves that are compatible with the rim being serviced. See USTMA Tire Information Service Bulletin, Vol. 40, "Tubeless Type Valves for Passenger and Light Truck Tires Including Tubeless Snap-In Tire Valve Installation Procedure."

Always cover the valve stem with a sealing cap. This helps prevent moisture, dirt and other contaminants from entering the valve core as well as providing an additional seal. Any time a tire is demounted for any reason, including repairs, also inspect the valve stem for damage (crack, tears, etc.) to determine if the valve stem should be replaced. For inflation pressures above 65 psi (450 kPa), a high-pressure valve must be used. The proper valve must be used for the particular tire/wheel application.

Tire/wheel assemblies that are equipped with a tire pressure monitoring system (TPMS) may have a sensor that is attached to or is part of the valve assembly. When new tires are installed it is recommended to also replace all components that are included in the TPMS valve replacement kit. In addition, whenever the sensor is disassembled for any reason, install a new TPMS replacement kit. Always replace any damaged sensor.

NOTE

If the TPMS valve is replaced by a conventional valve, the TPMS will not function.

WARNING

Tire changing can be dangerous and should be done by trained personnel using proper tools and procedures. Always read and understand any manufacturer's warnings contained in owner's manuals, on the equipment, listed on websites and molded onto tire sidewalls.

Failure to comply with these procedures may result in faulty positioning of the tire and/or rim parts and cause the assembly to burst with explosive force sufficient to cause serious physical injury or death. Never mount or use damaged tires or rims.

For more information on tire mounting safety and procedures, refer to the USTMA wall chart "Demounting and Mounting Procedures for Passenger and Light Truck Tires."

WARNING

NEVER INFLATE BEYOND 40 PSI TO SEAT BEADS.
NEVER STAND, LEAN, OR REACH OVER THE ASSEMBLY
DURING INFLATION.

Inspect both sides of the tire to be sure that the beads are evenly seated. If tire is mounted on a machine that does not have a positive lock-down device to hold the wheel, inflation should be done in a safety cage or other restraining device. If both beads are not properly seated when pressure reaches 40 psi, completely deflate the assembly, reposition the tire and/or tube on the rim, relubricate, and reinflate.

Inflating beyond 40 psi inflation pressure when trying to seat the beads is a dangerous practice that may break a tire bead (or even the rim) with explosive force, possibly resulting in serious injury or death. After the beads are fully seated, pressure may be increased above 40 psi to operating pressures, as shown on the vehicle placard but not to exceed the maximum molded on the tire sidewall.

⚠️ WARNING

There is a danger of serious injury or death if a tire of one bead diameter is installed on a rim or wheel of a different rim diameter. Always replace a tire with another tire of exactly the same bead diameter as the diameter of the rim on which it will be mounted.

For example: a 16" tire goes on a 16" rim. Never mount a 16" tire on a 16.5" rim. A 16.5" tire goes on a 16.5" rim. Never mount a 16.5" tire on a 16" rim. While it is possible to pass a 16" diameter tire over the lip or flange of a 16.5" size diameter rim, it cannot be inflated enough to position itself against the rim flange. If an attempt is made to seat the tire bead by inflating, the tire bead will break with explosive force and could cause serious injury or death.

Rims of different diameters and tapers cannot be interchanged. The following diagram illustrates the difference between rims of two different tapers and diameters:

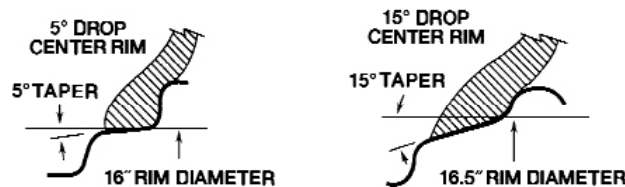

The following diagram shows how beads of a 16" tire will not seat on a 16.5" rim. The beads cannot be forced out against the rim flanges by using more inflation pressure because this will break the beads and the tire will explode with force sufficient to cause serious injury or death.



⚠️ WARNING

Never, under any circumstance, introduce a flammable substance into a tire.

Igniting this substance in an effort to facilitate seating the beads is extremely unsafe. This may result in an explosion of the tire with force sufficient to cause serious personal injury or death.

This practice may also result in undetected damage to the tire or rim that could result in failure of the tire in service.

⚠️ WARNING

Silicone, petroleum, or solvent-based lubricants must not be used. These substances may:

- cause the tire to slip on the rim.
- have a harmful effect on the tire, tube, flap and/or rim.
- create explosive mixtures of air and vapors in the tire which may result in serious injury or death.

⚠ WARNING

Serious injury or death may result from explosion of tire and rim/wheel assembly due to improper mounting.

- Never exceed 40 psi (inflation pressure) when seating beads.
- Always use a safety cage or other restraining device with a clip-on extension hose.
- Only specially trained persons should mount tires.

Tire/Wheel Balancing and Installation

Tire/wheel balance is important for proper tire tread wear. Out-of-balance conditions may reduce tire mileage significantly and can be the source of vehicle vibration and bounce. Maintaining tire/wheel balance over the service life of the tire helps to maximize the tire's performance.

There are two types of out-of-balance conditions for tire/wheel assemblies that cause vibration at highway speeds. See Figure 17. Static balance, also known as single plane balance, may result in vibration due to vertical (up and down) movement. It can be corrected using a bubble or spin balancer. Uneven distribution of weight across another axis of the wheel causes vibration due to rotational movement (wobble or shimmy). It can only be corrected using a dynamic spin balancer which also can correct static imbalance.

Dynamic Computer-Controlled Balance Machine Set-up and Usage

Tire/wheel service centers using dynamic spin balancing machines establish the optimal balance of the tire/wheel assembly by correcting both types of imbalance. Only trained tire service professionals should perform tire balancing. Balancing equipment should be properly set up and calibrated with particular attention to the wheel assembly alignment (e.g. hub-centric or lug-centric wheels). With larger passenger and light truck tires, flange plate adaptors may be required to obtain accurate tire/wheel balance.

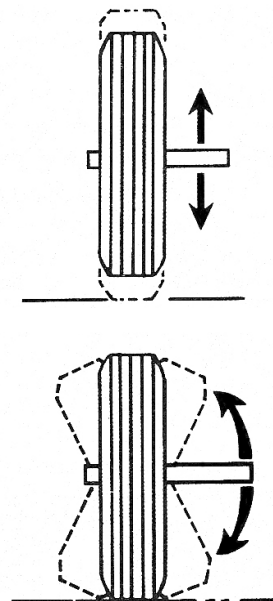

FIGURE 17: Two Types of Tire/Wheel Imbalance

Tire/Wheel Assembly Installation

Consult the vehicle owner's manual for recommendations on tire/wheel assembly installation. Identify lug torque specifications for proper installation. It is recommended that lug nuts and bolts be tightened to exact torque specifications with a torque wrench. Improper torque, either too loose or too tight, may cause loss of lug nuts, breaking of the stud(s), damage to the tire/wheel assembly, or detachment of the tire/wheel assembly from the axle. Never use air tools to install custom wheels. Always use a torque wrench for final tightening and follow accepted tightening (torquing) procedures.

⚠ WARNING

TIRE SEALANTS AND BALANCING SUBSTANCES

Solvent-based liquids must not be used due to the possibility of creating explosive mixtures of vapors in the tire, which may result in serious injury or death.

Ride Comfort Optimization Procedures and Diagnostics

Tire Manufacturer Match-Mount Markings

New tires are often marked by the manufacturer to indicate the location (known as the “high point”) that should be matched to a particular location on a wheel. The marking is generally a colored-spot on the sidewall. It should be matched to a location on the wheel (known as the “low point”) often at or near the valve.

Consult with the tire manufacturer for the meaning of match-mount markings and recommendations for match-mounting to wheels.

Match-Mount Balancing Machines

Consumer expectations and increased sensitivity of vehicles have resulted in additional procedures to produce a smooth, quiet ride. Balancing machines with ride optimization features may be used to prevent or resolve many ride/vibration complaints.

These machines have the capability of evaluating the tire/wheel assembly and the wheel alone following prescribed match-mounting procedures. Match-mounting techniques can minimize potential vibration. Wheel measurements can highlight possible wheel irregularities. Use of these machines can assist with diagnosis of tire/wheel-related vibration complaints.

However, match-mounting balancing machines are not laboratory or factory-grade tire uniformity measurement machines and should never be used to screen new tires for uniformity. Consult the tire manufacturer for their policy regarding tires evaluated using match-mount balancing machines.

Manual Ride Optimization Procedure (Manual Run-Out Method)

Follow these steps to manually diagnose a tire/wheel assembly suspected of causing vibration:

1. Test drive the vehicle to determine where the vibration is originating.
2. Place the suspect tire and wheel assembly on the balance machine and check its balance. Correct if necessary and test drive the vehicle again.
3. If the balance is acceptable and the vibration is still present, next check the tire and rim for run-out.
 - a. Place the suspect tire and wheel assembly on the balance machine.

- b. Place a run-out gauge or dial indicator in the center of the tire tread. Set the gauge at zero.
- c. Slowly rotate the tire and rim assembly 360 degrees. While rotating, observe the gauge and determine the location of greatest run-out. Mark that location on both the tire tread and wheel.
- d. Deflate the tire and rotate it, until the mark on the tire is exactly opposite from the mark on the wheel (180 degrees).
- e. Reinflate the tire. Recheck the tire/wheel assembly run-out by slowly rotating the assembly 360 degrees.
- f. If the run-out has been reduced, rebalance the tire wheel assembly, install on the vehicle and perform a test drive. If the run-out has not been reduced, find the peak run-out. If the peak run-out is located near the area where the rim was originally marked, the rim may be the cause. Consult the rim manufacturer. If the peak run-out is located near the area where the tire was marked, the tire may be the cause of vibration. Consult the tire manufacturer.
- g. To confirm the run-out of the rim, it may be necessary to demount the tire and check the rim with a run-out gauge indicator against each bead

NOTE

To confirm the run-out of the rim, it may be necessary to demount the tire and check the rim with a run-out gauge indicator against each bead seat ledge.

“Zipper Ruptures” in Steel Cord Radial Medium and Light Truck Tires

The following applies to tires with steel cord casings.

Any inflated tire suspected of having been operated under inflated and/or over loaded must be approached with caution. A tire service professional must remove the valve core and completely deflate the tire before removing the tire/wheel/rim assembly from the vehicle. Clearly mark the tire in an appropriate manner indicating it has been run under inflated and is a potential for a zipper rupture. See Figure 18 and 19 on p. 31. Do not return the tire to service without following proper procedures, including an inspection by a tire service professional. See USTMA Tire Information Service Bulletin, Vol. 33, “Inspection Procedures to Identify Potential Sidewall ‘Zipper Ruptures’ in Steel Cord Radial Truck, Bus, and Light Truck Tires.”

⚠️ WARNING

Any steel cord radial tire suspected of operating under inflated and/or over loaded must be approached with caution. Permanent damage due to operating a tire under inflated and/or over loaded cannot always be detected. Any tire known or suspected of being operated at 80 percent or less of normal operating inflation pressure and/or over loaded could possibly have permanent sidewall structural damage (steel cord fatigue).

Ply cords weakened by under inflation and/or over loading may break one after another, until a rupture occurs in the upper sidewall with accompanying instantaneous pressure loss and explosive force. This can result in serious injury or death.

See USTMA Tire Information Service Bulletin, Vol. 33, "Inspection Procedures to Identify Potential Sidewall 'Zipper Ruptures' in Steel Cord Radial Truck, Bus, and Light Truck Tires."

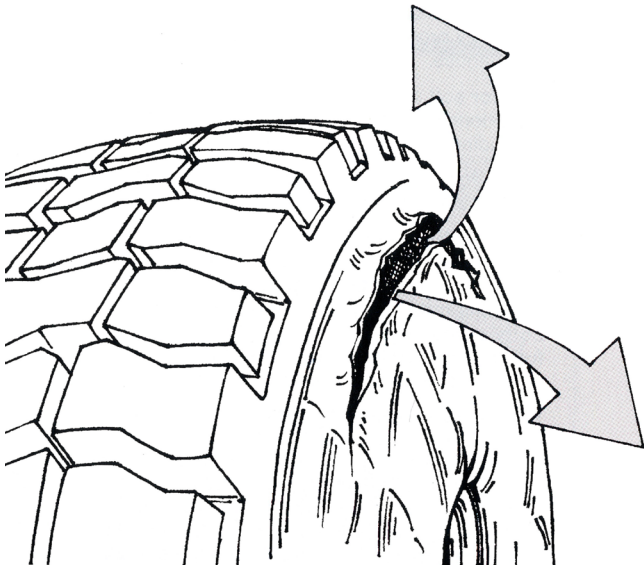

A grazing light or other indirect light source used during inspection can reveal shadows of any sidewall irregularities that are signs of a potential zipper rupture.



FIGURE 18: Zipper Rupture Example

An example of an actual zipper rupture. Note the characteristic "zipper-like" seam along the sidewall where the rupture occurred.



FIGURE 19: Actual Zipper Rupture Example

Tire Retreading

While retreading tires is predominantly a practice used for commercial truck and bus tires, there are some companies that retread light vehicle tires. Note that it takes special equipment and expertise to retread passenger car and light truck tires.

Don't sell, use or retread tires whose original DOT marking/serial number has been removed, obliterated or branded over.

Overview

The purpose of this chapter is to provide tire industry recommended guidelines and important safety information when replacing tires for light vehicles as defined by 49 CFR Part 571.139, Federal Motor Vehicle Safety Standard (FMVSS 139), light vehicles are motor vehicles with a gross vehicle weight rating (GVWR) of 10,000 lbs. or less. Tire sizes for light vehicles include all passenger car tires and light truck tire sizes (through Load Range E). While this chapter is intended to outline general guidelines and considerations for tire replacement, it is not all-inclusive. Questions pertaining to specific products and/or vehicle fitments should be addressed to the vehicle manufacturer, tire manufacturer, or tire dealer. Because tire technology continually evolves, visit the USTMA web site at www.USTires.org for current information.

NOTE

Before replacing tires, ALWAYS refer to and follow the vehicle manufacturer's tire replacement recommendations and restrictions.

The Right Tire for the Vehicle

When tires need to be replaced, do not guess what tire is right for the vehicle. For the answer, refer to the vehicle tire placard and/or certification label, usually located on the vehicle door edge, door post, glove box or fuel door (see Figure 20 and 21.) Also, check the vehicle owner's manual for any additional tire replacement recommendations. The vehicle tire placard identifies the size of the tires, including the spare, that were installed on the vehicle as original equipment (OE). The placard also specifies the recommended cold inflation pressures for the tires on the front/rear axles and for the spare. The placard may include seating capacity and combined weight of occupants and cargo. If the vehicle does not have a vehicle tire placard or certification label, consult the vehicle owner's manual, vehicle manufacturer, or tire manufacturer. A tire dealer should also be familiar with these requirements and is an excellent resource.

In addition, tires have very useful information molded into the sidewall including the tire brand, model, size, speed rating, maximum load, maximum inflation, and safety warning(s). See Chapter 1.

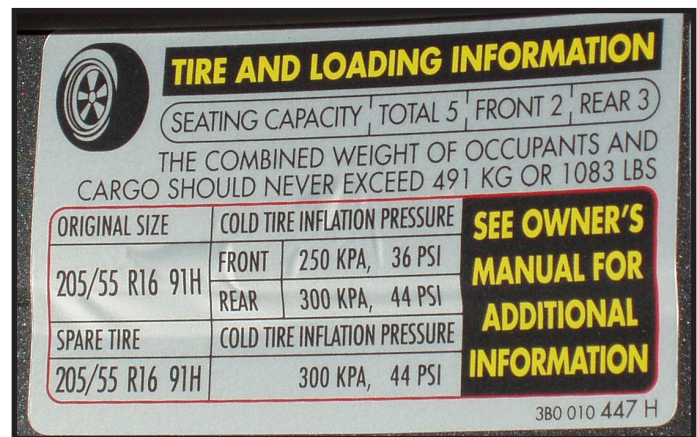

FIGURE 20: Example of a Vehicle Tire Placard

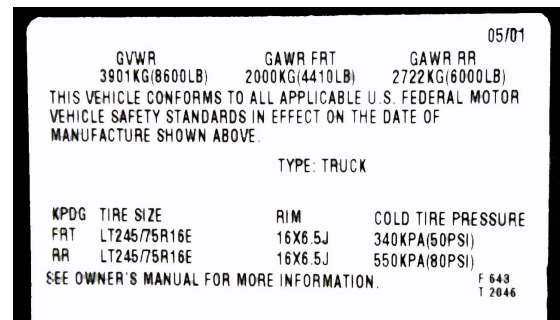

FIGURE 21: Example of a Vehicle Certification Label

Tire Size, Inflation and Load

Tire Replacements

Replacement tires should be the same as the OE size designation, or approved options, as recommended by the vehicle or tire manufacturer. Never choose a replacement tire of a smaller size or with less load-carrying capacity than the OE tire size at the specified vehicle tire placard pressure. Under certain circumstances, a vehicle manufacturer may recommend or permit a specific substitute tire size, inflation pressure, maximum speed, maximum load, etc. It is recommended that all four tires be of the same size, speed rating, and construction (radial, non-radial). In some cases, the vehicle manufacturer may specifically advise against the application of replacement tires that are not the original size. In other cases, the vehicle manufacturer may require different sized tires for either the front or rear axles. (Also see "Tire Mixing" on p. 35, and "Important Considerations" on p. 39.) Always check and follow the recommendations in the vehicle owner's manual.

NOTE

ALWAYS check the vehicle manufacturer's recommendations for the OE tire size, load capacity, inflation pressure, and speed rating information before replacing a tire with a different size and construction. It is not always possible to select the same tire size for a replacement tire. NEVER choose a tire of a smaller size or with less load-carrying capacity than the OE tire size at the specified vehicle tire placard pressure.

Replacement tires must have:

- Inflation pressure capability equal to or greater than the operating inflation pressure specified on the vehicle tire placard.
 - When determining the proper tire inflation pressure settings for substitute tires, never exceed the maximum pressure listed on the sidewall of the tires.
 - Carefully note any differences between recommendations for front and rear axle positions regarding the tire size and/or inflation pressure.
- Load-carrying capacity must be equal to or greater than the load-carrying capacity of the OE tire size at the specified vehicle tire placard pressure.
- Speed rating (such as S, T, H, V, W and Y) must be equal to or greater than what is specified by the vehicle manufacturer if the speed capability of the vehicle is to be maintained. (Also see "Tire Mixing" on p. 35, and "Important Considerations" on p. 39.)

NOTE

Be sure to maintain any difference in inflation pressures for front and rear tires as indicated on the vehicle's tire placard.

Tire Size Designation Differences Between Passenger and Light Truck Tires

Passenger Tires: P-Metric, Metric

Light Truck Tires: LT-Metric, LT High Flotation, C-Type
European Commercial Metric, LT Numeric

These groups of tires have differences in their load and inflation characteristics, including some differences in their load capacity if they are applied to a passenger car versus a light truck. Vehicle handling may be affected when passenger tires are replaced with LT tires. Therefore, it is necessary

to carefully consider these differences when considering a replacement tire that is not the same as the OE size.

For example, there are a variety of tire types that may be applied to certain vans; refer to USTMA Tire Information Service Bulletin, Vol. 49 "Tires on Certain Globalized ("Euro") Vans" for detailed information.

Light Truck Tire Replacement

In addition to the considerations already stated, also be sure to take into account the following items relative to light truck tire replacement.

- Tires should only be mounted on approved rim widths (see "Tire Rim/Wheel Selection" on p. 37). If changing tire size, the rim/wheel must have adequate load and inflation pressure capability. For rims/wheels not so identified or for service conditions exceeding the rated capacities, consult the rim/wheel manufacturer to determine the rim/wheel capabilities.
- Body and chassis clearance must be checked on the vehicle's front and rear axles (see "Tire Diameter and Tire/Vehicle Clearance" on p. 37).
- Proper spacing between duals (minimum dual spacing) is necessary for optimum tire performance. Consult tire or vehicle manufacturers' literature for recommendations. If chains are used, assure adequate clearance between loaded tires to avoid damage from chains. Allowable outside diameter differences between a tire and its dual mate is 1/4" for light truck tires.
- For tube type tires, be sure to use approved tubes/flaps/valves for the replacement tire. When used in radial tires, tubes and flaps designated for radial tire use are required.

Replacing OE Passenger Tires with Light Truck Tires

Some vehicles, such as sport utility vehicles, vans, and pick-up trucks, may have passenger tires installed as original equipment. As previously stated, it is preferred that replacement tires should be the same OE size designation, or approved options, as recommended by the vehicle or tire manufacturer. However, in some cases, the OE passenger tires on these types of vehicles can be replaced with light truck tires, including C-Type European Commercial tires.

NOTE

When replacing OE passenger tires with light truck tires, check with the vehicle manufacturer to be sure the rim/wheel is appropriate for the required higher inflation pressures. Check rim widths and rim load/inflation capacity; check body and chassis clearance. Purchase of new rims/wheels may be required.

Light truck tires for light vehicles, which are vehicles with a Gross Vehicle Weight Rating ("GVWR") of 10,000 lbs. or less, typically include load ranges B, C, D and E.

Replacing passenger car tires with light truck tires will require a significant inflation pressure adjustment in order to carry the same load as the original equipment size. Passenger tire load-carrying capacity must be reduced by dividing by 1.10 for light truck applications. For example: P265/70R17

WARNING

There is a danger of serious injury or death if a tire of one bead diameter is installed on a rim or wheel of a different rim diameter.

ALWAYS replace a tire with another tire of exactly the same bead diameter as the diameter of the rim on which it will be mounted.

For example: a 16" tire goes on a 16" rim. NEVER mount a 16" tire on a 16.5" rim. A 16.5" tire ONLY goes on a 16.5" rim. NEVER mount a 16.5" tire on a 16" rim.

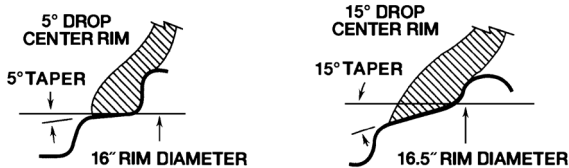

While it is possible to pass a 16" diameter tire over the lip or flange of a 16.5" size diameter rim, it CANNOT be inflated enough to position itself against the rim flange. If an attempt is made to seat the tire bead by inflating, the tire will break with explosive force and could cause serious injury or death.

Rims of different diameters and tapers CANNOT be interchanged. The following diagram illustrates the difference between rims of two different tapers and diameters.

The following diagram shows how beads of a 16" tire will not seat on a 16.5" rim. The beads CANNOT be forced out against the rim flanges by using more air pressure because this will break the beads and the tire will explode with force sufficient to cause serious injury or death.



which has a maximum load capacity for passenger vehicle application = 2535 lbs. For a light truck application, using the formula, the maximum load capacity would be $2535 / 1.10 = 2305$ lbs. In addition to the important considerations listed above, be sure to consult with vehicle manufacturer, tire manufacturer, and/or a professional tire dealer for the appropriate replacement size, adjusted inflation pressure, and load rating for the vehicle. See "Important Considerations, Inflation Pressure: OE vs. Replacement" on p. 39.

NOTE

Unless otherwise specified by the vehicle manufacturer, it is not recommended to replace OE LT-metric, LT High Flotation, or C-Type European Commercial tires with P-metric (e.g. P205/60R15) or European metric tires (e.g. 205/60R15).

Self-Supporting Runflat Tire Replacement

Runflat tires have specific servicing requirements, such as product-specific puncture repair or demounting/mounting procedures, which vary by vehicle and tire manufacturers. Consult with the manufacturers for details. A functioning tire pressure monitoring system (TPMS) must be used with runflat tires. Refer to USTMA Tire Information Service Bulletin, Vol. 47, "General Information on Self-Supporting Runflat Tires."

Four Tire Runflat Replacement

When replacing tires normally (i.e. wear out), it is recommended and preferred that all four runflat tires are replaced at the same time with four runflat tires in order to maintain runflat tires' mobility, TPMS capability, and vehicle handling, stability and performance. Check owner's manual for specific recommendations. It is important to ensure that the TPMS on the vehicle functions with the replacement runflat tires.

Emergency, Temporary Single Conventional Tire Replacement

Depending on the circumstances, some runflat tires must be replaced after they have experienced low- or zero-inflation pressure. Never mix runflat tires with conventional tires (tires that do not have runflat technology) unless in an emergency situation on a limited, temporary basis. The conventional tire should be replaced with a runflat tire as soon as possible. It is not recommended to mix incompatible runflat technologies/products. If a conventional tire is used on a temporary basis, it

is important to note that vehicle handling characteristics may be affected. Also it is recommended that the conventional replacement tire is of the same size, inflation pressure, load-carrying capacity and speed rating noted on the vehicle tire placard.

Runflat Replacement with Four Conventional Tires

It is recommended and preferred to replace runflat tires with runflat tires; however, a consumer may wish to replace the OE runflat tires with non-runflat, conventional tires. Consult with the vehicle and tire manufacturers before replacing runflat tires with conventional tires to identify any vehicle operation restrictions. If the conventional tire option is chosen, then application restrictions apply, including but not limited to the following:

- Loss of runflat capability
- Emergency mobility is negated (to maintain mobility, the consumer will need to acquire additional equipment, such as a spare tire, new rim/wheel assembly, hand jack, etc.)
- Vehicle TPMS visual displays, audible alarms, and logic designed for runflat operation may be affected
- Vehicle handling, stability and performance can be affected
- Vehicle owner's manual reference regarding OE runflat tire fitment may no longer apply

As standard practice, any replacement tires should be of the same size, inflation pressure, load-carrying capacity and speed rating as noted on the vehicle tire placard.

Replacing Conventional Tires with Runflat Tires

Depending on the specific tire, vehicle, wheel, TPMS, and other factors, runflat tires may be acceptable replacements for conventional tires. However, a vehicle or tire manufacturer may advise against the application of certain runflat tires to certain vehicles that were not originally equipped with runflat tires. Therefore, the vehicle and tire manufacturers must be consulted on their tire replacement recommendations for specific vehicles and runflat tires.

If conventional tires are to be replaced by runflat tires, follow the same tire replacement recommendations established for conventional tires that include selecting the proper tire size(s) and meeting inflation pressure capacity, load-carrying capacity and speed rating requirements. Refer to the vehicle and tire manufacturers' tire replacement recommendations and the vehicle tire placard, certification label, and/or owner's manual.

In addition, note the following recommendations:

- The vehicle must have an operational TPMS. If not originally equipped with a TPMS, a system must be retro-fit to the vehicle.
- Do not mix tires with incompatible runflat technologies on a vehicle (for example, all tires should be the same type of self-supporting runflat).
- The wheels must be the recommended size/rim contour, such as extended hump (example: EH2 and EH2+) marked rims and must be compatible with the runflat tires and any TPMS sensors.
- The Inflation pressure recommendations for runflat tires are the same as those for conventional tires that have the same size code, load index and speed rating.

Never mix runflat tires with conventional tires unless in an emergency situation on a limited, temporary basis. See Emergency, Temporary Single Conventional Tire Replacement above.

Tire Mixing

It is recommended that all four tires be of the same size, load index, speed rating, and construction (radial, non radial). In some cases the vehicle manufacturer may require different sized tires for either the front or rear axles. NEVER mix P-Metric or Metric passenger tires with light truck tires, including C-Type European Commercial tires, on the same vehicle.

It is recommended to match tire size designations in pairs on an axle, except for temporary use of a spare tire.

If two radial tires and two non-radial tires are used on a vehicle, put radials on the rear axle. If radial and non-radial tires are used on a vehicle equipped with dual rear tires, the radial tires may be used on either axle.

Speed Rated Tire

If the vehicle tire placard and/or owner's manual specifies speed rated tires, the replacement tires must have the same or higher speed rating to maintain vehicle speed capability. Tire speed ratings do not imply that vehicles can be safely driven at the maximum speed for which the tire is rated, particularly under adverse road and weather conditions, or if the vehicle has unusual characteristics. Never operate a vehicle in an unsafe or unlawful manner.

If replacement tires have lower speed capability than specified by the vehicle manufacturer, the vehicle's speed

must be restricted to that of the replacement tire. Also, vehicle handling could be affected. Consult vehicle manufacturer or tire manufacturer for recommendations.

Four-wheel Drive (4WD) and All-wheel Drive (AWD) Vehicles

If no instructions for tire mixing appear in the vehicle owner's manual, follow these guidelines:

- Do not mix tire sizes. All four tires must be marked with the same tire size, unless otherwise specified by the vehicle manufacturer. This also applies to winter/snow tires.
- Do not mix radial and non-radial tires. All four must be either radial or non-radial.
- Do not mix tread pattern types such as all-terrain and all-season.

Winter/Snow Tires

It is always preferable to apply winter/snow tires to all wheel positions, including duals, to maintain vehicle mobility and control. Refer to USTMA Tire Information Service Bulletin, Vol. 42, "Application of Winter/Snow Tires and Studded Winter/Snow Tires."

- If winter/snow tires are applied to the front axle of a vehicle, winter/snow tires must also be installed on the rear axle. Do not apply winter/snow tires only to the front axle. This applies to all passenger and light truck vehicles including front-wheel-drive, 4WD, and AWD vehicles.
- If winter/snow tires are installed on the rear axle of any vehicle, it is recommended (but not required) that they also be installed on the front axle.

Studded Winter/Snow Tires

Studded winter/snow tires have higher traction qualities under most winter weather conditions.

- If studded winter/snow tires are installed on the front axle of any vehicle, studded winter/snow tires must also be installed on the rear axle. Do not apply studded winter/snow tires only to the front axle.
- If studded winter/snow tires are installed on the rear axle of any vehicle, it is recommended that they should also be installed on the front axle. Only if studded winter/snow tires are installed on all wheel positions of a vehicle will optimum handling characteristics be achieved.

Some states prohibit the use of studded tires and many states have seasonal limitations on their use. Before installing, check with state and local regulations.

WARNING

Installing winter/snow tires (studded or unstudded) only on the front axle may cause the vehicle to experience adverse handling characteristics. This may result in an accident, which could cause serious injury or death.

Replacing Less Than Four Tires

When replacing tires on a vehicle, it is recommended and preferred that all four tires be replaced at the same time for continued optimal vehicle performance. However, for those cases where this is not feasible, below are some general guidelines to consider when replacing less than four tires for a light vehicle, whether it is one or two tires. (Also see "Tire Mixing" on p. 35.) If the vehicle manufacturer has alternate recommendations, always follow their recommendations.

NOTE

In some cases, the vehicle manufacturer may specifically advise against replacing less than all four tires. Always check and follow the recommendations in the vehicle owner's manual. For 4WD and AWD vehicles, even small differences in outside diameter may cause drive-train damage or mechanical malfunction.

Replacing Two (2) Tires

When a pair of replacement tires is selected in the same size and construction as those on the vehicle, the two new tires should be installed on the rear axle. Generally, new tires with deeper tread will provide better grip and evacuate water more effectively, which is important as a driver approaches hydroplaning situations. Placing greater traction on the rear axle on wet surfaces is necessary to prevent a possible oversteer condition and loss of vehicle stability.

Replacing One (1) Tire

Replacing a single tire on a vehicle can have an adverse effect on suspension systems, gear ratios, transmission, and tire treadwear. If single tire replacement is unavoidable, it is recommended that the single new tire be paired with the tire that has the deepest tread and both be placed on the rear axle. Placing greater traction on the rear axle on wet surfaces is necessary to prevent a possible oversteer condition and loss of vehicle stability.

Tire Rim/Wheel Selection

Tires should only be mounted on approved rim widths (for more information, refer to tire manufacturer product literature for rim width specifications). See Figure 22 for an example of rim width measurement.

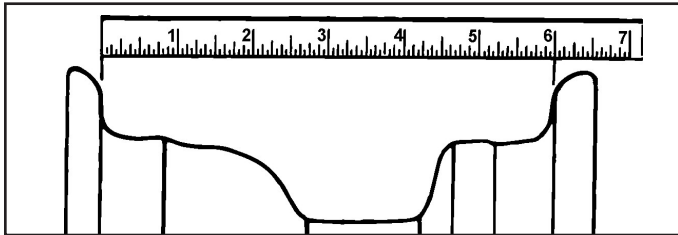

FIGURE 22: Example Rim Width (6.0-Inch)

- Always check to be certain that the diameter designation for both tire and rim are the same. For example, a P235/75R16 tire must be mounted on a 16-inch rim (see the rim WARNING on p. 34).

NOTE

Always use approved tire/rim combinations for rim diameter, width and contour. Refer to tire manufacturer product literature for approved rim specifications.

- If replacement tires or rims/wheels are of a different size from the OE, be sure that the outside circumference of all four tires is within the accepted tolerance of the vehicle manufacturer.
- Some rims/wheels may not allow correct bead seating unless the OE tire is used. Consult vehicle manufacturer.
- Never exceed the maximum pressure and/or load capacity of the rim/wheel.

WARNING

High pressure "T" type temporary spare tires should not be used with any other rims/wheels, nor should standard tires, snow tires, wheel covers, or trim rings be used with the high pressure "T" type temporary spare rim/wheel. A "T" type temporary spare tire and wheel assembly should never be used on a vehicle with which it is not compatible, nor should more than one such tire ever be placed on any vehicle at a given time. Standard tires or snow tires should NOT be mounted on a high pressure compact spare wheel.

Mismatch of the tire and/or rim parts may cause the assembly to burst with explosive force, sufficient to cause serious physical injury or death.

Tire Diameter and Tire/Vehicle Clearance

Acceptable load index, load capacity, and/or overall diameter do not imply acceptable vehicle clearance. Body and chassis clearance must be checked on the vehicle's front and rear axles. If replacement tires or rims are of a different size from the original equipment, all four (4) wheel positions must be checked for proper clearance in the fender well, around brake components, shock towers, other suspension components, etc. These wheel positions must be checked for full suspension jounce and rebound. Steering tires must be checked in full left and right turns. Also, check to be sure that the outside circumference of all four tires is within the accepted tolerance of the vehicle manufacturer.

Differences in overall diameter may affect vehicle handling and stability as well as the following: speedometer, odometer, ABS, tire pressure monitoring system, 4WD / AWD / traction control, and other electronic systems. To maintain accuracy, resetting or recalibration of these systems may be necessary. Compare the nominal dimensions on the vehicle tire placard and candidate replacement sizes. Check the vehicle manufacturer's recommendations.

Plus Sizing

Plus sizing for light vehicles in the after-market is primarily based on the following tire/wheel characteristics:

1. Maintain overall tire diameter of the OE tires
2. Increase the tire section width (contact patch/footprint becomes shorter and wider)
3. Decrease the series profile (aspect ratio or section height)
4. Increase the rim/wheel diameter

NOTE

Before replacing tires, always refer to and follow the vehicle manufacturer's tire replacement recommendations and restrictions.

Plus sizing is generally conveyed in terms of "Plus 1," "Plus 2," "Plus 3," etc. Examples of plus sizing are illustrated in Figure 23. If tire fitments other than the OE tire are desired, always consult vehicle and tire manufacturers' recommendations and consider the following:

- **Aspect Ratio:** Additional consideration should be made for substitute tires that are lower in aspect ratio than the OE tire fitments. Lower aspect ratio tires typically aid performance and handling, but they may provide a less comfortable ride. High performance, low aspect ratio tires may also wear more quickly and produce more noise during operation. Low aspect ratio tires and their rim/wheel assembly are more susceptible to damage from road hazards and pothole/curb impact.

- **Overall Diameter:** Check to be sure that the overall diameter of all four tires is within the accepted tolerance of the vehicle manufacturer.
- **Inflation Pressure:** Check to see if it needs to be adjusted (see "Important Considerations" on p. 39).
- **Load-Carrying Capacity:** Must be equal to or greater than the load-carrying capacity of the OE tire size at the specified vehicle tire placard pressure.
- **Speed Symbol/Category:** Must be equal to or higher than the OE fitment if the speed capability of the vehicle is to be maintained. See "Important Considerations" on p. 39.
- **Rim Width/Off-Set:** Check OE/rim manufacturer's recommendations.
- **Rim/Wheel Selection:** Never exceed the maximum pressure and/or load capacity of the rim/wheel.

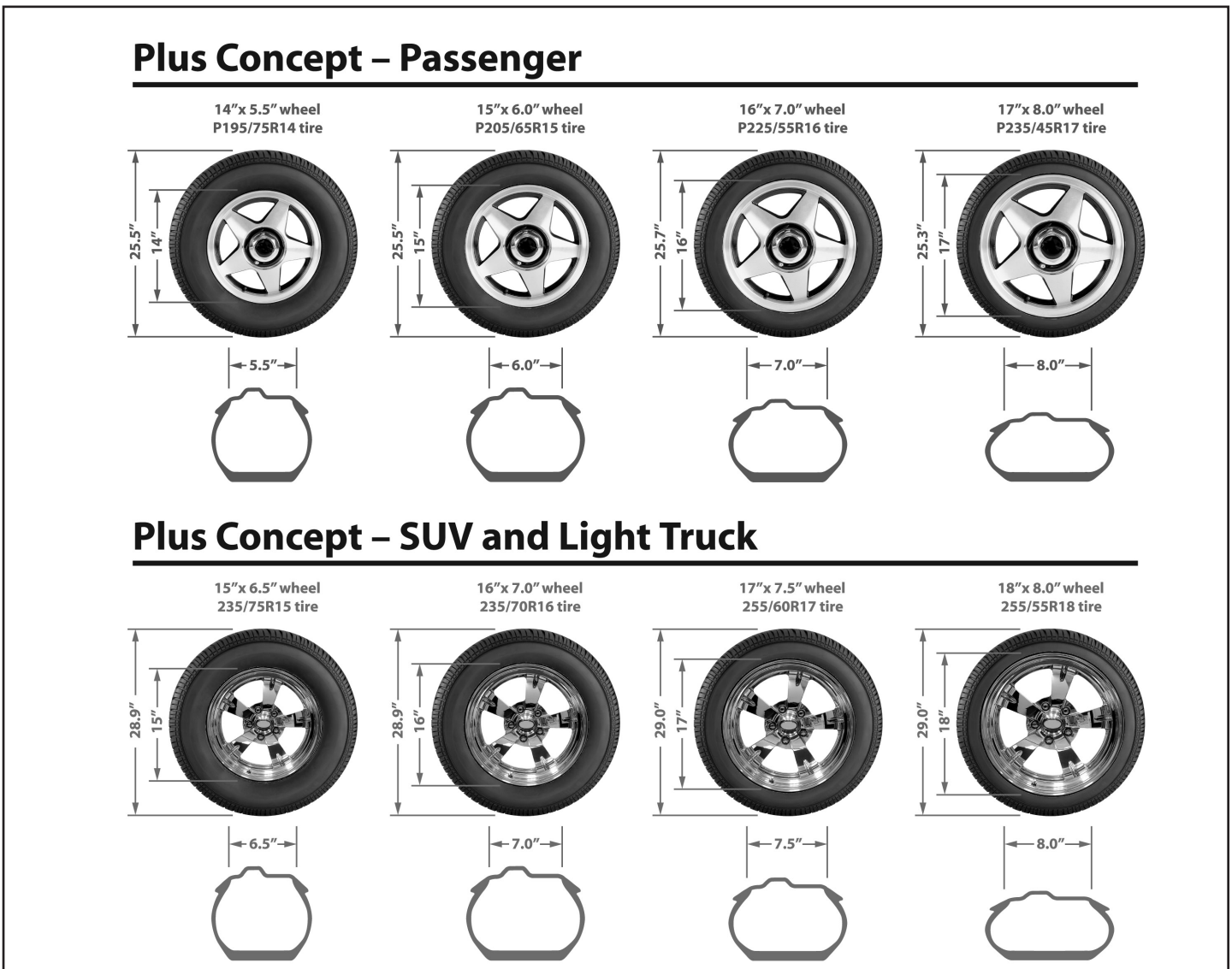

FIGURE 23: Plus Size Concepts - Hypothetical Examples

- **Vehicle Clearances:** Steering tires must be checked in full left and right turns. All wheel positions should be checked for proper clearance in fender wells, around brake components, shock towers, and other suspension components. These wheel positions must be checked for full suspension jounce and rebound.
- **Vehicle Modifications:** Lift kits and other types of suspension alterations or use of tires not approved by the vehicle or tire manufacturer can adversely affect vehicle handling and stability.
- **State/Local Laws:** Check to be sure that the fitment complies with any state/local regulations.

Important Considerations

Inflation Pressure: OE vs. Replacement

If fitment of a new tire (other than the OE size) on the vehicle requires a higher inflation pressure than specified on the vehicle tire placard to adequately carry the load, the installer should inform the owner of the new required inflation pressure. The installer should also place a sticker or decal next to the vehicle tire placard showing the new tire size and inflation pressure requirements for future reference. Never inflate a tire below the recommended pressure shown on the vehicle's tire placard.

Standard Load (SL) vs. Reinforced or Extra-Load (XL) Fitments

Some passenger tires have extra load capabilities. Generally, these tires will have "XL" or "Extra Load" or "Reinforced" molded on the sidewall of the tire. Special care should be exercised when considering reinforced or extra load ("XL") tires as substitutes for standard load ("SL") tires. A reinforced or "XL" tire offers higher maximum load capacity than a "SL" tire of the same size; however:

- "XL" tires require higher inflation pressure to attain the added load capacity. (See "Inflation Pressure" above.)
- For "XL" tires, an equal or greater load index is not always an adequate indicator of a tire's suitability for the load capacity. As a result, the maximum load capacity and inflation pressure, which is also molded on the tire sidewall, must be referenced.

Load Index

- The load index is the number preceding the speed symbol on a tire's sidewall. For example, if the tire is labeled as P215/65R15 95H, then "95H" is the "service description" where "95" is the "load index." For more detailed information, see p. 9 in Chapter 1.
- Tires with the same load index, regardless of the tire size, may carry the same load, but not always, and they may require different inflation pressures. In addition, some tire sizes are available in more than one load index. The load index may not be used independently to determine replacement tire acceptability for load capacity. An equal or greater load index does not always correspond to equal or greater capacity at all inflation pressure settings, particularly when comparing P-metric and Euro-metric passenger car tires. Refer to the tire manufacturer's recommended inflation pressures for the tire selected (see "Inflation Pressure: OE vs. Replacement").

Speed Rating

- Speed rating of the tire must be equal to or greater than what is specified by the vehicle tire placard, or owner's manual, if the speed capability of the vehicle is to be maintained. For example, if the tire is labeled as P215/65R15 95H, then "95H" is the "service description" where "H" is the "speed symbol."
- If replacement tires have lower speed capability than specified by the vehicle manufacturer's recommendations, the vehicle's speed must be restricted to that of the replacement tire. Also, vehicle handling could be affected. Consult vehicle or tire manufacturers.
- If the vehicle manufacturer's recommendations do not call for speed rated tires, replacement tires may be speed rated if desired.
- If installing winter/snow tires and if the vehicle tire placard specifies speed rated tires, winter/snow tires of equivalent or greater speed rating must be fitted if the speed capability of the vehicle is to be maintained. For cases where the winter/snow tire speed rating cannot match the OE tire, it is generally acceptable to apply a winter/snow tire with a lower speed rating than the OE tire; however, the vehicle speed is to be restricted to that of the replacement tire. Refer to the vehicle owner's manual for specific recommendations and/or restrictions regarding winter/snow tires.

Passenger and Light Truck Used Tires

This information pertains to used passenger and light truck tires installed as replacement tires or as equipped on a used vehicle. Refer to USTMA Tire Information Service Bulletin, Vol. 45, "Passenger and Light Truck Used Tires."

Once tires are applied to a vehicle and put into service (this includes spare tires), they are considered "used." There is a potential risk associated with the installation of used tires that have uncertain or unknown history of use, maintenance or storage conditions. Such tires may have damage that could eventually lead to tire failure.

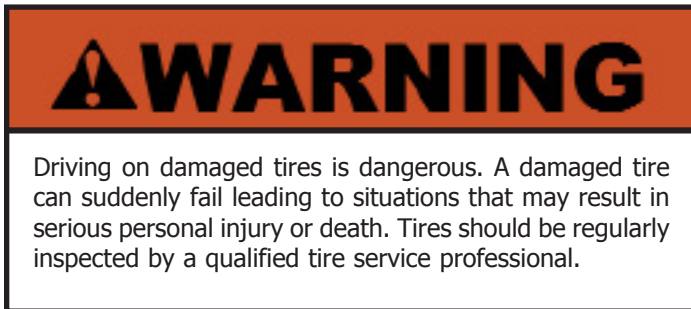

Not all tire damage that can lead to tire failure is outwardly visible. For instance, improper repairs or damage to a tire innerliner can only be observed by inspecting the inside of the tire, demounted from the wheel. A qualified tire service professional should inspect the internal and external condition of the used tires prior to application. In the case of a used vehicle purchased by a consumer, the only way to determine the condition of its tires is to have them demounted by a tire service professional for the same type of inspection.

USTMA does not recommend the installation of used tires that exhibit any of the following characteristics:

- Any punctures or other penetrations, whether repaired or not.
NOTE: This is not meant to preclude the proper repair of a tire installed on a consumer's vehicle when the consumer is aware of the tire's history. (See USTMA wall chart "Puncture Repair Procedures for Passenger and Light Truck Tires")
- Any innerliner or bead damage.
- Indication of internal separation, such as bulges or local areas of irregular/fast treadwear indicating possible tread or belt separation.
- Indication of run-flat, under inflated and/or overloaded damage (e.g. innerliner abrasion, mid- to upper sidewall

- abrasion and stamping deterioration, delamination, or discoloration, excessive tread shoulder wear, etc.).
- Any damage or wear exposing the body material of the tire — cuts, cracks, bulges, scrapes, ozone cracking/weather checking, impact damage, punctures, splits, snags, etc.
- Defaced or removed DOT tire identification number (TIN), which is located on the tire sidewall.
- Involved in a recall or a replacement program.
- Inadequate tread depth for continued service (i.e. nearly worn out). Tires with a tread depth of 2/32" or less at any point on the tire are worn out.
- Currently mounted on a rim that is bent, dented, cracked or otherwise damaged.
- Evidence of improper storage. Refer to USTMA Tire Information Service Bulletin, Vol. 23, "Tire Storage Recommendations."
- Chemical, fire, excessive heat damage, or other environmental damage.
- Designated as a "scrap tire" or otherwise not intended for continued highway service.
- Evidence of prior use of tire repair sealant.
- Physically or chemically altered in any way (except by proper retreading) to change appearance or performance, including either sidewall and/or the tread (such as by regrooving or siping).
- Labeled on the sidewall as "Not For Highway Use", "NHS", "For Racing Purposes Only", "Agricultural Use Only", "SL" (service limited agricultural tire), or any other indication that the tire is barred from use on public thoroughfares.
- Any other condition which would be cause for permanent removal from service. For more about out-of-service tire conditions, refer to the Tire Industry Association's "Passenger and Light Truck Tire Conditions Manual."

Overview

This chapter contains additional guidelines to help obtain the best performance from tires used on RVs. Use this chapter in conjunction with the other chapters in this manual. Unless otherwise specified: 1) the term "RV" applies to: motor homes; travel trailers; 5th-wheel travel trailers; and, slide-in campers for pickup trucks, and 2) the term "RV tires" identifies all tires used on RV vehicles. More information about the specific vehicle and its tires is contained in the owner's manual supplied by the vehicle manufacturer. Additional information concerning RV tires is available from the tire manufacturer.

Over the years, the Recreational Vehicle Safety & Education Foundation (RVSEF) has weighed tens-of-thousands of motor homes and travel trailers in conjunction with RV events. Of the RVs checked by RVSEF, more than 50 percent had loads that exceeded the capacity of one or more tires on the vehicles. Other surveys have noted that many RV's have one significantly under inflated tire that is at risk of failure.

An under inflated tire cannot adequately carry the load placed upon it and will be subjected to excessive stress, strain, and heat build-up which can lead to tire failure. Also the under inflated tire in a dual pair can cause a weight transfer to the properly inflated tire resulting in it being over loaded which may lead to tire failure. Often, these significantly under inflated tires were the inner tires of dual pairs, tires that are more difficult to see and service. On average, RVs were over loaded by over 900 pounds, based on the RV manufacturer's specifications.

RV Tire and Vehicle Placards/Labels

In order to determine specifications for tire size, tire inflation pressure, and vehicle loading, it may be necessary to consult different placards/labels depending upon the vehicle type, model year, and manufacturer. These placards/labels include the following:

- Vehicle Certification Label
- Vehicle Tire Placard
- Motor Home Occupant and Cargo Carrying Capacity Label
- RV Trailer Cargo Carrying Capacity Label
- Motor Home Supplemental Label
- RV Trailer Supplemental Label
- Load Carrying Capacity Modification Label

These placards/labels may be found in different locations depending upon the vehicle, including the following:

Left Side: Driver's door edge, hinge pillar, or door-latch post.
 Right Side: Forward-most exterior passenger door edge, hinge pillar, or door-latch post.

Vehicle Interior: Posted on a surface near the driver or storage area.

Vehicle Exterior: Posted on surface near the trailer hitch.

The type of important tire and loading information on the placards/labels includes the following:

1. Gross Vehicle Weight Rating (GVWR)
2. Gross Axle Weight Rating (GAWR) for each axle
3. Tire and wheel/rim sizes
4. Recommended cold tire inflation pressures

Consult the vehicle owner's manual for additional tire and loading information. Follow the vehicle tire placard, certification label and owner's manual for recommended vehicle load limits and tire inflation pressures.

TIRE AND LOADING INFORMATION
 Seating Capacity | Total:6 | Front:3| Rear:3
 The combined weight of occupants and Cargo should not exceed 9711 Kgs or 21408 Lbs

TIRE	SIZE	COLD TIRE PRESSURE	SEE OWNER'S MANUAL FOR ADDITIONAL INFORMATION
FRONT	245/70R19.5F	92 PSI / 635 KPA	
REAR	245/70R19.5F	92 PSI / 635 KPA	
SPARE	245/70R19.5F	92 PSI / 635 KPA	

MANUFACTURED BY / FABRIQUE PAR: FOREST RIVER, Inc DATE: 3/30/2010
 V.I.N./N.I.V: 5ZTAMD008B1504998 1F66F5DYXB0400211 MDA35DSF
 GVWR/PNBV: 9979 KG (22000 LB) TYPE/TYPE: MH/AC
 DESIG. SEAT CAP./NOMBRE 'D'ESIGNE' DE PLACES ASSISES 6X70kg=420 kg or 6X150lbs=900 lbs

	GAWR/PNBE	TIRE/S/PNEU	RIMS/JANTE	COLD INFL. PRESS/PRESS. DE CONFL. A FROID
FRONT/ AVANT	3402 KG (7500 LB)	245/70R19.5F	19.5X6.75	635 KP SINGLE DUAL 92 PSILP <input checked="" type="checkbox"/> <input type="checkbox"/>
INTERM/ NTERM	0 KG (0 LB)			0 KP SINGLE DUAL 0 PSILP <input type="checkbox"/> <input type="checkbox"/>
REAR/ ARRIERE	6577 KG (14500 LB)	245/70R19.5F	19.5X6.75	635 KP SINGLE DUAL 92 PSILP <input type="checkbox"/> <input checked="" type="checkbox"/>

MOTOR HOME OCCUPANT AND CARGO CARRYING CAPACITY:
 Dry Weight: 15462 VIN: 4X4MGTK23B0017182 1F66F5DY5B0400211
 THE COMBINED WEIGHT OF OCCUPANT AND CARGO SHOULD NEVER EXCEED:
 1976 kg or 4356 lbs
 Safety belt equipped seating capacity: 6
 CAUTION:
 A full load of water equals 188 kg or 416 lbs of cargo @ 1 kg/L (8.33 lb/gal) and the tongue weight of a towed trailer counts as cargo

FIGURE 24: Examples of RV Tire and Vehicle Placards/Labels

When replacing RV tires, refer to the certification label for the tire size(s) and load range recommended by the RV manufacturer. If replacing with a tire size other than shown on the certification label, consult the RV manufacturer or tire service professional for recommendations. Using the wrong tire size or load range can lead to tire failure.

Vehicle modifications such as lift kits and other suspension alterations and/or use of tires not recommended by the vehicle or tire manufacturer can adversely affect vehicle handling and stability.

Tires specifically designed for travel trailer use in highway service have an "ST" molded on the tire sidewall such as ST225/75R15. Also see Chapter 1 "Basic Tire Information." ST tires have different load capacity characteristics. Therefore, ST tires should not be replaced with any other type tire.

RV Tire and Vehicle Load Limits

To avoid overloading RV tires, maintain the proper inflation pressure and never exceed the vehicle's Gross Axle Weight Ratings (GAWR) or the Gross Vehicle Weight Rating (GVWR) stated on the certification label. The vehicle load must also be distributed so that no individual axle, tire or dual assembly is over loaded.

The maximum load for each tire is molded on the tire sidewall (along with the maximum inflation pressure for that load). Never exceed the stated maximum limits on the tire, rim or wheel assembly.

The major components of an RV - the vehicle frame, brakes, axles, rims/wheels, tires, etc. - are designed to accommodate a particular weight. If these weight ratings are exceeded, these parts may wear rapidly or may fail prematurely in-service. The RV manufacturer provides the weight ratings and load specifications printed on the vehicle tire placard or certification label as follows:

- **GVWR: Gross Vehicle Weight Rating** - The weight rating established by the chassis manufacturer as the maximum weight (including vehicle, cargo, liquids, passengers, etc.) the components of the chassis are designed to support.
- **GAWR: Gross Axle Weight Rating (for each axle)** - The maximum weight rating that the components (tires, rims/wheels, brakes, springs, and axle) of each axle are designed to support. This is determined by the lowest design capacity of any component. In other words, if the wheels have the lowest design capacity of any component on that axle, installing tires with a higher load capacity does not increase the GAWR. By regulation, the tire load

rating times the number of tires on that axle must equal or exceed the GAWR for that axle.

- **GCWR: Gross Combined Weight Rating** - GCWR represents the maximum allowable total loaded weight rating of the vehicle and any vehicle/trailer it is towing. GCWR minus GVWR represents the allowable weight for the towed vehicle.
- **GVW: Gross Vehicle Weight** - GVW is the actual weight of a fully loaded vehicle, including vehicle, cargo, liquids/fuels, passengers, tongue weight, etc. The GVW must not exceed the GVWR. (Tongue weight is the downward weight exerted at the hitch or 5th wheel connection by a fully loaded towed trailer. The towing vehicle's tires - not the towed trailer's tires - support this weight.)
- **GAW: Gross Axle Weight** - GAW: Gross Axle Weight GAW is the actual weight of a fully loaded vehicle carried by a single axle. Due to the many ways that weight can be distributed within an RV, GAW can often provide a false sense of security. The total weight on an axle may be within the axle's rating, but the distribution of the load may be overloaded on one side. The GAW must not exceed the GAWR.

Proper RV Tire Inflation

The recommended inflation pressures for RV tires are indicated on the vehicle tire placard, certification label, or in the owner's manual. Never set tire inflation pressures below the recommended inflation pressure found on the vehicle tire placard, certification label or owner's manual. Under inflation causes excessive heat build-up and internal structural damage that may lead to a tire failure, even at a later date. Do not exceed the maximum inflation pressure shown on tire sidewall. Over inflated tires (over the maximum molded on the tire sidewall) are more likely to be cut, punctured or damaged by sudden impact from hitting an obstacle, such as a pothole.

To maintain the correct pressure in RV tires, check the inflation pressure regularly with a dual-head pressure gauge that is calibrated up to 120 psi in at least 2 psi increments. Even if it is difficult to check the inflation pressures of inside tires in dual fitments, it is imperative that these inflation pressures be checked and properly maintained because the inside dual tires are subjected to more severe operating conditions, such as:

- High heat exposure, due to close proximity to brakes
- Lower air circulation to assist in cooling
- Crowned road surfaces (which can cause inside dual tires to support more of the load than the outside dual tires)

Proper Inflation is Critical

Inflation pressure enables a tire to support the load and to control the vehicle, therefore proper inflation is critical. With the right amount of inflation pressure, the vehicle and the tires will achieve their optimum performance. In addition to tire safety, this means your tires will wear longer and improve vehicle fuel consumption.

It is impossible to determine whether radial tires are properly inflated just by looking at them. You must use a tire gauge to properly check the inflation pressure. Motorists should have their own gauge and keep it in the vehicle.

When To Check Inflation Pressure

Check inflation pressure when tires are cold, that is, when the vehicle has been parked for at least 3 hours or has been driven less than one mile at moderate speed. The inflation pressure in all tires, including the spare tire and inside duals, should be checked with an accurate tire gauge at least once per month, before each trip and each morning you drive during a trip. This includes vehicles equipped with a Tire Pressure Monitoring System (TPMS). Maintaining proper inflation pressure maximizes fuel economy and optimizes overall tire performance.

Never “bleed” or reduce inflation pressure when tires are hot from driving, as it is normal for pressures to increase above recommended cold pressures. If a hot tire pressure reading is at or below recommended cold inflation pressure it may be dangerously under inflated.

In this case, immediately determine the cause and/or have the tire checked by a tire service professional.

A passenger or light truck tire used on an RV may lose 1 to

2 psi inflation pressure per month under normal conditions and 1 to 2 psi for every 10°F temperature drop. Truck/bus tires may lose more due to their higher operating pressures. If an RV tire continually loses more than 2 psi per month (4 psi for truck/bus tires), have it checked by a qualified tire service professional.

Significant changes in altitude or temperature at which a vehicle will regularly operate, will result in changes in inflation pressure and will require an inflation pressure check and adjustment.

Valves

Metal valve caps with rubber seals are recommended for RV applications due to generally higher operating pressures. The metal cap with a rubber gasket provides a seal that a plastic valve cap may not provide. Refer to USTMA Tire Information Service Bulletin, Vol. 40, “Tubeless Type Valves for Passenger and Light Truck Tires Including Tubeless Snap-In Tire Valve Installation Procedure”.

Bolt-in (clamp-in) metal valve stems are recommended for RV applications. They must be used when valve extensions are installed because the extra weight of the extension or hose can distort rubber stems and ultimately cause loss of inflation.

When dual tires are mounted on a vehicle, they should always be installed with the valve stems 180 degrees apart (for example, if one valve is at the 6 o’clock position then the other should be at the 12 o’clock position).

It may be necessary to install an extension hose with a bolt-in (clamp-in) metal valve stem to check inflation on an inside dual tire in some applications. It is recommended to

WARNING

Under inflation and/or over loading of a tire causes excessive heat build-up and internal structural damage. This may cause a tire failure, including tread/belt separation, even at a later date, which can lead to an accident and serious personal injury or death.

Over loading an RV can have other serious safety consequences such as suspension or wheel failure, increased braking distance or brake failure (particularly on steep grades), and adverse vehicle handling/stability.

Consult the vehicle tire placard, certification label and owner’s manual for the recommended vehicle load limits and tire inflation pressures.

use extension hoses with stainless steel reinforcement and external braiding as protection. The ends of the hoses should be securely attached to the wheels so that they cannot come loose while driving. If the holes in the wheels are too small or in the wrong place to be able to check inflation pressure on the inside tires, this situation must be corrected before travel.

NOTE

Install a new valve assembly whenever a tire is replaced. Rubber valve stems must always be replaced when tires are replaced. In some instances, tire/wheel assemblies may be equipped with a Tire Pressure Monitoring System (TPMS) sensor that is attached to or is part of the valve assembly. When new tires are installed, it is recommended to also replace all components that are included in the TPMS valve replacement kit.

Determining Proper Inflation Pressure

Use of the tires, wheels, and inflation pressures as specified on the vehicle tire placard, certification label or in the service manual ensures that these components can carry the maximum rated axle loads (GAWR) and maximum vehicle weight (GVWR), and also maintains other performance characteristics, if any, intended by the vehicle manufacturer. At a minimum, the tires on each axle should not be over loaded or under inflated if the vehicle is properly loaded.

With actual weights of the loaded RV acquired by weighing, it is possible to compare them against the GAWR, GVWR, and tire capacities posted on the vehicle tire placard or certification label. These actual weights are also what should be used to determine any increase in inflation pressure for the tires, if required. See "How to Determine an RV's Actual Weight" on p. 45.

Inflation pressure recommendations may also be determined based on the tire manufacturer's specifications, which define the amount of inflation pressure necessary to carry a given load. These inflation pressures may differ from those found on the vehicle tire placard or certification label.

However, never use inflation pressure lower than specified by the vehicle tire placard, certification label or owner's manual. Nor should inflation pressure exceed the maximum pressure molded on the tire sidewall.

Load and cold inflation pressure imposed on a rim/wheel must not exceed the rim/wheel manufacturer's recommendation, even though the tire may be marked for a higher load and

inflation. Matching radial tires with rim/wheels must be done with care. Older rims/wheels may not be approved for use with radial tires. Consult the RV or the rim/wheel manufacturer for acceptable rims/wheels for a specific radial tire.

Proper RV Tire and Vehicle Loading

Tires used on RVs are typically subjected to a greater variety of loading conditions, often at or near maximum loads, than automobile, light truck and truck applications.

Many RVs end up over loaded simply because people put too many things in them. There is often no quick way to determine the weight of the items loaded, so there is a temptation to keep loading until most of the available space is filled. Most people tend to load by volume when weight is far more important. Unfortunately, these circumstances will tend to exceed the load-carrying capacity of the tires or axles long before everything is on board. The only way to determine if the vehicle is over loaded is to have it weighed. See "How to Determine an RV's Actual Weight" on p. 45.

It is also possible to be within the overall vehicle's weight rating (Gross Vehicle Weight Rating or GVWR), yet still have over loaded axle ends or tires. That occurs because the load is not distributed evenly. Proper weight distribution may be difficult to determine when loading a vehicle. The vehicle load can be unevenly distributed from front to rear or side-to-side. Uneven loading may cause the load to be within an axle or tire's load-carrying capacity on one end of an axle, and over capacity on the other. Some types of load-leveling systems compensate for uneven weight distribution, making it more difficult to notice. Properly weighing the vehicle is the only way to be sure.

The most critical point about weighing a vehicle is that it must be weighed fully loaded (including everything that will be on board while traveling). That means the vehicle must be weighed with passengers, supplies, food, water, fuel, oil, towed items, bicycles, clothing, propane, etc. Note that water, fuel, and propane can easily exceed 750 lbs.

The Gross Axle Weight Rating (GAWR) or the Gross Vehicle Weight Rating (GVWR) must never be exceeded. If any tire's maximum load capacity is not adequate to support the actual weight on that tire position, there are two choices:

- 1) Lighten the load
- 2) Install tires with a higher load-carrying capacity

If it is decided to install a tire size other than that originally provided on the vehicle, care must be taken to ensure adequate load-carrying capacity and compatibility between the tire and rim. Always supply a detailed weight slip for the vehicle, listing individual wheel position load information, to a tire service professional before proceeding. This is the only way a tire service professional can determine which tire size has adequate load capacity and is capable of proper inflation pressure. If the vehicle has dual rear tires, installing a tire size other than the original size will require proper matching and spacing of the dual tire assembly. If chains are used, particular care must be taken to assure adequate clearance between loaded tires to avoid damage from chains. Consult a tire service professional for proper application.

How to Determine an RV's Actual Weight

The only sure way to determine actual weights is to weigh the fully loaded RV, wheel position by wheel position and axle by axle, on level commercial scales. Individual wheel position weights are the most critical for accurate load determination. Certified public scales may be found at moving and storage lots, farm suppliers with grain elevators, gravel pits, recycling companies, and commercial truck stops. Allow adequate time since the entire process can take up to 30 minutes. There may be a small fee for each weight taken, but the expense is a worthwhile investment towards the safe and economical operation of the vehicle.

For the weighing of the RV to be meaningful, it must be weighed fully loaded including: passengers, food, clothing, fuel, water, propane, supplies, etc. Any towed vehicle (car/pickup, boat, or trailer) or any item loaded on brackets on the back of the RV, such as bicycles, motorcycles, storage units, etc., should also be included in the weighing.

Portable Wheel Position Scales

The most effective method of determining wheel position weights is to use portable scales designed for individual wheel position measurement. Place a scale at each wheel position and record the load.

Fixed Scales

- **Platform** - long enough to weigh the complete vehicle. Follow the steps on pages 48 to 50 for your particular vehicle to determine individual position loads.
- **Segmented Platform** - provides individual axle weights and total vehicle weights simultaneously when the vehicle is positioned properly. These scales provide an easier method to determine individual position loads.
- **Single Axle Platform** - This scale weighs one axle at a time (all tires on the same axle). These scales provide an additional method to determine individual position loads.

Regardless of the method used, the RV must remain as level as possible, even if an axle or side is not physically on the scale. There must be enough space on the side of the scale to accommodate the RV being partially off the scale.

If there is a difference in the weights on one side of the vehicle compared to weights on the other side, suspension components (tires, wheels, brakes, springs, etc.) on the heavier side could be overloaded, even if the total axle load is within the GAWR.

Redistributing the load is essential to avoid component failure, as well as to improve the handling characteristics of the vehicle.

The actual or calculated weights can be compared with the GAWR, GVWR and tire capacities. The weights also help determine the proper inflation pressure for the tires.

WARNING

Under inflation and/or over loading of a tire causes excessive heat build-up and internal structural damage. This may cause a tire failure, including tread/belt separation, even at a later date, which can lead to an accident and serious personal injury or death.

Over loading an RV can have other serious safety consequences such as suspension or wheel failure, increased braking distance or brake failure (particularly on steep grades), and adverse vehicle handling/stability.

Consult the vehicle tire placard, certification label and owner's manual for the recommended vehicle load limits and tire inflation pressures.

NOTE

Installing tires with a higher load-carrying capacity does not affect the load capacity of other components (i.e. rims/wheels, axles, shocks, bearings, etc.). Rims may not be rated to withstand the load or higher inflation pressures necessary to support the load. If the load cannot be adequately reduced, refer to the RV manufacturer recommendations.

How to Weigh a Travel Trailer

1. Weigh the travel trailer in its entirety while detached from the towing vehicle. The overall weight must be less than or equal to the GVWR for safe operation. If the overall weight is greater than the GVWR, contents must be removed until GVWR limitations are achieved.
2. Weigh the travel trailer while attached to the towing vehicle. The towing vehicle should not be on the scale. The result is the weight exerted on all of the trailer tires. Subtract this weight from the overall weight in Step 1 (above) to determine "tongue" weight.
3. With the trailer still attached to the towing vehicle, each wheel position should be weighed separately to be sure each tire is not over loaded. If an over load condition exists on any wheel position, trailer contents must be redistributed or removed.
4. The individual wheel positions (particularly the rear positions) on the towing vehicle should also be weighed while the trailer remains attached. This is especially important on 5th-wheel applications. If an over load condition exists on the towing vehicle, trailer contents must be redistributed or removed and Steps 2 through 4 must be repeated.

Refer to the diagrams on p. 48 to 50 to record your results.

NOTE

It is not uncommon for an axle weight to be within the load limits of the axle, but improperly distributed side-to-side, causing an over load condition on one of its wheel positions. Therefore, side-to-side weighing should also be done.

RV Tire Inspection Guidelines

In addition to maintaining inflation, regularly inspect the tires' tread and sidewalls for irregular tread wear, cracking, scrapes, bulges, cuts, snags, foreign objects or other damage resulting from use. It is recommended that RV tires, including the spare, be periodically inspected by a tire service professional, including an inspection before every travel season and during routine RV maintenance intervals like oil changes and tire rotations.

Remove any stones, glass, foreign objects, etc. embedded in the tread to prevent damage. Even minor damage can lead to further injury and eventual tire failure. Also, it is a good practice to check between dual tire/wheel assemblies for foreign objects, like large rocks, that may have become lodged between the tires, especially after off-road service.

Tires with excessive cracking on the tread or sidewall(s) should be removed from service. This is typically caused by under inflation, over loading, improper storage, and/or improper long-term parking. RV tires should be checked for this condition and any other damage before every trip.

For more information regarding tire inspection guidelines and tire damage, see Chapter 2, "Tire Care and Service."

Replace tires when worn to 2/32" (1.6 mm) depth remaining anywhere on the tread face. For RV's with a GVWR in excess of 10,000 pounds (4,536 kg), regulations may require that tires on the front axle should be removed when worn to 4/32" (3.2 mm) tread depth.

Severe Service Operation

RV tires will wear out faster when subjected to high speeds and high loads as well as hard cornering, rapid starts, sudden stops, and driving off-road or on surfaces that are in poor condition. Rocks, holes or other objects can damage tires and cause wheel misalignment. When driving on such surfaces, drive carefully and slowly. Before driving on paved roads at highway speeds, examine the tires for any damage such as cuts or penetrations.

Sudden Ride Disturbance/Vibration

If the vehicle experiences a sudden vibration or ride disturbance and/or there is a possibility the tires and/or vehicle have been damaged, gradually reduce speed. Do not abruptly brake or turn. Drive with caution until you can safely pull off the road. Stop and inspect the tire. If the tire is under inflated or damaged, deflate and replace it with the spare tire. If a cause cannot be detected, the vehicle should be towed to the nearest vehicle or tire dealer for an inspection.

Tire Rotation

Rotating tires will help even out the amount of wear on each tire and extend the serviceability of the entire set. Most RVs have a matching full-size tire as its spare. It is important that the full-size spare is included in the RVs' tire rotation. See vehicle owner's manual for rotation recommendations. If tires exhibit uneven wear, check for and correct, if possible, any misalignment, imbalance, or other mechanical problems before rotation. When tires are rotated on an RV, the inflation pressures may need to be adjusted for the tires' new positions in accordance with the actual load on that wheel position. Under or over inflated tires may result in poor vehicle handling, uneven treadwear, increased fuel consumption and tire failure. Lug nuts should be properly torqued anytime a tire/rim/wheel assembly is re-installed on the vehicle.

NOTE

Some RVs may have specific tire rotation recommendations and/or restrictions. See vehicle owner's manual.

RV Tire Service Life

Tires used on RVs are typically subjected to a greater variety of service conditions, often at or near maximum loads, than automobile, light truck and truck applications. It is important to have the RV and its tires in good operating condition.

Even though RV users often put no more than a few thousand miles on their tires a year, RV tires may need to be replaced because of service conditions long before the tread is worn out. To determine if RV tires, including the spare, should remain in service, it is recommended that they be periodically inspected by a tire service professional, including

an inspection before every travel season and during routine RV maintenance intervals like oil changes and tire rotations. The service life of tires includes their overall condition and vehicle usage factors, not just tread wear. All of these factors should be taken into account when considering tire replacement. See "RV Tire Inspection Guidelines" on page 46.

WARNING

Driving on damaged tires is dangerous. A damaged tire can suddenly fail leading to situations that may result in serious personal injury or death. Tires should be regularly inspected by a qualified tire service professional.

Follow vehicle and tire manufacturers' specific recommendations, if any, regarding tire service life and replacement. In order to determine the age of the tire, look for the last four digits of the DOT tire identification number (see Chapter 1, "Basic Tire Information" for details). For example, a tire with a DOT tire identification number ending with the last 4 digits of 0312 indicates it was manufactured the 3rd week of 2012.

RV tires that have been permanently removed from service should be rendered unserviceable and destroyed so no one else can use them.

Tire Service Life is Not Determined by Chronological

Age - Tires are composed of various materials, including rubber, having performance properties essential to the proper functioning of the tire. These component properties evolve over a combination of time, service and storage conditions. For each individual tire, this change is affected by many elements such as temperature, storage conditions, and conditions of use (e.g., load, speed, inflation pressure, impacts and road hazard injury) to which a tire is subjected throughout its life. Since service and storage conditions vary widely, accurately predicting the service life of any specific tire based on calendar age is not possible. USTMA is not aware of scientific or technical data that establishes or identifies a specific minimum or maximum service life for passenger and light truck tires. However, in some cases a tire or vehicle manufacturer may make a specific tire replacement recommendation regarding its products. If so, the consumer should consult the manufacturer with any questions with regard to following the recommendation. Further, any such recommendation should not be considered a minimum service life for the tire.

Weighing an RV or Travel Trailer

Depending on the type of vehicle, use the Illustrations on p. 48, 49 or 50 to assist in weighing. For additional assistance or information, consult with an RV or tire service professional.

WARNING





The vehicle weight at each particular wheel position must not exceed the maximum tire load capacity. Over loading the tire/wheel assembly may lead to tire or wheel failure, which may result in an accident, serious personal injury or death.

NOTE

Maximum tire load capacity can only be achieved utilizing the maximum inflation pressure molded on the sidewall of the tire.

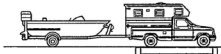
Weighing a Single Axle Recreational Vehicle

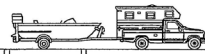
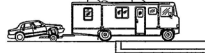
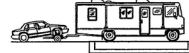
RV: To Obtain Axle and Gross Vehicle Weights

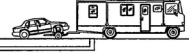
	STEP 1a	STEP 1b	STEP 1c	STEP 1d
				
				
Scale Weight	_____ lbs. (Step 1a = GAW)	_____ lbs. (Step 1b = GVW)	_____ lbs. (Step 1c = GAW)	_____ lbs. (Step 1d)
From Owner's Manual	_____ lbs GAWR	_____ lbs. GVWR	_____ lbs. GAWR	_____ lbs. Vehicle Weight (GCWR-GVW)

RV: To Obtain Individual Wheel Position Weights

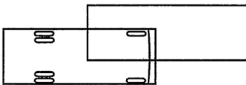
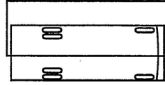
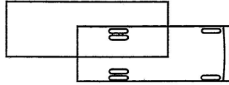

	STEP 2a	STEP 2b	STEP 2c
			
One Side Scale Weight	_____ lbs. (Step 2a)	_____ lbs. (Step 2b)	_____ lbs. (Step 2c)
Calculate Other Side Weight	_____ lbs. (Step 1a-2a)	_____ lbs. (Step 1b-2b)	_____ lbs. (Step 1c-2c)
Tire Load (lbs.)	_____ lbs. (See Note #1)		_____ lbs. (See Notes #1 & 2)
Inflation	_____ psi (See Note #1)		_____ psi (See Note #1)

Note #1: From the tire manufacturer's load and inflation tables or the sidewall of the tires mounted on the vehicle.

Note #2: If vehicle has duals, read dual capacity from tire and multiply by two (2) to obtain dual assembly load carrying capacity.

Weighing a Tandem Axle Recreational Vehicle

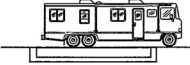
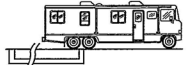

RV: To Obtain Individual Axle and Gross Vehicle Weights

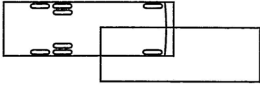
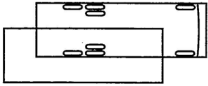
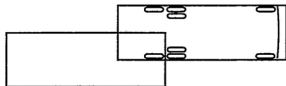
	STEP 1a	STEP 1b	STEP 1c	STEP 1d	STEP 1e
					(Calculated)
Scale Weight	_____ lbs. (Step 1a = GAW)	_____ lbs. (Step 1b = GVW)	_____ lbs. (Step 1c)	_____ lbs. (Step 1d = GAW)	_____ lbs. Drive Axle GAW = (1c-1d)
From Owner's Manual	_____ lbs. GAWR	_____ lbs. GVWR		_____ lbs. GAWR	_____ lbs. GAWR

	STEP 2a	STEP 2b	STEP 2c	STEP 2d
				(Calculated)
One Side Scale Weight	_____ lbs. (Step 2a)	_____ lbs. (Step 2b)	_____ lbs. (Step 2c)	_____ lbs. Step 2d: Right Duals = (2b-2c)
Calculate Other Side Weight	_____ lbs. (Step 1a-2a)	_____ lbs. (Step 1c-2b)	_____ lbs. (Step 1d-2c)	_____ lbs. Left Duals = (1e-2d)
Tire Load (lbs.)	_____ lbs. (See Note #1)		_____ lbs. (See Note #1)	_____ lbs. (See Notes #1 & 2)
Inflation	_____ psi (See Note #1)		_____ psi (See Note #1)	_____ psi (See Note #1)

Weighing a Pulling Vehicle and Travel Trailer

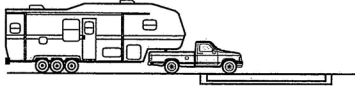
Pulling Vehicle: To Obtain Individual Axle and Gross Vehicle Weights

	STEP 1a	STEP 1b	STEP 1c
			(Calculated)
Scale Weight	_____ lbs. (Step 1a = GAW)	_____ lbs. (Step 1b = GVW)	_____ lbs. Step 1c: Rear Axle = (1b-1a)
From Owner's Manual	_____ lbs. GAWR	_____ lbs. GVWR	_____ lbs. GAWR

Note #1: From the tire manufacturer's load and inflation tables or the sidewall of the tires mounted on the vehicle.



Note #2: If vehicle has duals, read dual capacity from tire tire and multiply by 2 (two) to obtain dual assembly load carrying capacity.

Weighing a Pulling Vehicle and Travel Trailer (continued)

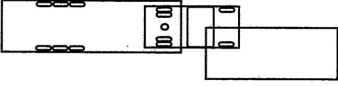
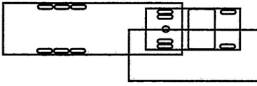
To Obtain Individual Wheel Position Weights

	STEP 2a	STEP 2b	STEP 2c
			(Calculated)
Scale Weight	_____ lbs. (Step 2a)	_____ lbs. (Step 2b)	_____ lbs. Step 2c: Right Rear = (2b-2a)
Calculate Other Side Weight	_____ lbs. (Step 1a-2a)		_____ lbs. Left Rear = (1c-2c)
Tire Load (lbs.)	_____ lbs. (See Note #1)		_____ lbs. (See Notes #1& 2)
Inflation	_____ lbs. (See Note #1)		_____ psi (See Note #1)

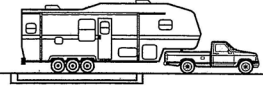
Travel Trailer: To Obtain Individual Axle and Gross Vehicle Weights

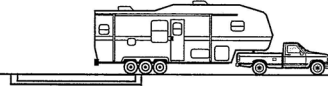
	STEP 1d	STEP 1e		STEP 1f	
					
Scale Weight	_____ lbs. (Step 1d = GVW)	_____ lbs. (Step 1e = 2 Axles)	_____ lbs. Front Axle = (1d-1e)	_____ lbs. Rear Axle = (1f)	_____ lbs. Middle Axle = (1e-1f)
From Owner's Manual	_____ lbs. GVWR	_____ lbs. GAWR	_____ lbs. GAWR	_____ lbs. GAWR	_____ lbs. GAWR

To Obtain Individual Wheel Position Weights

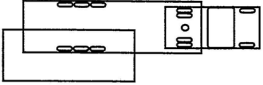
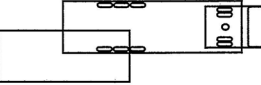
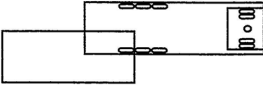
	STEP 2d	STEP 2e	STEP 2f		
					
One Side Scale Weight	_____ lbs. (Step 2d)	_____ lbs. (Step 2e)	_____ lbs. Right Front = (2d-2e)	_____ lbs. Right Rear = (2f)	_____ lbs. Right Middle = (2e-2f)
Calculate Other Side Weight	_____ lbs. (Step 1d-2d)	_____ lbs. (Step 1e-2e)	_____ lbs. Left Front = [(1d-1e)-Right Front]	_____ lbs. Left Rear = (1f-2f)	_____ lbs. Left Middle = [(1e-2e)-Left Rear]
Tire Load (lbs.)			_____ lbs. (See Note #1)	_____ lbs. (See Note #1)	_____ lbs. (See Note #1)
Inflation			_____ psi (See Note #1)	_____ psi (See Note #1)	_____ psi (See Note #1)

Note #1: From the tire manufacturer's load and inflation tables or the sidewall of the tires mounted on the vehicle.

Note #2: If vehicle has duals, read dual capacity from tire and multiply by two (2) to obtain dual assembly load carrying capacity.

Proper Tire Repair

Tires driven even a short distance while under inflated may be damaged beyond repair. Running a tire under inflated is like running the vehicle's engine without enough oil or coolant. It may seem to work fine for a time, but serious permanent damage has occurred. Adding oil or coolant won't repair engine damage, and adding inflation pressure won't fix tire damage. The tire will remain seriously damaged and can still fail, even after inflation pressure is corrected.

If a tire is losing inflation pressure, a tire service professional should check the tire surface and the valve for the source of the leak(s) by using water or a soap solution prior to demounting the tire from the rim. Mark the injured area and totally deflate the tire. Then remove the tire from the wheel being careful to avoid further damage to the tire, particularly to the bead area. Perform a complete internal inspection.

For RV's equipped with dual tire assemblies (duals), if one of the dual tires becomes significantly underinflated or flat, the other tire will carry the load for both tires, resulting in an overloaded condition. Both tires should be inspected by a tire service professional for damage. See Chapter 2, "Tire Inspection Guidelines" on p. 14.

Always read, understand and follow the USTMA puncture repair wall charts: "Puncture Repair Procedures for Passenger and Light Truck Tires" or "Puncture Repair Procedures for Truck/Bus Tires." Never repair a passenger or light truck tire with an injury that is greater than 1/4 inch (6 mm) in diameter. Never repair a load range "F" and above truck/bus tire with an injury that is greater than 3/8 inch (10 mm) in diameter.

Do not repair an injury outside the puncture repair area as shown in Figure 25.

⚠ WARNING

Improperly repaired tires can fail while in service, such as by tread/belt separation, which can lead to an accident and serious personal injury or death.

Tires must always be properly repaired as described in the USTMA wall charts, "Puncture Repair Procedures for Passenger and Light Truck Tires" or "Puncture Repair Procedures for Truck/Bus Tires."



Puncture repairs are limited to the tread area as generally depicted above. DO NOT make repairs where the injury damage extends into the shoulder/belt edge area OR where the injury extends at an angle into the shoulder area. If there is any question that the injury extends into the shoulder/belt edge area, then the tire must be scrapped.

FIGURE 25: Puncture Repair Area

Not all tires can be repaired. In addition to the USTMA puncture repair procedures, there may be additional limitations based on individual tire manufacturer repair policies. These may include the type of service such as speed rating, load index, run-flat technology and commercial application.

When repairing a tire puncture:

- Never perform a tire repair on-the-wheel
- Never use only a plug (stem)
- Never use only a patch

The basic principles for proper puncture repair:

- Remove the tire from the wheel for inspection and repair;
- Prepare the injured area;
- Fill the injury with a suitable, vulcanizing material or rubber stem that must fill the injury and keep moisture out;
- Seal the innerliner with a patch to prevent loss of inflation and keep moisture out; and,
- Re-inspect the finished repair.

Refer to the USTMA wall charts for complete step by step procedures.

⚠️ WARNING

If a tire continually loses inflation pressure or has lost all or most of its inflation pressure, it must be removed from the wheel for a complete internal inspection to check for damage. Driving on damaged tires is dangerous. A damaged tire can suddenly fail, including by tread/belt separation, even at a later date, which can lead to an accident and serious personal injury or death.

Never perform a tire repair without removing the tire from the wheel assembly for an internal inspection. Do not perform an outside-in tire repair or an on-the-wheel repair.



The photo above is an example of a tire that was operated in an underinflated condition with a puncturing object that caused dangerous, non-repairable damage to the innerliner and body ply material. This type of damage would not have been visible from the outside of the tire.

Every tire must be removed from the wheel for an inspection and to assess reparability.

⚠️ WARNING

Tire changing can be dangerous and should be done by trained personnel using proper tools and procedures. Always read and understand any manufacturer's warnings contained in owner's manuals, on the equipment, listed on websites and molded onto tire sidewalls.

Failure to comply with these procedures may result in faulty positioning of the tire and/or rim parts and cause the assembly to burst with explosive force sufficient to cause serious physical injury or death. Never mount or use damaged tires or rims.

For more information on tire mounting safety and procedures, refer to the following wall charts:

- USTMA "Demounting and Mounting Procedures for Passenger and Light Truck Tires"
- OSHA "Demounting and Mounting Procedures for Tubeless Truck and Bus Tires"
- OSHA "Demounting and Mounting Procedures for Tube-Type Truck and Bus Tires"
- OSHA "Multi-Piece Rim Matching Chart"

Parking an RV

When parking an RV for extended periods of time, it is important to make sure the vehicle is as level as possible - not only for convenience and comfort purposes, but also to avoid over load tire conditions due to weight transfers. On RVs without built-in leveling devices, it is customary to "block" the low wheel positions. Care must be taken to ensure that the tires are fully supported when using blocks.

The load on the tire must be evenly distributed on the block and in the case of duals, evenly distributed on blocks for both tires. If this isn't done properly, sidewall casing cables may be damaged, which may lead to premature sidewall fatigue and ultimate tire failure. Refer to Figure 26 for blocking methods for RVs.

Incorrect Singles

Only a portion of the tire is supporting the full load.

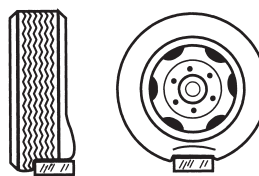

Correct Singles

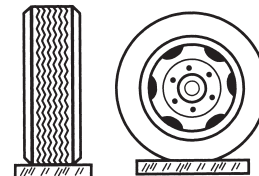

Incorrect Duals

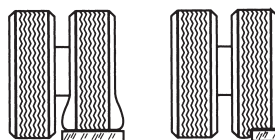

Correct Duals

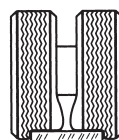
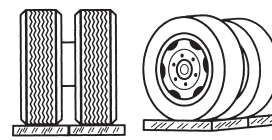

FIGURE 26: Tire "Blocking" Methods

Passenger and Light Truck Used Tires

This information pertains to used passenger and light truck tires installed as replacement tires or as equipped on a used vehicle. Refer to USTMA Tire Information Service Bulletin, Vol. 45, "Passenger and Light Truck Used Tires."

Once tires are applied to a vehicle and put into service (this includes spare tires), they are considered "used." There is a potential risk associated with the installation of used tires that have uncertain or unknown history of use, maintenance or storage conditions. Such tires may have damage that could eventually lead to tire failure.

Not all tire damage that can lead to tire failure is outwardly visible. For instance, improper repairs or damage to a tire's innerliner can only be observed by inspecting the inside of the tire, demounted from the wheel. A qualified tire service professional should inspect the internal and external condition of the used tires prior to application. In the case of a used vehicle purchased by a consumer, the only way to determine the condition of its tires is to have them demounted by a tire service professional for the same type of inspection.

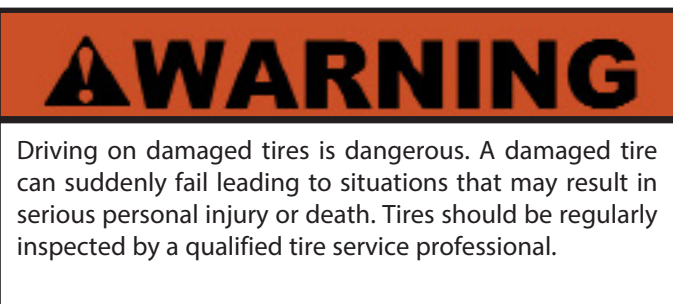

Storing RV Tires

Stored tires should be protected against environmental effects such as sunlight, high heat, ozone and other potentially damaging conditions. Refer to USTMA Tire Information Service Bulletin, Vol. 23, "Tire Storage Recommendations."

- Store tires where the area is clean, dry and well ventilated, but with a minimum of circulating air.
- Store tires in an area with temperate ambient conditions (mild temperatures, shaded or dark).
- Store tires raised off a storage area's floor surface to minimize exposure to moisture or damage.
- Avoid contact with petroleum-based products and/or other volatile solvents or substances.

- Store tires away from electric motors, battery chargers, generators, welding equipment or other ozone generating sources.

Indoor storage is recommended, however if tires must be stored outdoors:

- Store tires where they are raised off the ground (or on storage racks) and not in contact with heat absorbent surfaces.
- Protect tires with an opaque, waterproof covering with some type of vent openings to avoid creating a "heat box" or "steam bath" effect.

If tires are mounted on a stored vehicle:

Store the vehicle such that all weight is removed from the tires. If vehicle weight cannot be removed, unload the vehicle to minimize the weight. Maintain the recommended tire inflation pressure, including the spare. The surface where parked/stored should be firm, reasonably level, well drained and clean.

The vehicle should be moved every three (3) months so the tire flex area is changed.

Returning tires from storage back to service:

Before placing stored tires back into service, a tire service professional should conduct a visual and tactile inspection to be sure each tire is clean, dry, free of foreign objects, and/or does not show signs of damage. See "RV Tire Inspection Guidelines" on p. 46. Once on a rim/wheel, the tire (including the spare tire) should be inflated to the recommended inflation pressure. See "Proper RV Tire Inflation" on p. 42.

WARNING

There is a danger of serious injury or death if a tire of one bead diameter is installed on a rim or wheel of a different rim diameter. Always replace a tire with another tire of exactly the same bead diameter as the diameter of the rim on which it will be mounted. For example: a 16" tire goes on a 16" rim. Never mount a 16" tire on a 16.5" rim. A 16.5" tire goes on a 16.5" rim.

Never mount a 16.5" tire on a 16" rim. While it is possible to pass a 16" diameter tire over the lip or flange of a 16.5" size diameter rim, it cannot be inflated enough to position itself against the rim flange. If an attempt is made to seat the tire bead by inflating, the tire bead will break with explosive force and could cause serious injury or death. Rims of different diameters and tapers cannot be interchanged. The following diagram illustrates the difference between rims of two different tapers and diameters:

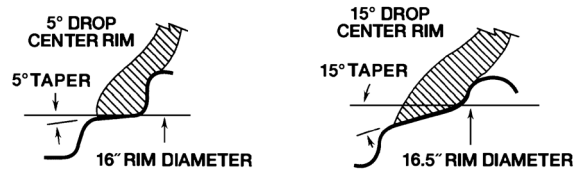

The following diagram shows how beads of a 16" tire will not seat on a 16.5" rim. The beads cannot be forced out against the rim flanges by using more air pressure because this will break the beads and the tire will explode with force sufficient to cause serious injury or death.

