



**Care and Service  
of  
Commercial Truck and Bus Tires**

## Purpose

The purpose of this manual is to provide both the tire service professional and end user (driver) with an understanding of the many factors that are essential to the proper care and service of truck and bus tires. Any reference to “truck” tires in this manual includes tires Load Range F and higher for medium trucks and buses. This manual is not all inclusive. U.S. Tire Manufacturers Association (USTMA) does not intend for it to eliminate the need for in-depth, hands-on training, especially in such areas as: tire mounting and demounting; tire and wheel balancing; tire retreading; tire pressure monitoring systems (TPMS) and tire repairing.

Personnel who service tires must receive professional training. Tire manufacturers and industry organizations, such as the Tire Industry Association\* and the Technology & Maintenance Council\*\*, provide comprehensive service and maintenance information and hands-on training programs for tire service professionals.

The “WARNINGS” contained in USTMA publications are important and must be followed. Questions pertaining to specific products or pieces of service equipment should be addressed directly to the manufacturer of that product.

USTMA does not endorse, certify, approve, consent, or confirm in any way products, brands, creations/inventions, etc. of any company, corporation, business or firm.

## Introduction

The USTMA represents companies that manufacture tires in the United States. The USTMA and its members recognize how important tires are to safety.

Tires are designed and manufactured with advanced technology and great care to provide thousands of miles of excellent service. For maximum safety, performance and service life, they must be maintained properly.

This Care and Service Manual will address these and other factors relative to the care and service of truck and bus tires. For the most current printed materials, visit the USTMA web site at [www.USTires.org](http://www.USTires.org) and click on “Publications” to search for other manuals, bulletins, wall charts, etc. For questions regarding USTMA publications, call 202-682-4800.

### THE MOST IMPORTANT FACTORS IN TIRE SAFETY, PERFORMANCE AND SERVICE LIFE ARE:

- PROPER TIRE SIZE, TYPE, AND LOAD CAPACITY (OR LOAD RANGE)
- PROPER INFLATION PRESSURE
- PROPER VEHICLE LOADING
- REGULAR TIRE ROTATION
- REGULAR INSPECTION
- PROPER TIRE REPAIR AND RETREADING
- VEHICLE CONDITION, ALIGNMENT AND MAINTENANCE
- GOOD DRIVING HABITS

## Care and Service of Commercial Truck and Bus Tires

### Chapters:

1. Basic Tire Information
2. Tire Care and Service
3. Tire Application and Replacement Guidelines
4. Repair, Retread and Regrooving
5. Demounting and Mounting Procedures including Multi-piece Rim Matching

Duplication and distribution of this work in the original form is permitted. All other rights reserved.

Copyright © 2017 U.S. Tire Manufacturers Association

\*The Tire Industry Association (TIA) is a trade association that represents all segments of the tire industry, including those that manufacture, repair, recycle, sell, service or use new or retreaded tires, and also those suppliers or individuals who furnish equipment, materials or services to the industry. Visit [www.tireindustry.org](http://www.tireindustry.org) for more information.

\*\*The Technology & Maintenance Council (TMC) of the American Trucking Associations improves transport equipment, its maintenance and maintenance management. Visit [www.trucking.org](http://www.trucking.org) for more information.

# TABLE OF CONTENTS

## CHAPTER 1 - BASIC TIRE INFORMATION

- 1 Overview
- 1 Tire Construction and Terminology
- 2 Tire Size Designations
- 4 The Sidewall Story
- 7 Types of Tread Design
- 8 Tire Registration and Recall Information

## CHAPTER 2 - TIRE CARE AND SERVICE

- 9 Overview
- 9 Proper Tire Inflation
- 13 Tire Loading
- 14 Sudden Ride Disturbance or Vibration
- 14 Tire Inspection Guidelines
- 18 Inspection Procedures to Identify Potential Sidewall “Zipper Ruptures” in Steel Cord Radial Truck, Bus and Light Truck Tires
- 22 Tire Service Life
- 23 Tire Rotation
- 24 Conditions Affecting Tread Wear
- 28 Aftermarket Sealants and Balancing Products
- 28 Used Truck Tires
- 29 Spare Tire Maintenance
- 29 Tire Storage Recommendations
- 30 Cleaning Tires
- 30 Tire Explosions and Flammable Substances
- 30 Tire Spinning
- 31 Tire/Wheel Balancing and Installation
- 31 Ride Comfort Optimization Procedures and Diagnostics
- 32 Tire Branding

## CHAPTER 3 - TIRE APPLICATION AND REPLACEMENT GUIDELINES

- 33 Overview
- 33 The Right Tire for the Vehicle
- 33 Tire Size, Speed Rating, Load and Inflation
- 36 Mixing Tire Sizes
- 36 Tire Diameter and Tire/Vehicle Clearance
- 36 Rim/Wheel, Tube and Flap Selection
- 37 Matching Dual Tires
- 37 Recreational Vehicle (RV) Applications

- 38 Use of Chains
- 38 Tire Rolling Resistance
- 39 Tire Registration and Recall Information

## **CHAPTER 4 - REPAIR, RETREAD AND REGROOVING**

- 40 Proper Tire Repair
- 41 Tire Repair Materials, Tools and Equipment
- 42 Puncture Repair
- 43 Section Repair
- 47 Bead Area Repair
- 47 Spot Repair
- 47 Preparation of Injuries to Belts Prior to Retreading
- 48 Retreading Truck Tires
- 48 Retread Tire Identification Numbers
- 49 Basic Retread Process
- 51 Outfitting with Retreads
- 51 Regrooving

## **CHAPTER 5 - DEMOUNTING AND MOUNTING PROCEDURES INCLUDING MULTI-PIECE RIM MATCHING**

- 53 Overview
- 54 Tire Selection
- 54 Lubricants, Mounting Aids and Bead Sealers
- 55 Tire Explosions and Flammable Substances
- 55 Aftermarket Sealants/Inflators
- 56 Valves and Caps
- 56 Tubes and Flaps
- 57 Tire and Rim Centering
- 58 Inflating Truck/Bus Tires
- 59 OSHA Booklet (29 CFR 1910.177):
  - Demounting and Mounting Procedures for Tubeless Truck and Bus Tires
  - Demounting and Mounting Procedures for Tube-Type Truck and Bus Tires
  - Multi-Piece Rim Matching Chart

# CHAPTER 1 - BASIC TIRE INFORMATION

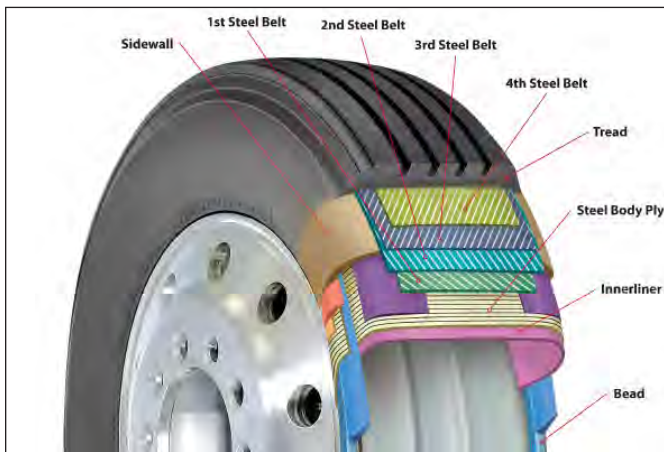
## Overview

Truck and bus tires are designed and manufactured to meet strict governmental requirements, internal company standards, vehicle performance characteristics and driver expectations. Modern tire technology blends a unique mix of chemistry, physics and engineering to give drivers a high degree of tire performance that provides safety, reliability, efficiency, long wear and comfort. Tires are manufactured, inspected and tested to assure safety and satisfaction. As a result, properly cared-for tires will provide a longer service life.

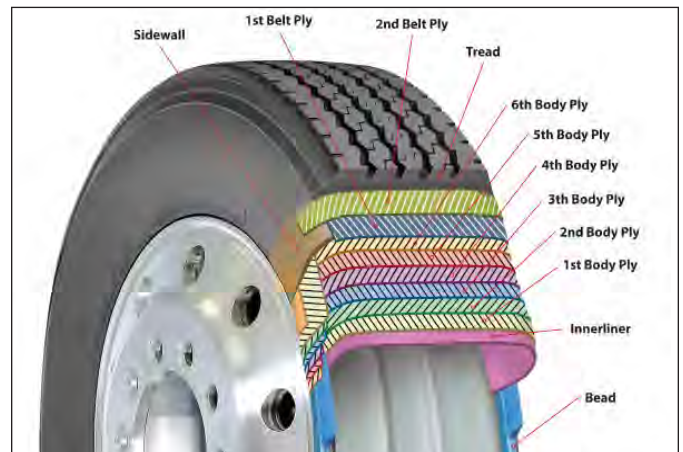
## Tire Construction and Terminology

Most truck tires are of radial ply construction. Radial ply construction provides sidewall flexibility with steel body cords that run across the tire nearly perpendicular to the beads. Radial truck tires have several belt plies with steel cords laid diagonally under the tread to stabilize and reinforce the tread area during contact with the road. See Figure 1.

Bias truck tires consist of multi-layered and adjacent body ply cords that run in alternate diagonal directions from bead to bead at angles substantially less than 90 degrees to the centerline of the tread. The tires may also have belt plies under the tread with cords that lie in approximately the same direction as the body ply cords. Typically the body ply and belt ply cords are nylon. See Figure 2.



**FIGURE 1: Radial Truck Tire Cutaway**



**FIGURE 2: Bias Truck Tire Cutaway**

**Rubber Compounding** - Rubber compounding is a complex science of mixing different raw materials together to produce rubber compounds with specific characteristics. Rubber compounds differ due to their location and functional purpose in the tire. Example: Outside tread compound provides traction and tread wear characteristics. Although rubber is the main material used for making tires, there are a number of other materials used as well. These materials are combined with specific rubber compounds in the different components that make up the tire's construction.

**Bead** - Tire bead bundles (usually strands of wire) secure the tire to the wheel.

**Belts** - Typically, radial truck tires have a number of steel belts with steel cords laid at opposing angles. Bias truck tires may also have fabric belt plies. Belts provide stability to the tread area of the tire, which contributes to wear, handling and traction.

**Body Ply** - Most radial truck tires have one body ply comprised of multiple, flexible strands of steel wire twisted together to make a steel cord. Bias truck tires will have multiple layers of diagonal body plies. The body ply functions as the structure of the tire and provides the strength to contain the inflation pressure.

**Innerliner** - A rubber compound used to retain the inflation pressure inside the tire.

**Sidewall** - A rubber compound used to cover the body ply on the sides of the tire, which provides abrasion, scuff and weathering resistance.

**Tread** - The tread rubber compound and tread pattern provide grip and abrasion resistance contributing to traction and tread wear.

## Tire Size Designations

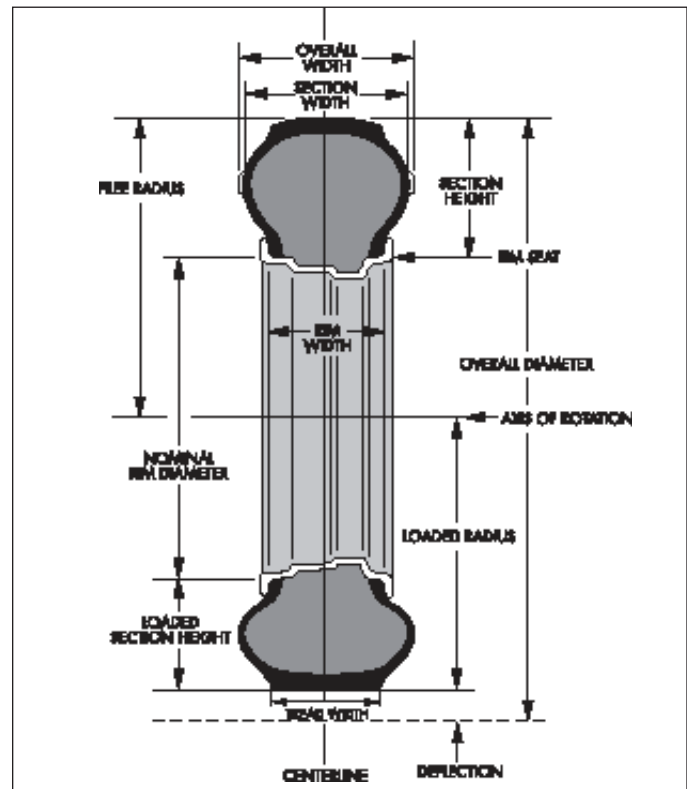
**Section Height** - The height of a new tire from the nominal rim diameter to the top of the tread

**Section Width** - The width of a new tire including normal sidewalls, but not including protective side ribs, bars, or other decorations

**Overall Diameter** - Twice the section height (unloaded) plus the nominal rim diameter

**Rim Width** - The measurement on the inside of the rim between the two flanges

**Rim Diameter Code** - The nominal rim diameter in inches



**FIGURE 3: Cross Section of a Tire and Rim**

**Tire size suffix identification for type of service and proper rim contour** – Suffix letters are included, when necessary, as part of tire size designations to differentiate between tires for service conditions which may require different loads and inflations and/or tires, which must be used on different type rims. Refer to the tire manufacturer for product-specific information. Examples: 7.50-15NHS, 7.50-15TR.

- TR – Tires for service on trucks, buses or other heavy vehicles. This suffix is intended to differentiate between truck tires and light vehicle tires with similar size designations
- ML – Mining and Logging tires used in intermittent highway service
- MH – Tires for Mobile Homes
- HC – Identifies a 17.5 rim diameter code tire for use on low platform trailers
- NHS – Not for Highway Service

Size designation systems presently in use for truck tires are metric and conventional:

### Metric Size Designated Tires

295/75R22.5		Load Range G	144/141L			
295	75	R	22.5	G	144/141	L
Nominal Section Width (mm)	Nominal Aspect Ratio	Construction Code "R" – Radial "D" – Diagonal	Rim Diameter Code	Load Range	Load Index (Single/Dual)	Speed Symbol

445/50R22.5		Load Range L	161L			
445	50	R	22.5	L	161	L
Nominal Section Width (mm)	Nominal Aspect Ratio	Construction Code "R" – Radial "D" – Diagonal	Rim Diameter Code	Load Range	Load Index (Single)	Speed Symbol

## Conventional Size Designated Tires

10.00R20 Load Range H 146/143K					
10.00	R	20	H	146/143	K
Nominal Section Width (inches)	Construction Code "R" – Radial "- " – Diagonal	Rim Diameter Code	Load Range	Load Index (Single/Dual)	Speed Symbol

11R22.5 Load Range H 146/143K					
11	R	22.5	H	146/143	K
Nominal Section Width (inches)	Construction Code "R" – Radial "- " – Diagonal	Rim Diameter Code	Load Range	Load Index (Single/Dual)	Speed Symbol

8R17.5HC Load Range F 122/120L						
8	R	17.5	HC	F	122/120	L
Nominal Section Width (inches)	Construction Code "R" – Radial "D" – Diagonal	Rim Diameter Code	For Use on Low Platform Trailers	Load Range	Load Index (Single/Dual)	Speed Symbol

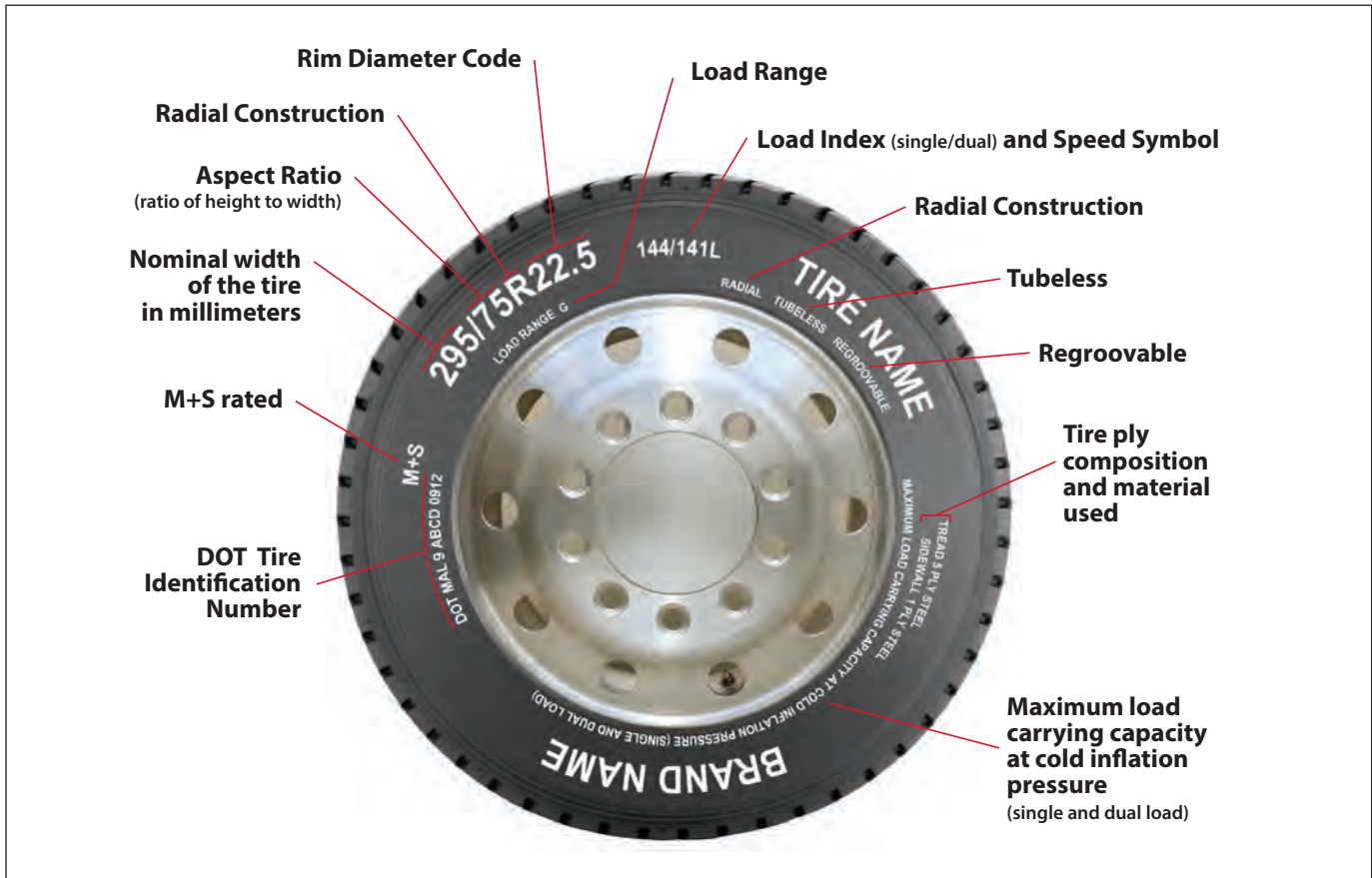
10.00R20ML Load Range F					
10.00	R	20		ML	F
Nominal Section Width (inches)	Construction Code "R" – Radial "- " – Diagonal	Rim Diameter Code	Mining and Logging	Load Range	

11R22.5ML Load Range F					
11	R	22.5		ML	F
Nominal Section Width (inches)	Construction Code "R" – Radial "- " – Diagonal	Rim Diameter Code	Mining and Logging	Load Range	

7R14.5MH Load Range F					
7	R	14.5		MH	F
Nominal Section Width (inches)	Construction Code "R" – Radial "- " – Diagonal	Rim Diameter Code	Mobile Home Tires	Load Range	

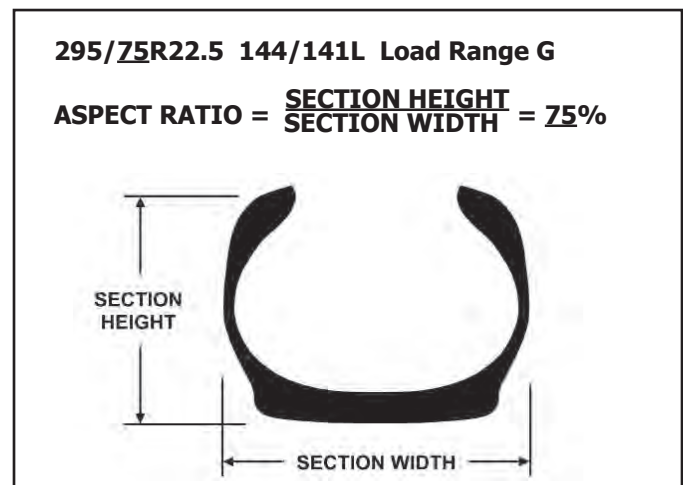
## The Sidewall Story

Tires have very useful information molded onto their sidewall. It shows the brand and model name of the tire, its size, whether it is tubeless or tube type, the maximum load and the corresponding inflation pressure, safety warning(s), and much more. Figure 4 shows typical information on the sidewall of truck tires.



**FIGURE 4: Truck Tire Sidewall Example**

**295/75R22.5** - This marking indicates that the size designation is for a metric size radial truck tire (section width, aspect ratio, construction and rim diameter). An aspect ratio number, typically ranging from 50 to 85 in a truck tire size designation, indicates the ratio of the tire section height to section width. See Figure 5. In the example, a tire with an aspect ratio of 75, the section height of the tire is 75% of the section width. Aspect ratios are also referred to as “series” and “profile” numbers.



**FIGURE 5: Aspect Ratio**



**LOAD RANGE G** - The load range identifies the tire's load and inflation limits. In addition to a load range designation, some tires may also have a ply rating printed on the sidewall, such as "14 Ply Rating." Ply ratings provide a relative indication of the tire's actual load-carrying capacity and do not necessarily indicate the actual number of plies in the sidewall. Current technology with its use of advanced materials typically results in the physical number of plies being less than the ply rating. See Table 1 for typical load range and ply rating values.

Load Range	Ply Rating
F	12
G	14
H	16
J	18
L	20
M	22
N	24

**TABLE 1: Load Range and Ply Ratings**

**SERVICE DESCRIPTION** - The service description is distinct and separate from the tire size designation. It consists of one or two (single load/dual load) three-digit numbers called a load index plus a speed symbol. An example of a service description:

144/141L  
 Load Index (Single/Dual) = 144/141  
 Speed Symbol = L

**LOAD INDEX** - The load index is a numerical code (144/141 in the above example) associated with the maximum load a tire can carry at the speed indicated by its speed symbol under specified service conditions. The numeric load index is a code generally ranging from 100 to 171 for truck tires shown in Table 2 that represents the maximum load carrying capacity. In the example, single and dual application load indices are listed. The maximum tire load capacity is also stamped on the lower sidewall of the tire.

Load Index	KG	LBS	Load Index	KG	LBS	Load Index	KG	LBS
100	800	1,765	124	1,600	3,525	148	3,150	6,940
101	825	1,820	125	1,650	3,640	149	3,250	7,160
102	850	1,875	126	1,700	3,750	150	3,350	7,390
103	875	1,930	127	1,750	3,860	151	3,450	7,610
104	900	1,985	128	1,800	3,970	152	3,550	7,830
105	925	2,040	129	1,850	4,080	153	3,650	8,050
106	950	2,095	130	1,900	4,190	154	3,750	8,270
107	975	2,150	131	1,950	4,300	155	3,875	8,540
108	1,000	2,205	132	2,000	4,410	156	4,000	8,820
109	1,030	2,270	133	2,060	4,540	157	4,125	9,090
110	1,060	2,335	134	2,120	4,675	158	4,250	9,370
111	1,090	2,405	135	2,180	4,805	159	4,375	9,650
112	1,120	2,470	136	2,240	4,940	160	4,500	9,920
113	1,150	2,535	137	2,300	5,070	161	4,625	10,200
114	1,180	2,600	138	2,360	5,205	162	4,750	10,500
115	1,215	2,680	139	2,430	5,355	163	4,875	10,700
116	1,250	2,755	140	2,500	5,510	164	5,000	11,000
117	1,285	2,835	141	2,575	5,675	165	5,150	11,400
118	1,320	2,910	142	2,650	5,840	166	5,300	11,700
119	1,360	3,000	143	2,725	6,005	167	5,450	12,000
120	1,400	3,085	144	2,800	6,175	168	5,600	12,300
121	1,450	3,195	145	2,900	6,395	169	5,800	12,800
122	1,500	3,305	146	3,000	6,610	170	6,000	13,200
123	1,550	3,415	147	3,075	6,780	171	6,150	13,600

**TABLE 2: Load Index and Maximum Load Capacity\***

\*The loads in this table are the maximum load capacity for the tire at a certain corresponding inflation pressure. In order to determine actual tire load capacity at different inflation pressures, consult the tire manufacturer for the proper load/inflation tables. Values based on ISO and TRA standards for truck tires.

**SPEED SYMBOL** – The speed symbol is a letter indicating the speed at which a tire can carry a load corresponding to its load index. In the previous example, the speed symbol “L” in the service description corresponds to a speed category of 75 miles per hour (mph). See Table 3 for typical truck tire speed symbols.

SPEED SYMBOL	SPEED CATEGORY*
F	50 mph (80 km/h)
G	55 mph (90 km/h)
J	62 mph (100 km/h)
K	68 mph (110 km/h)
L	75 mph (120 km/h)
M	81 mph (130 km/h)
N	87 mph (140 km/h)

\* In laboratory testing that relates to highway speeds. Actual tire speed and performance capability depend on factors such as inflation pressure, load, tire condition, wear and driving conditions.

**TABLE 3: Speed Symbols**

**MAXIMUM LOAD CARRYING CAPACITY AT COLD INFLATION PRESSURE** – If the tire size is one that can be used as either a single application (such as on the steering axle) or as a dual application (such as on a drive

or trailer axle), a maximum load and corresponding cold inflation will be stated for each application. In the example of a 295/75R22.5 Load Range G tire with a 144/141L service description, it would list:

MAX LOAD SINGLE 2800 kg (6175 lbs.) AT 760 kPa (110 psi) COLD indicates the maximum load of the tire and corresponding cold inflation pressure for that load when used as a single. Sidewall markings are given in both metric and English units. Follow tire inflation pressure recommendations based on actual loads carried by the individual tires. Using the load and inflation charts in the tire manufacturer’s data book or the Tire and Rim Association’s Year Book, the load capacity at the required cold pressure for a single tire or for each tire of a dual assembly can be determined. See Chapter 2, “Proper Tire Inflation.”

MAX LOAD DUAL 2575 kg (5675 lbs.) AT 760 kPa (110 psi) COLD indicates the maximum load of the tire and corresponding cold inflation pressure for that load when used in a dual configuration. Sidewall markings are given in both metric and English units. Follow tire inflation pressure recommendations based on actual loads carried by the individual tires. Using the load and inflation charts in the tire manufacturer’s data book or the Tire and Rim Association’s Year Book, the load capacity at the required cold pressure for a single tire or for each tire of a dual assembly can be determined. See Chapter 2, “Proper Tire Inflation.”

TIN Regulation Effective Date	DOT Symbol	Mfr. ID / Plant Code	Tire Size Code	Mfr. Tire Type / Descriptive Code	Week	Year	Date of Manufacture “Date Code” Examples
Original Regulation	DOT	XX	XX	XXXX	XX	X	025      2 <sup>nd</sup> week of 1995 <small>(week 01, 1995 to 1999)</small>
July 2, 2000	DOT	XX	XX	XXXX	XX	XX	0908      9 <sup>th</sup> week of 2008
April 13, 2015	DOT	XX	XX	XXXX	XX	XX	4815      48 <sup>th</sup> week of 2015
either type of TIN is permissible	DOT	XXX	XXXXXX		XX	XX	3218      32 <sup>nd</sup> week of 2018
April 13, 2025	DOT	XXX	XXXXXX		XX	XX	2325      23 <sup>rd</sup> week of 2025

**FIGURE 6: DOT TIN Description**

**RADIAL** - A tire with a radial construction must show the word "RADIAL" on the sidewall. A radial tire is also delineated by the character "R" in the size designation.

**PLIES/FABRIC INFORMATION** - The ply/fabric information identifies the number of plies and type of cord materials in the tire tread and sidewall areas. A bias ply tire typically has multiple plies in the sidewall (versus an all-steel radial tire, which generally has a single sidewall ply).

**DOT TIRE IDENTIFICATION NUMBER** - The "DOT" symbol certifies the tire manufacturer's compliance with U.S. Department of Transportation (DOT) tire safety performance standards. Next to these letters is the tire identification number (TIN) - also known as the tire "serial" number.

Over the years and in the future, the TIN found on a tire may be different. See Figure 6 on p. 6 for an explanation of the various formats used, including examples interpreting the date code. See Chapter 4, "Repair, Retread and Regrooving" for a retreaded tire TIN explanation.

## NOTE

The DOT TIN is necessary to register a tire with the manufacturer for purposes of warranty and recall communication. See "Tire Registration and Recall Information" on p. 8.

**TUBELESS** - The tire must be marked either "tubeless" or "tube type."



**MOUNTAIN SNOWFLAKE SYMBOL with M+S** - Some truck/bus tires may be marked with the three peak mountain snowflake symbol and the letters "M+S". (Other formats include: "MS", "M/S", or "M&S".) Together, these markings indicate that the tire meets the USTMA definition for truck/bus tires for use in severe snow conditions. Refer to USTMA Tire Information Service Bulletin, Vol. 50, "USTMA Definition for Truck and Bus Tires for Use in Severe Snow Conditions."

**REGROOVABLE** - Some truck tires may be marked as "Regroovable." A tire that is marked as regroovable indicates the original tread (not the retread) of the tire is designed and constructed with sufficient material to permit renewal of the tread pattern, or the generation of a new tread pattern in a manner which conforms to federal regulations. For more information on regulations that apply specifically to regrooved or regroovable tires, see U.S. Code of Federal Regulations: Title 49, Transportation; Parts 569 and 393.75; also see Chapter 4, "Repair, Retread and Regrooving."

## Types of Tread Design

A variety of truck tire tread patterns are available for enhanced service in different applications. Some common types are shown in Figures 7, 8 and 9. Consult the tire manufacturer for application recommendations.

**Rib-Type Tread** - Rib-type tread tires are typically "all position" tires, unless otherwise designated. The circumferential groove design optimizes steering, traction and tread wear at different wheel positions.



**FIGURE 7:  
RIB-TYPE TREAD**



**FIGURE 8:  
LUG-TYPE TREAD**



**FIGURE 9:  
COMBINATION RIB/  
LUG-TYPE TREAD**

**Lug-Type Tread** - Also referred to as cross lug-type tread tires, they are usually designed for drive wheel service and special service/off-road applications. The tread on these tires is normally deeper and more “open” for higher traction in conditions such as on unimproved surfaces and in mud/snow.

**Combination Rib/Lug-Type Tread** - Tires with tread patterns that have a combination of rib and lug designs are usually intended for on- and/or off-road service. These tires optimize wear and traction in a variety of service conditions. They normally wear better than lug-type tires on drive wheel positions.

## **Tire Registration and Recall Information**

Registration of tires is an important step to complete when placing them into service. Registration enables manufacturers to contact the consumer in the event of a recall.

At the point of sale, consumers should be provided a tire registration card. This information should be completed and submitted as soon as possible. USTMA tire manufacturer members also provide online tire registration forms that can be submitted electronically.

Consumer contact information and DOT Tire Identification Numbers (TIN) are necessary for registration. In addition, DOT TINs are necessary to determine whether a tire is subject to a recall.

Visit [www.USTires.org](http://www.USTires.org) for links to USTMA member tire registration websites and for a tire recall look up tool.

## Overview

### THE MOST IMPORTANT FACTORS IN TIRE SAFETY, PERFORMANCE AND SERVICE LIFE ARE:

- PROPER TIRE SIZE, TYPE, AND LOAD CAPACITY (OR LOAD RANGE)
- PROPER INFLATION PRESSURE
- PROPER VEHICLE LOADING
- REGULAR TIRE ROTATION
- REGULAR INSPECTION
- PROPER TIRE REPAIR AND RETREADING
- VEHICLE CONDITION, ALIGNMENT AND MAINTENANCE
- GOOD DRIVING HABITS

Tires are designed and manufactured with advanced technology and great care to provide thousands of miles of excellent service. For maximum safety, performance and service life, they must be maintained properly.

This chapter will continue to address these and other factors relative to the care and service of truck and bus tires.

### Proper Tire Inflation

Tire inflation pressure is typically measured in pounds per square inch (psi). Under inflation causes excessive heat build-up and internal structural damage that may lead to a tire failure, including tread/belt separation, even at a later date. The pressure marked on the sidewall that corresponds to the maximum load of the tire is typically the maximum pressure recommended by the tire manufacturer for that tire. Do not exceed the inflation pressure shown on the tire sidewall without first contacting the tire and rim/wheel manufacturer. Over inflated tires are more likely to be cut, punctured or damaged by sudden impact from hitting an obstacle, such as a pothole.

Establishing inflation pressures for optimum vehicle and truck tire performance is complex since it takes into account many different variables, including the following:

- Type of tire, including size, load capacity, and speed capability
- Intended application
- Axle loads, including GAWR and actual loads
- Service conditions
- Wheel size and pressure rating
- Tread wear
- Fuel economy
- Vehicle dynamics

Manufacturers of trucks and buses specify tire inflation pressure for each axle on the vehicle tire placard, certification label or in the service manual. Certification labels are affixed to the vehicle in locations that depend on the vehicle type.

These areas include: driver's door, hinge pillar or seating area; near the instrument panel; or other access doors near the driver. For examples, see Figures 10, 11, 12, and 13 on p. 10.

The certification label contains the following important information:

- Tire size
- Cold tire inflation pressures
- Wheel size
- Gross Axle Weight Rating (GAWR) for each axle
- Gross Vehicle Weight Rating (GVWR)

Use of the tires, wheels, and inflation pressures as specified on the vehicle tire placard, certification label or in the service manual ensures that these components can carry the maximum rated axle loads (GAWR) and maximum vehicle weight (GVWR), and also maintains other performance characteristics, if any, intended by the vehicle manufacturer. At a minimum, the tires on each axle should not be over loaded or under inflated if the vehicle is properly loaded.

An alternate tire, wheel, or inflation pressure specification that optimizes performance for different tire types, applications, or service conditions could be recommended, particularly in the following circumstances:

- If actual operating conditions differ from the maximum capacity (GAWR and/or GVWR) of the vehicle
- If there has been a change to the size or load/pressure capacity of either the tire or the wheel
- If the vehicle is used in a unique or special service application
- If the component, such as the tire, has been optimized for a given application

For assistance with determining proper inflation pressure, contact a tire service professional, vehicle manufacturer or tire manufacturer.

## ⚠ WARNING

Driving on tires with improper inflation pressure is dangerous.

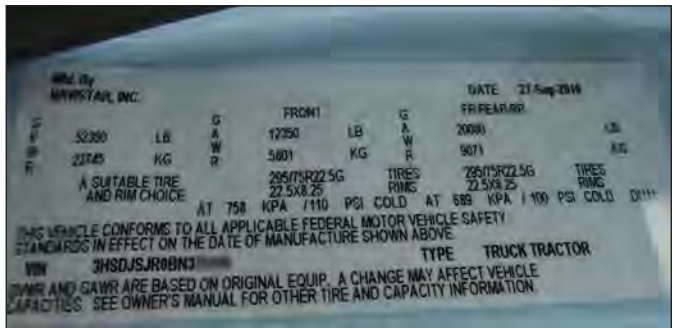
- Under inflation causes excessive heat buildup and internal structural damage.
- Over inflation makes it more likely for tires to be cut, punctured or broken by sudden impact.

These situations can cause a tire failure, including tread/belt separation, even at a later date, which could lead to an accident and serious personal injury or death.

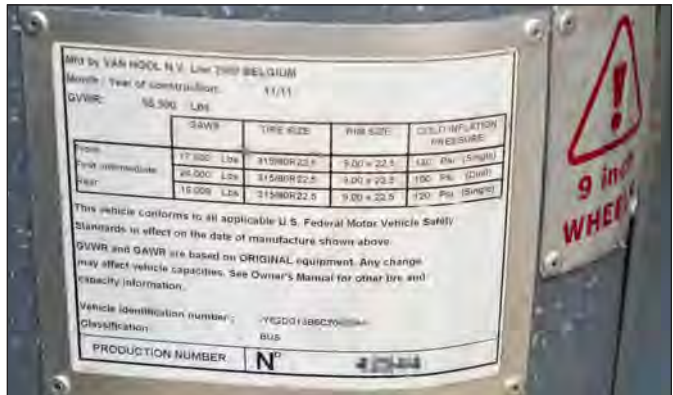
Consult the vehicle tire placard, certification label or the service manual for the recommended inflation pressures.



**FIGURE 11: Truck Certification Label**



**FIGURE 12: Truck Certification Label**



**FIGURE 13: Bus Certification Label**



**FIGURE 10: Trailer Certification Label**

### NOTE

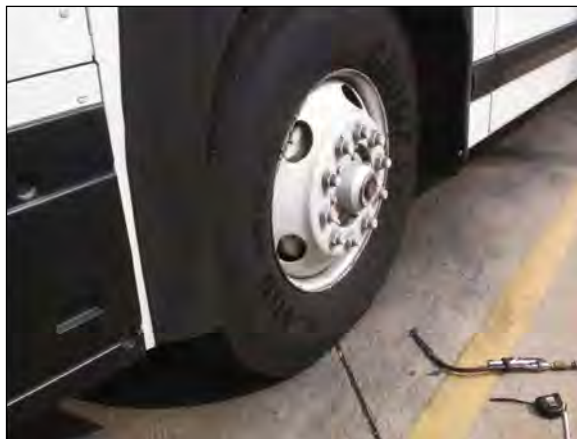
The pressure indicated on the tire sidewall is typically the maximum allowed in the tire, irrespective of the vehicle. Do not exceed the inflation pressure shown on the tire sidewall without first contacting the tire and rim/wheel manufacturer.

One of the tires in Figures 14 or 15 is dangerously under inflated. You cannot tell just by looking at or striking the tire. Check inflation pressure with an accurate tire gauge. A dual foot gauge calibrated in 2 psi increments up to 150 psi is sufficient. Even if it is difficult to check the inflation pressures of inside tires in dual fitments, it is imperative that these inflation pressures be checked and properly maintained because the inside dual tires are subjected to more severe operating conditions, such as:

- High heat exposure, due to close proximity to brakes
- Lower air circulation to assist in cooling
- Crowned road surfaces (which can cause inside dual tires to support more of the load than the outside dual tires)



**FIGURE 14: Properly Inflated**



**FIGURE 15: 50% Under Inflated**

**When to Check Inflation Pressure** - Maintaining proper inflation pressure maximizes fuel economy and optimizes overall tire performance. Check inflation pressure when tires are cold, that is, when the vehicle has been parked for at least three hours or has been driven less than one mile at moderate speed. The inflation pressure in all tires, including the spare tire and inside duals, should be checked with an accurate tire gauge frequently, such as daily during continuous service, pre-trip inspections, and at preventative maintenance intervals. This includes vehicles equipped with a Tire Pressure Monitoring System (TPMS).

Never “bleed” or reduce inflation pressure when tires are hot from driving, as it is normal for pressures to increase above recommended cold pressures. If a hot tire pressure reading is at or below recommended cold inflation pressure it may be dangerously under inflated. In this case, immediately determine the cause and/or have the tire checked by a tire service professional.

Truck tires may lose 2 to 4 psi inflation pressure per month under normal conditions and 2 to 4 psi for every 10°F of temperature drop. If a truck tire continually loses more than 4 psi inflation pressure per month, have it checked by a tire service professional.

Significant changes in altitude or temperature at which a vehicle will regularly operate will result in changes in inflation pressure and will require an inflation pressure check and adjustment.

When a new vehicle or a newly purchased used vehicle is being placed into service for the first time, the inflation pressure should be properly adjusted for the type of service. See Chapter 3, “Tire Application and Replacement Guidelines” on p. 33.

**Inflating Truck/Bus Tires** - Never inflate a tire unless it is secured to a vehicle, tire mounting machine or other restraining device such as a safety cage. Use a remote inflation device with a clip-on chuck standing away from the tire as shown in Figures 16, 17 and 18 on p. 12. When mounting a tire to a rim/wheel, see Chapter 5, “Demounting and Mounting Procedures Including Multi-Piece Rim Matching” on p. 53.

**Continuous Inflation Pressure Loss** - Any tire that continually requires reinflation is a serious safety risk. The cause may be the result of a puncture, road hazard damage, leaking valve, tire mounting damage, or other irregular condition. Continuous use of a tire in an under inflated condition will result in heat build-up and internal tire damage. This may result in a tire failure, including tread/belt separation. Tires that continuously require reinflation should be inspected thoroughly by a tire service professional and be properly serviced or replaced immediately.

**Tires Run at 80% or Less of Normal Pressure** - Permanent tire damage due to under inflated operation cannot always be visibly detected. Any truck tire known or suspected to have run at 80% or less of normal operating inflation pressure could possibly have permanent structural damage and should be considered to be a flat tire. The tire should be demounted using proper precautions and should not be reinflated until the tire is carefully inspected by a tire service professional for determination of the cause of the under inflation. See Inspection Procedures to Identify Potential Sidewall "Zipper Ruptures" in Steel Cord Radial Truck, Bus and Light Truck Tires on p. 18.

**Dual Tire Assemblies** - For vehicles equipped with dual tire assemblies (duals), if one of the dual tires becomes significantly under inflated or flat, the other tire will carry the load for both tires, resulting in an over loaded condition. Both tires should be inspected by a tire service professional for damage.

**Tire Pressure Monitoring Systems (TPMS)** - It is still important to check inflation pressure frequently with a calibrated tire gauge even on vehicles that are equipped with a TPMS. TPMS are designed to be beneficial and accurate. However, they should not be solely relied on for inflation pressure maintenance since some systems may have limitations such as lack of a timely warning of low inflation pressure or a flat tire condition. Under inflation (prior to a TPMS warning) is increasingly dangerous at high speeds, heavy vehicle loads, extended distances and at high ambient temperatures.

**Automatic Tire Inflation Systems (ATIS)** - These are designed to maintain tire inflation pressure using an on-board, regulated air supply connected to the tire valves. ATIS can help compensate for normal inflation pressure loss and inflation pressure changes due to temperature in a tire. Use of ATIS is not a replacement for regular inflation pressure checks and tire inspections.

**Valve Caps** - Always cover the valve stem with a metal, high-temperature sealing cap. This helps prevent moisture, dirt and other contaminants from entering the valve core, as well as providing an additional seal.



**FIGURE 16: Inflating in the Shop**



**FIGURE 17: Inflating in Portable Safety Cage**



**FIGURE 18: Inflating on the Vehicle**

**Inflation Pressure for Off-Road Use** - Inflation pressures for tires used in most off-road situations should be the same as those for highway driving. If a lower inflation pressure is used to gain additional flotation/traction at low speeds, the tires must be reinflated before resuming driving on the highway or at higher speeds, whether on- or off-road.

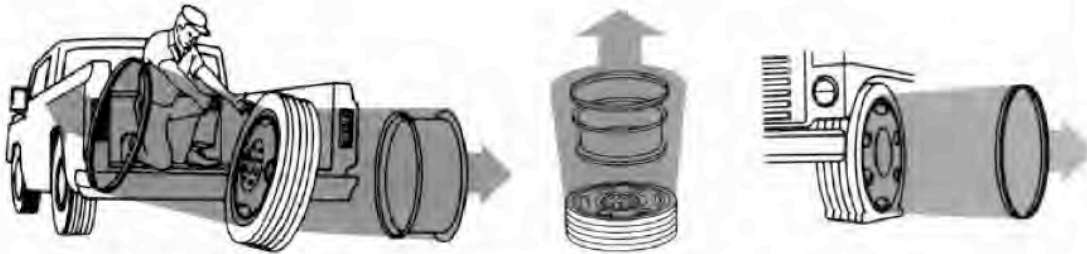


## **⚠ WARNING**

Inflating an unsecured tire is dangerous. If it bursts, it could be hurled into the air with explosive force resulting in serious personal injury or death. Never inflate a tire unless it is secured to a vehicle, tire mounting machine or other restraining device such as a safety cage.

Completely deflate the tire by removing the valve core before removing the wheel/tire from the axle if there is known or suspected damage to the tire or wheel or if the tire has been run at 80% or less of its recommended pressure. Demount, inspect and match all the tire and rim parts before reinflating.

Stay out of the trajectory as indicated by shaded area. Under some circumstances the trajectory may deviate from its expected path. Always deflate tires before handling. Inflate only in a safety cage.



**Using Nitrogen Inflation** - Nitrogen may be offered as an alternative to air for tire inflation. Nitrogen is an inert (non-flammable) gas - basically, nothing more than dry air with oxygen removed (air contains about 78% nitrogen). Because of its inert properties, nitrogen is often used in highly specialized service applications and/or demanding environments. For instance, aircraft, mining and commercial/heavy applications use nitrogen to help reduce the risk of internal combustion (fire) if the brake/rim/wheel components overheat. Also, dry nitrogen is used in professional racing to help reduce variation in inflation pressures (caused by moisture) where even small differences in pressure can affect vehicle handling at the extreme limits of performance.

For normal tire service applications, nitrogen inflation is not necessary. However, nitrogen inflation is permissible as its properties may contribute to minor reductions in inflation pressure loss. Nevertheless, several other sources of pressure leaks, such as punctures, tire/rim interface (bead), valve, valve/rim interface, and the wheel, may negate the benefit of nitrogen. If the tire inflation pressure is below the pressure specified on the vehicle tire placard, certification label or service manual, the tire must be reinflated either with air or nitrogen to the proper inflation pressure. Do not operate tires under inflated and/or over loaded.

Depending on nitrogen alone to reduce the requirements for inflation maintenance may lead to under inflated operation that may result in premature tire failure. With the right amount of inflation pressure, you will achieve optimum tire performance. This means your tires will wear longer, consume less fuel and help prevent accidents. Nitrogen and

air can be mixed in any and all proportions. Nitrogen filled tires can and should have air added whenever nitrogen is not readily available to maintain proper inflation as specified by the vehicle manufacturer. For information on storing and handling nitrogen, follow the manufacturer's and/or supplier's safety guidelines.

### **NOTE**

Whether inflated with air or nitrogen, regular inflation pressure maintenance remains critical and necessary. Use of nitrogen alone is not a replacement for regular inflation pressure maintenance.

### **Tire Loading**

To avoid over loading tires, maintain the proper inflation pressure and never exceed the vehicle's load capacity, Gross Axle Weight Rating (GAWR) or the Gross Vehicle Weight Rating (GVWR) stated on the vehicle tire placard, certification label or the vehicle service manual. The vehicle load must also be distributed so that no individual axle, tire or dual assembly is over loaded.

The maximum load for each tire is molded on the tire sidewall (along with the cold inflation pressure for that load). Never exceed the load or inflation pressure limits of the tire, rim or wheel assembly.

Consult the vehicle owner's manual or service manual for load recommendations and special instructions (such as the use of tag axles).

## Sudden Ride Disturbance or Vibration

If the vehicle experiences a sudden vibration or ride disturbance and/or there is a possibility the tires and/or vehicle have been damaged, gradually reduce speed. Do not abruptly brake or turn. Drive with caution until you can safely pull off the road. Stop and inspect the tire. If the tire is under inflated or damaged, have the tire inspected and repaired or replaced by a tire service professional. If a cause cannot be detected, the vehicle should be towed to the nearest vehicle or tire dealer for an inspection.

## Tire Inspection Guidelines

In addition to maintaining inflation, regularly inspect the tire tread and sidewalls for irregular tread wear, cracking, scrapes, bulges, cuts, snags, foreign objects or other damage resulting from use. It is recommended that tires, including the spare, be periodically inspected by a tire service professional during routine preventative maintenance intervals.

Remove any stones, glass, foreign objects, etc. embedded in the tread to prevent damage. Even minor damage can lead to further injury and eventual tire failure. Also, it is a good practice to check between dual tire/wheel assemblies for foreign objects, like large rocks, that may have become lodged between the tires, especially after off-road service.

Tires with excessive cracking on the tread or sidewall(s) should be removed from service. This is typically caused by under inflation, over loading, improper storage, and/or improper long-term parking.

Replace tires when worn to 2/32" (1.6 mm) tread depth remaining anywhere on the tread face. For vehicles with a GVWR in excess of 10,000 pounds (4,536 kg), federal regulations state that tires on the front axle should be removed when worn to 4/32" (3.2 mm) tread depth. Refer to Code of Federal Regulations: 49 CFR 570.62 and 49 CFR 393.75(b).

Built-in tread wear indicators or "wear bars," which look like narrow strips of smooth rubber across the tread, will appear on the tire when the tread is worn to 2/32" (1.6 mm). See Figure 19. When a tread wear indicator is flush with the tread surface, the tire is worn out and should be removed from service.

Drivers should check their tire tread and sidewall areas frequently with inflation checks, looking for uneven or irregular tread wear, cuts, cracks, scrapes, snags, bulges, foreign objects or other damage.



**FIGURE 19: Tread Wear Indicators**

There are manuals published by the Technology and Maintenance Council of the American Trucking Associations (TMC-ATA) that may be used by service facilities, truck stops, tire dealers, state motor vehicle inspection stations, etc., as a reference for inspection of tires, rims, and wheels:

- "Radial Tire Conditions Analysis Guide"
- "Radial Tire & Disc Wheel Service Manual"
- "Users Guide to Wheels and Rims"

### **⚠WARNING**

Driving on damaged tires is dangerous. A damaged tire can suddenly fail leading to situations that may result in serious personal injury or death. Tires should be regularly inspected by a qualified tire service professional.

**Reasons for Tire, Rim/Wheel or Valve Removal** - If any of the conditions below are found when inspecting a tire, rim/wheel or valve, the item should be removed from service. (Note: This list is not all-inclusive.)

#### **Tread Conditions**

- For Drive and Trailer Axle Positions: Worn to 2/32" (1.6 mm) or less anywhere on the face of the tread and/or worn to any tread wear indicators
- For Front Steer Axle Positions: Worn to 4/32" (3.2 mm) for front axle positions or less anywhere on the face of the tread
- Localized spot wear due to separation or retread edge lift
- Cuts, cracks, bulges, or snags in the tread or groove exposing cord or fabric material (excludes repairable conditions)
- Unrepairable punctures

#### **Sidewall Conditions**

- Impact break (e.g. rim bruise break)
- Bulges, blisters or deep cuts/cracks
- Excessive sidewall abrasion
- Exposed cords or fabric material

#### **Bead Conditions**

- Sharply bent or broken beads or bead wires
- Deep cuts/cracks
- Torn bead area rubber
- Excessive rim flange grooving or severely chafed bead area rubber

#### **Innerliner Conditions**

- Exposed body ply cords
- Unrepairable punctures
- Previous improper repairs
- Foreign object damage
- Cracking with visible cord material
- Run flat damage as exhibited by abrasions, cracking, blisters, wrinkles, discoloration, or breakdown of cord material

#### **Rim/Wheel or Valve Conditions**

- Any rim/wheel that is bent, dented, cracked, excessively corroded or otherwise damaged
- Damaged valve and/or valve core

**Common Types of Tire Damage** - Several types of tire damage are covered in this section. However, it is not all-inclusive and should only be used as a general guideline for identifying a variety of damage conditions. See Figure 20 on p. 17 for common examples of tire damage.

### **⚠ WARNING**

Under inflation and/or over loading of a tire causes excessive heat build-up and internal structural damage. This may cause a tire failure, including tread/belt separation, even at a later date, which can lead to an accident and serious personal injury or death.

Over loading a vehicle can have other serious safety consequences such as suspension or wheel failure, increased braking distance or brake failure (particularly on steep grades), and adverse vehicle handling/stability.

Consult the vehicle tire placard, certification label and service manual for the recommended vehicle load limits and tire inflation pressures.

#### **Under Inflation and/or Over Loading Damage**

Under inflation and/or over loading is the leading cause of tire failure, so it is important to maintain inflation pressure and to properly load the vehicle. See "Proper Tire Inflation" on p. 9 and "Tire Loading" on p. 13.

Under inflation and/or over loading of a tire causes excessive heat build-up and internal structural damage. This may cause a tire failure, including tread/belt separation, even at a later date, which can lead to an accident and serious personal injury or death.

It is important to inspect tires for under inflation and/or over loading damage such as internal tire separation, heat discoloration, cracking, rim flange grooving, and localized accelerated tread wear (spot wear).

Any truck tire known or suspected to have run at 80% or less of normal operating inflation pressure could possibly have permanent structural damage and should be considered to be a flat tire. The tire should be demounted using proper precautions and should not be reinflated until the tire is carefully inspected by a tire service professional for determination of the cause of the under inflation. See "Inspection Procedures to Identify Potential Sidewall 'Zipper Ruptures' in Steel Cord Radial Truck, Bus and Light Truck Tires" on p. 18.

### **Road Hazard Damage**

Punctures, cuts, snags, etc., can lead to further damage if not repaired in time. The tire must be demounted and carefully inspected to determine whether it is repairable. Some road hazard damage may result in gradual inflation pressure loss. If not corrected as soon as possible, such damage can ruin tires that could otherwise have been repaired. See "Proper Tire Repair" on p. 40.

### **Impact Damage**

Impact damage to the tire may initially show little or no exterior evidence. However, internal damage can progress with additional mileage and eventually cause internal tire separation, detachment or sudden loss of inflation. Impact damage may cause gradual inflation pressure loss. After experiencing an unusual impact, have the tire inspected by a tire service professional.

A rim bruise break (pinch shock) occurs when the tire strikes a rigid object (like a curb or pothole) hard enough to crush the tire's sidewall between the rim flange and the rigid object. Vehicles operated off-road or in areas away from paved roads can encounter many objects that may cause tire damage. Careful inspection of the tires should be made after use in off-road service.

### **Demounting or Mounting Damage**

Tires that have been damaged by improper demounting/mounting procedures may fail prematurely. For instance, a torn bead may cause gradual inflation pressure loss and even lead to internal tire separation. See Chapter 5, "Demounting and Mounting Procedures Including Multi-Piece Rim Matching" on p. 53 for proper mounting and demounting procedures and multi-piece rim matching information.

### **Ozone Cracking or Weather Checking**

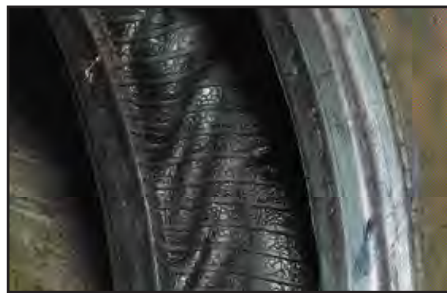
Weather checking/ozone cracking can occur during direct and extended exposure to damaging effects of the environment, such as ozone and heat from sunlight. Ozone cracking can also be caused by exposure to electric motors, welding equipment, or other ozone generating sources. Ozone levels should not exceed 0.08 parts per million (ppm).

Remove from service tires with severe weather checking/ozone cracking or any cracking extending to the tire casing cords/plies. See "Tire Storage Recommendations" on p. 29.

Treating tires with incompatible dressings or harsh cleaning agents will hasten oxidation and result in premature cracking. Always avoid petroleum-based tire dressings/cleaners. Check the tire manufacturer recommendations for cleaning tires. See "Cleaning Tires" on p. 30.



RUN FLAT



RUN FLAT



ZIPPER RUPTURE



PUNCTURE



TREAD/BELT SEPARATION



TREAD/BELT SEPARATION



IMPROPER REPAIR (PLUG ONLY)



REINFORCE/CHAFER SEPARATION



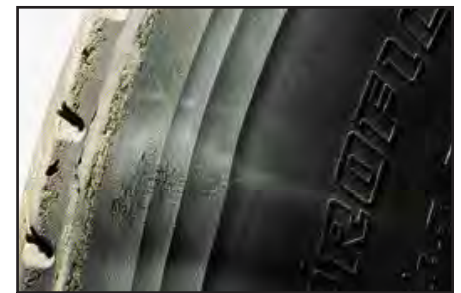
SIDEWALL SNAG



TORN BEAD



OZONE WEATHER CRACKING



BULGE



BURNED BEAD



CROWN IMPACT BREAK



CROWN IMPACT BREAK

FIGURE 20: COMMON EXAMPLES OF TIRE DAMAGE

(Some images courtesy of The Technology & Maintenance Council of the American Trucking Associations.)

## Inspection Procedures to Identify Potential Sidewall “Zipper Ruptures” in Steel Cord Radial Truck, Bus and Light Truck Tires

The purpose of this section is to describe the inspection procedures for identifying potential sidewall circumferential ruptures (also known as “zipper ruptures”) on truck/bus tires and light truck tires of steel cord radial construction. Also see USTMA wall chart, “Inspection Procedures to Identify Potential Sidewall ‘Zipper Ruptures’ in Steel Cord Radial Truck, Bus and Light Truck Tires.”

Figure 21 is an example of a zipper rupture in a truck tire casing. Note the characteristic “zipper-like” seam running along the sidewall where the rupture occurred.



**FIGURE 21: Example of a Zipper Rupture**

### **⚠WARNING**

Tire and rim servicing can be dangerous and must only be performed by trained personnel using proper procedures and tools. See Chapter 5, “Demounting and Mounting Procedures Including Multi-Piece Rim Matching” on p. 53. Failure to follow these procedures may result in serious injury or death.

### **⚠WARNING**

Any tire suspected of operating under inflated and/or over loaded must be approached with caution. Permanent damage due to operating a tire under inflated and/or over loaded cannot always be detected. Any tire known or suspected of being operated at 80 percent or less of normal operating inflation pressure and/or over loaded could possibly have permanent sidewall structural damage (steel cord fatigue).

Ply cords weakened by under inflation and/or over loading may break one after another, until a rupture occurs in the upper sidewall with accompanying instantaneous air loss and explosive force. This can result in serious injury or death.



### **Step 1 — Inspect Tire “Suspect” Tires**

When a vehicle equipped with Steel cord radial truck/bus tires or light truck tires is suspected of operating with one or more tires under inflated and/or over loaded, approach such tires with caution. A tire service professional must remove the valve core and completely deflate the tire before removing the tire/rim/wheel assembly from the vehicle. After it is removed from the vehicle, the tire service professional should demount the tire from the rim/wheel and conduct a complete visual and hands-on inspection of the tire.

For tires that have already been demounted and are being prepared to be repaired/retreaded, the same inspection procedure applies. If available, the tire service professional could also utilize non-destructive inspection equipment, such as shearography, x-ray, or other non-destructive testing, to look for any anomalies present in the casing. For all tires returning to service, a tire service professional should conduct a complete visual and hands-on inspection of the tire in a well-lighted area and with a hand-held grazing light. See Figures 22, 23 and 24.

#### **Look For:**

- Punctures or other injuries
- Distortions or undulations (ripples and/or bulges) in the sidewall
- Cuts, snags, or chips that expose any body ply cords or steel wire

#### **Feel For:**

- Soft spots in the sidewall flex area
- Distortions or undulations (ripples and/or bulges) in the sidewall
- Protruding wire filaments indicating broken cords

#### **Listen For:**

- Any snapping, popping or crackling sounds

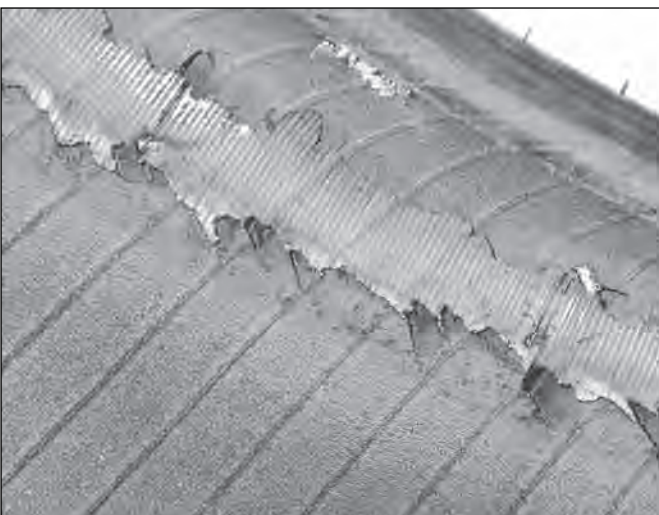
If tires contain punctures, cuts, snags, or chips exposing the body ply cords or steel wire, but does not exhibit any other potential zipper characteristics, it should be referred to a full service repair facility for further inspection to determine if it is a repairable condition and not a source of a potential 'zipper rupture.'

If the tire does exhibit potential zipper rupture characteristics, it must be marked appropriately, made unserviceable and non-repairable and then scrapped!

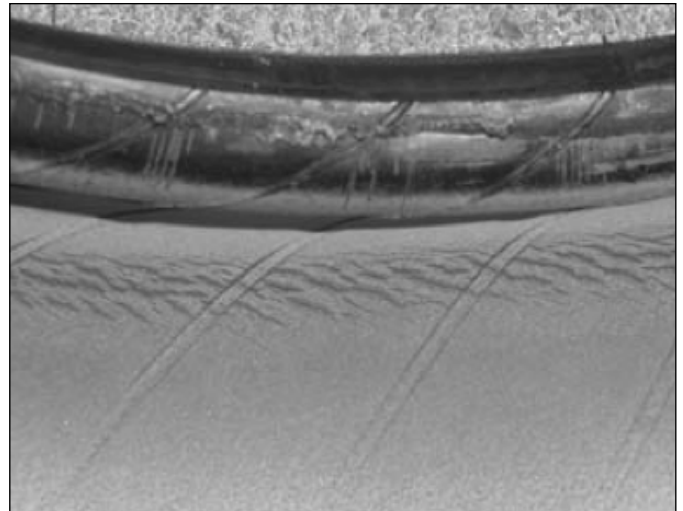
If none of these conditions are present, with the valve core still removed, continue to step 2.



**FIGURE 22: Using a grazing light or other indirect light source will produce shadows which indicate sidewall irregularities and/or signs of possible "zipper rupture."**



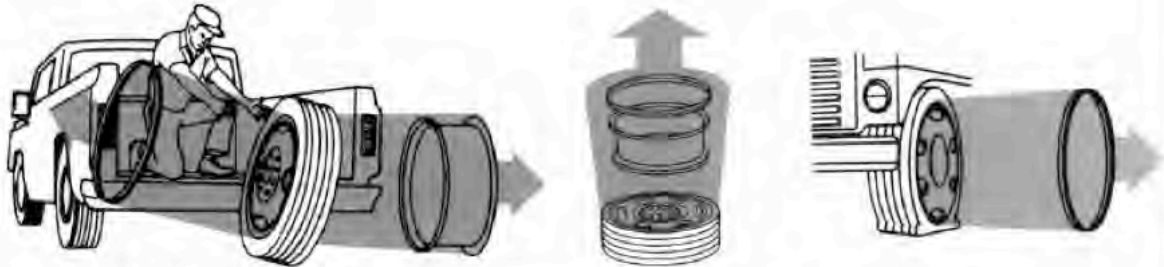
**FIGURE 23: Note the exposed body ply cord on the tire innerliner. This condition is the result of the tire being operated under inflated and/or over loaded.**



**FIGURE 24: Wrinkled and discolored innerliner in the tire's flex area is another sign of being operated under inflated and/or over loaded.**

## ⚠ WARNING

DO NOT place hands or head in or near the restraining device while inspecting and inflating the tire. Even in a restraining device, close proximity to the force of air and/or exploded remnants from a tire rupture could cause serious personal injury or death. ALWAYS remain outside of the tire's trajectory as in the illustrated examples below. NOTE: Under some circumstances, the trajectory may deviate from its expected path.



### Step 2 — Inflate Tire to 20 PSI

#### Proper Initial Inflation

If none of the “zipper rupture” conditions are reset during the initial inspection of the tire in step 1, mount the tire on its rim/wheel assembly and inflate to approximately 5 psi to seal the beads. Place the assembly in an OSHA-approved restraining device, such as a tire safety cage. See Figure 25.

Inflate the tire with the valve core removed, using a clip-on air chuck with a pressure regulator and an extension air hose.

For light truck and medium truck tires inflate the tire up to 20 psi. For tires designed for bus and refuse applications, inflate the tire up to 40 psi.

Throughout initial inflation in Step 2, always

#### Listen For:

- Any snapping, popping or crackling sounds

#### Look For:

- Distortions or undulations (ripples and/or bulges) in the sidewall. See Figure 26 on p. 21.

If any of these conditions are present during inflation – STOP! Do not approach the tire. Before removing from restraining device, completely deflate the tire remotely. Remove the clip-on air chuck. The tire must be marked appropriately, made unserviceable and non-repairable and then scrapped!

If none of these conditions are present, with the valve core still removed, continue to Step 3.



**FIGURE 25: This is just one type of restraining device available for tire service facilities. With the valve core removed, inflate tire using a clip-on air chuck with a pressure regulator and an extension air hose.**





**FIGURE 26:** At 20 psi, you can begin to see the presence of distortions in the sidewall of this truck tire (circled in red). Due to a heavier sidewall construction, bus and refuse tires would present this condition at 40 psi.

### Step 3 - Inflate Tire to 20 PSI over Cold Inflation Pressure on Sidewall

#### Continue Inflation

If none of the “zipper rupture” conditions are present during Step 2 (initial inflation 20 psi for light truck and medium truck tires; 40 psi for bus and refuse tires), then continue the inflation process in the restraining device, with the valve core still removed, using a clip-on air chuck with a pressure regulator and an extension air hose.



**FIGURE 27:** Bulged Sidewall

Always remain outside the tire’s trajectory.

For light truck and medium truck tires, continue inflating the tire to 20 psi over the cold inflation pressure molded on the tire sidewall — but do not exceed 120 psi.

For tires designed for bus and refuse applications, continue inflating the tire to 20 psi over the cold inflation pressure molded on the tire sidewall — but do not exceed 140 psi.

Below are some examples of visible sidewall conditions that are indicative of a pending “zipper rupture.” In Figure 27, note the bulge in the sidewall; in Figure 28, note the undulating rippled sidewall.

Throughout inflation process in Step 3, always

#### Listen For:

- Any snapping, popping or crackling sounds

#### Look For:

- Distortions or undulations (ripples and/or bulges) in the sidewall

If any of these conditions are present during inflation of the tire – STOP! Do not approach the tire. Before removing the tire from the restraining device, completely deflate the tire remotely. Remove the clip-on air chuck. The tire must be marked appropriately, made unserviceable and non-repairable and then scrapped.

If none of these conditions are present, remove the clip-on air chuck, install the valve core, and adjust the inflation pressure to the recommended operating inflation pressure.



**FIGURE 28:** Undulating Rippled Sidewall **21**

## Tire Service Life

It is important to have tires in good operating condition, thus tires may need to be replaced because of service conditions long before the tread is worn out. To determine if tires, including the spare, should remain in service, it is recommended that they be periodically inspected by a tire service professional during routine preventive maintenance intervals. The service life of tires includes their overall condition and vehicle usage factors, not just tread wear. All of these factors should be taken into account when considering tire replacement.

Follow the vehicle and tire manufacturers' specific recommendations, if any, regarding tire service life and replacement. In order to determine the age of the tire, look for the last four digits of the DOT tire identification number (see Chapter 1, "Basic Tire Information" for details). See Figure 29 for DOT TIN date code examples.

Tires that have been permanently removed from service should be rendered unserviceable and destroyed so no one else can use them.

**Tire Service Life is Not Determined by Chronological Age** - Tires are composed of various materials, including rubber, having performance properties essential to the proper functioning of the tire. These component properties evolve over a combination of time, service and storage conditions. For each individual tire, this change is affected

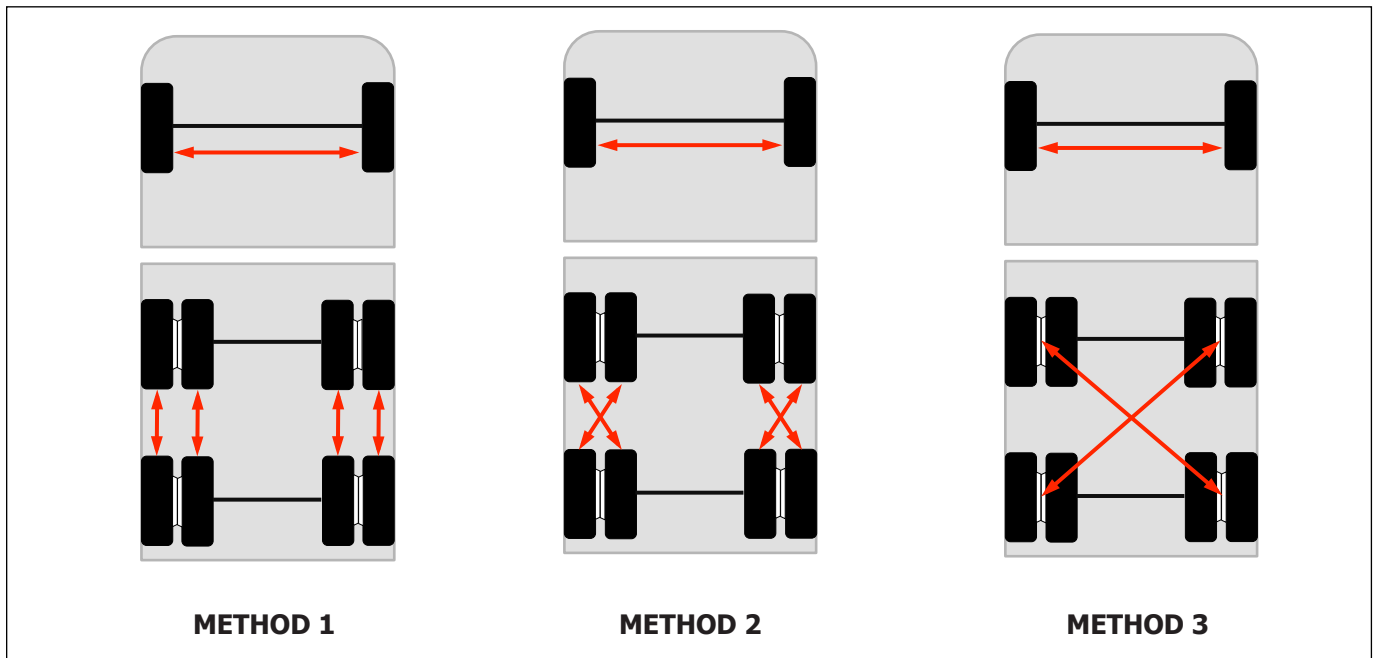
by many elements such as temperature, storage conditions, and conditions of use (e.g. load, speed, inflation pressure, impacts and road hazard injury) to which a tire is subjected throughout its life. Since service and storage conditions vary widely, accurately predicting the actual serviceable life of any specific tire based on calendar age is not possible. USTMA is not aware of accurate and reliable scientific or technical data that establishes a specific minimum or maximum service life for truck tires. However, in some cases a tire or vehicle manufacturer may make a specific tire replacement recommendation regarding its products. If so, consult the manufacturer with any questions with regard to following the recommendation. Furthermore, any such recommendation should not be considered a minimum service life for the tire.

⚠ **WARNING**

Driving on damaged tires is dangerous. A damaged tire can suddenly fail leading to situations that may result in serious personal injury or death. Tires should be regularly inspected by a qualified tire service professional.

TIN Regulation Effective Date	DOT Symbol	Mfr. ID / Plant Code	Tire Size Code	Mfr. Tire Type / Descriptive Code	Week	Year	Date of Manufacture "Date Code" Examples	
Original Regulation	DOT	XX	XX	XXXX <small>(OPTIONAL)</small>	XX	X	025	2 <sup>nd</sup> week of 1995 <small>(possibly 1996 or 1975)</small>
July 2, 2000	DOT	XX	XX	XXXX <small>(OPTIONAL)</small>	XX	XX	0908	9 <sup>th</sup> week of 2008
April 13, 2015	DOT	XX	XX	XXXX <small>(OPTIONAL)</small>	XX	XX	4815	48 <sup>th</sup> week of 2015
either type of TIN is permissible	DOT	XXX	XXXXXX		XX	XX	3218	32 <sup>nd</sup> week of 2018
April 13, 2025	DOT	XXX	XXXXXX		XX	XX	2325	23 <sup>rd</sup> week of 2025

**FIGURE 29: DOT TIN Example**



**FIGURE 30: Typical Tire Rotation Methods**

## Tire Rotation

The purpose of regularly rotating tires is to prolong tread life and promote more uniform tread wear for all tires on a vehicle, particularly those showing signs of irregular or rapid wear. For typical truck tire rotation patterns, see the examples above. Note that steer axle tires are normally rotated side to side and drive axle tires are rotated between axles or side to side.

If tires show uneven tread wear, check for and correct any misalignment, imbalance, or other mechanical problems before rotation.

For wide base single drive tires, rotation method 1 or 3 is possible.

When tires are rotated, the inflation pressures must be adjusted for the tires' new positions in accordance with the vehicle manufacturer's recommendations; see the vehicle tire placard, certification label, or service manual. Under inflation may result in rapid and/or abnormal tread wear, improper vehicle handling and decreased fuel economy. Over inflation can also result in rapid and/or abnormal tread wear, decreased traction and premature wear of suspension components. Improper tire inflation may cause a tire failure, including tread/belt separation, even at a later date, which can lead to an accident and serious personal injury or death. See "Proper Tire Inflation" on p. 9.

### NOTE

These federal regulations may be applicable when rotating tires:

- Federal Motor Carrier Safety Administration Regulation 49 CFR 393.75(d) specifies that no bus shall be operated with regrooved, recapped or retreaded tires on front wheels.
- Federal Motor Carrier Safety Administration Regulation 49 CFR 393.75(e) specifies that a regrooved tire with a load carrying capacity equal to or greater than 4,920 pounds shall not be used on the front wheels of any truck or truck tractor.
- National Highway Traffic Safety Administration Regulation 49 CFR 570.62(d) specifies that reinforcement repairs to the cord body are allowable on tires other than front-mounted tires. (Reinforcement repairs on radial truck tires are typically referred to as section repairs.)

## Conditions Affecting Tread Wear

### Service Conditions

Tread wear is affected by many different vehicle operating conditions. Abnormal wear typically results from a combination of unsatisfactory conditions and may make an accurate diagnosis of the cause(s) difficult. It is important to identify the emergence of abnormal wear in its early stage and correct the cause before valuable tire tread wear is lost. Most of the causes of abnormal tread wear can be corrected. The causes can include excessive tire stresses due to driving habits, road surfaces, terrain and axle position. See Figure 40 on p. 27 for examples of abnormal tread wear.

### Driving Habits

The way a vehicle is driven has a great deal to do with tread wear and safety. Observe posted speed limits and avoid hard stops, starts and cornering. In addition, avoid potholes, objects on the road, and curbs (such as cutting a corner and running over a curb). The rate of wear increases during hard cornering at both high and low speeds due to scuffing caused by lateral forces, particularly on the front axle, tag axle and spread axle trailer tires. Hard acceleration or braking will also cause increased wear due to torque and weight transfer.

### Road Surfaces/Terrain

Rapid or abnormal tread wear may be caused by abrasive road surfaces such as those with sharp or coarse highway paving materials. Areas that have numerous hills or curves can also lead to accelerated tread wear.

### Axle Position

The position of a tire on a vehicle determines what stresses the tire will experience. The tires on the drive axle are affected by acceleration. Free-rolling trailer tires may also experience some abnormal tread wear. Rotating tires on the vehicle may help to minimize abnormal wear.

### Maintenance Conditions

There is a close relationship between several mechanical systems on a vehicle and its tires. Tires, wheels, brakes, shock absorbers, drive train, steering and suspension systems, etc., must all function together to perform safely and comfortably and to give optimum tread wear. Improper or inadequate vehicle maintenance can cause tires to wear rapidly and/or abnormally. All of the following maintenance conditions can be adjusted or repaired.

### Improper Tire Inflation

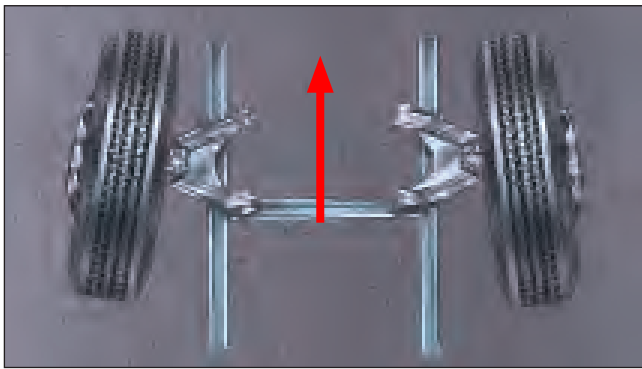
Use the inflation pressures specified by the vehicle manufacturer on the vehicle tire placard, certification label or service manual. Under inflation may result in rapid and/or abnormal tread wear, improper vehicle handling and decreased fuel economy. Over inflation can also result in rapid and/or abnormal tread wear, decreased traction and premature wear of suspension components. Improper tire inflation may cause a tire failure, including tread/belt separation, even at a later date, which can lead to an accident and serious personal injury or death. The inflation pressure in all tires, including the spare tire and inside duals, should be checked with an accurate tire gauge frequently, such as daily during continuous service, pre-trip inspections, and at preventative maintenance intervals. See "Proper Tire Inflation" on p. 9.

### Vehicle Wheel Misalignment

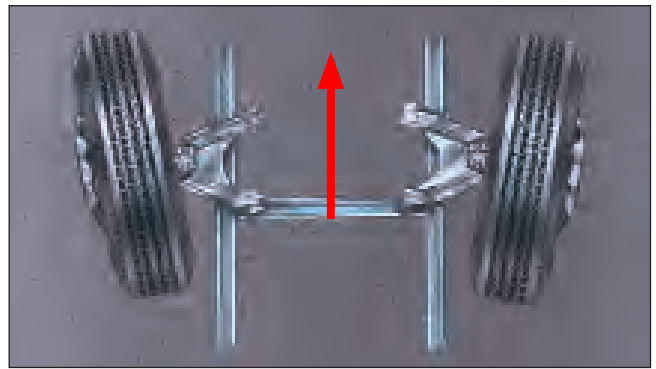
If both the tractor and trailer wheels are not properly aligned, tires will experience stresses as if they were constantly cornering. This will cause increased and abnormal tread wear. The vehicle alignment geometry should be checked periodically as specified by the vehicle service manual or if misalignment is suspected. For any vehicle, an alignment check can identify problems such as "dog tracking," when rear tires do not follow in the paths of the tires in front of them. This can also result in abnormal tread wear. A qualified mechanic should correct misalignment of wheels.

Toe wear and wear due to misaligned drive axles can be detected by rubbing your hand back and forth over the tread surface to feel for raised surfaces. Tire scrubbing will cause feathering of the tread elements. If the tread feels smooth as you slide your hand inboard and rough as you slide it outboard, this indicates toe-in. The opposite is true for toe-out.

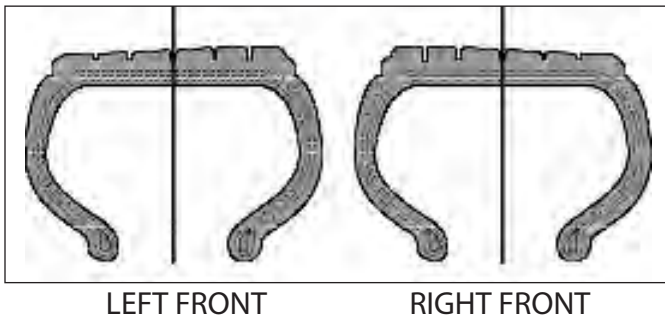
Toe is a basic front-end setting that is a common cause of irregular wear. Toe-in occurs when the distance between the front of the tires is less than the distance between the rear of the tires. See Figure 31. Toe-out occurs when the distance between the front of the tires is greater than the distance between the rear of the tires. See Figure 32. Irregular wear occurring from excessive toe is illustrated in Figures 33 and 34. Figures 31 through 34 may be found on p. 25.



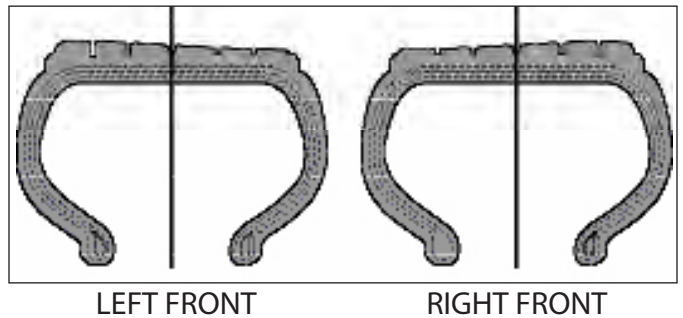
**FIGURE 31: Toe-In**



**FIGURE 32: Toe-Out**



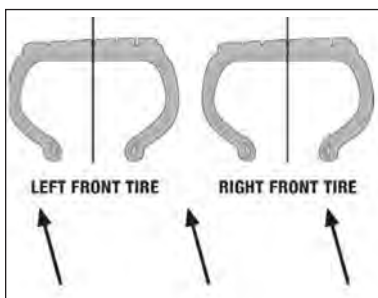
**FIGURE 33: Toe-In Wear**



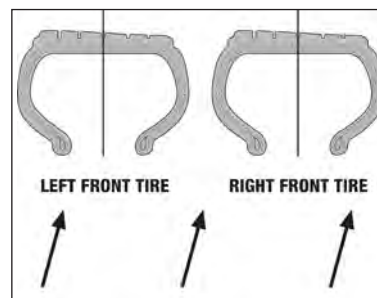
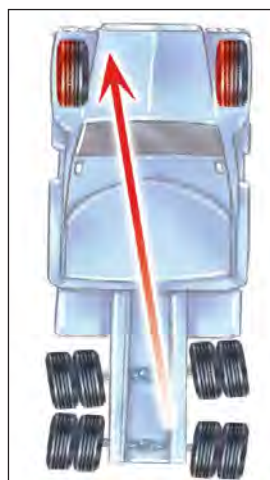
**FIGURE 34: Toe-Out Wear**

Misaligned drive axles “thrust” the truck to one side, requiring steering input to travel straight. The two main categories of drive axle misalignment are scrub/skew angle (drive axles not parallel to each other) as shown below, and thrust angle (drive axles not pointing straight ahead). See Figures 35 and 36.

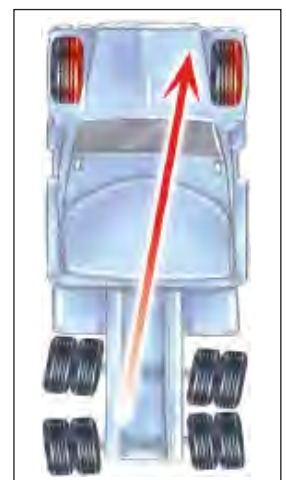
If the drive axles of a vehicle are out of alignment, you may detect the resulting irregular wear pattern by rubbing your hand across the tread surface of the steer tires.



**FIGURE 35: Left Thrust** - The drive axles push the truck left. Shoulder wear occurs on the left side (outboard) side of the left front tire. Shoulder wear also occurs on the left (inboard) side of the right front tire.



**FIGURE 36: Right Thrust** - The drive axles push the truck right. Shoulder wear occurs on the right side (inboard) side of the left front tire. Shoulder wear also occurs on the right (outboard) side of the right front tire.



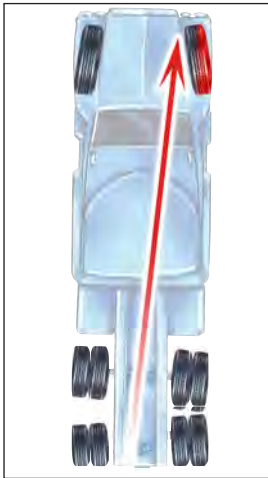
There are also combinations of toe misalignment and drive axle misalignment, which cause scrubbing wear on only one steer tire.

### Right Thrust – Toe-in

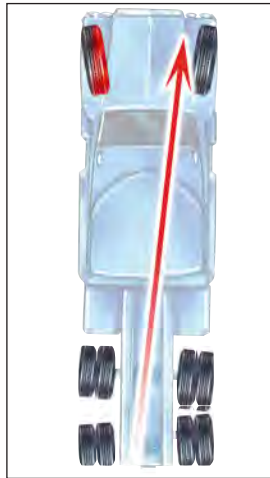
Toe-in with a right thrust causes the left front tire to wear normally, but the right front tire will have outer shoulder wear. Right thrust complaints are more common than left thrust complaints in the United States. This is due to the crowning of the roads of the interstate highway system.

### Right Thrust – Toe-out

Toe-out with a right thrust causes the right front tire to wear normally, but the left front tire will have inner shoulder wear.

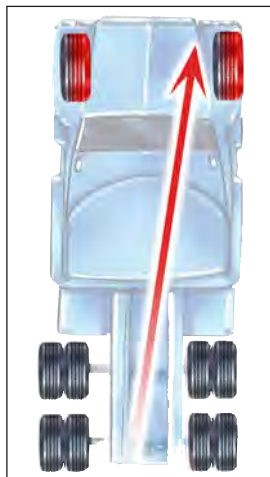


**FIGURE 37:  
Right Thrust Toe-in**



**FIGURE 38:  
Right Thrust Toe-out**

Another source of right thrust: If the drive axles are off-center (jacked to the left), it causes a situation similar to an off-center motor on a motor boat.



**FIGURE 39:  
Off Center Drive**

### Lack of Tire Rotation

Tire rotation procedures are established to equalize the tread wear for each tire to prolong tread life. By regularly changing a tire to another position on the vehicle, any abnormal wear patterns that were starting to develop may be improved. See "Tire Rotation" on p. 23.

### Tire and Wheel Assembly Out-of-Balance

A tire and wheel assembly that is out-of-balance can cause abnormal tread wear due to vibration and irregular road contact which may be worse at specific speeds. See "Tire/Wheel Balancing and Installation" on p. 31.

### Damaged Wheels

Damaged wheels can cause a tire to contact the road unevenly and cause abnormal tread wear. Wheel damage may not be visually obvious and should be checked by a tire service professional using proper measuring equipment.

### Brakes in Disrepair

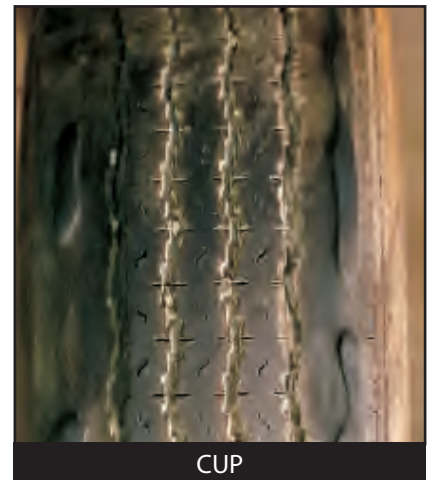
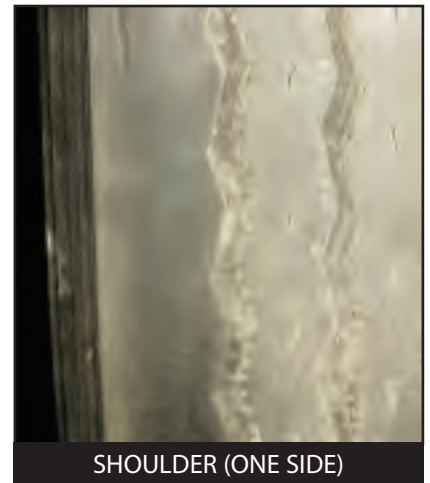
If not in proper working order, brakes can grab unevenly and cause abnormal tread wear.

### Shock Absorbers

A worn or leaking shock absorber will not properly dampen vehicle motion and cause abnormal tread wear.

### Worn or Loose Suspension and Steering Systems

Excessive wear and looseness anywhere in the suspension and steering systems (such as tie-rod ends, kingpins, wheel bearings and air springs) can cause tire and wheel assemblies to move in ways in which they were not designed. This will cause rapid and/or abnormal tread wear.



**FIGURE 40: Examples of Abnormal Tread Wear**

(All images courtesy of The Technology & Maintenance Council of the American Trucking Associations.)

There are manuals published by the Technology and Maintenance Council of the American Trucking Associations (TMC-ATA) that may be used by service facilities, truck stops, tire dealers, state motor vehicle inspection stations, etc., as a reference for inspection of tires, rims, and wheels:

- "Radial Tire Conditions Analysis Guide"
- "Radial Tire & Disc Wheel Service Manual"
- "Users Guide to Wheels and Rims"

## Aftermarket Sealants and Balancing Products

Flammable propellants and/or liquids in aftermarket sealants or aerosol inflators may cause a tire to explode under certain circumstances. Never introduce a flammable substance into a tire. Tire service professionals should assume that any aftermarket product used to seal or inflate a tire is flammable. In addition to following proper demounting procedures (see Chapter 5), take the following precautions:

- Keep the tire away from heat, flame, sparks or other ignition sources
- Use tools with caution - particularly tire irons, reamers and hammers, to avoid causing sparks
- Work in a well-ventilated area - and with the tire secured to a vehicle, tire mounting machine or other restraining device - remove the valve core and completely deflate the tire
- Reinflate and deflate the tire a few times to further dissipate and expel potentially flammable vapor

### **⚠WARNING**

Never, under any circumstance, introduce a flammable substance into a tire. Igniting this substance in an effort to facilitate seating the beads is extremely unsafe. This may result in an explosion of the tire with force sufficient to cause serious personal injury or death. This practice may also result in undetected damage to the tire or rim that could result in failure of the tire in service.

### **⚠WARNING**

Serious injury or death may result from an explosion of the tire and rim/wheel assembly due to heating the rim/wheel. Never rework, weld, braze or heat a wheel or rim.

The USTMA does not endorse aftermarket sealants or balancing products such as aerosols, liquids, gels or other substances. Only products that are determined to have no damaging or harmful effect on the tire, tube, flap, valve or wheel/rim should be used.

Aftermarket sealants are not considered proper repairs.

- Do not use products that may be flammable or potentially explosive
- Do not use products that are petroleum based or that may damage the tire

Additional considerations regarding the use of sealants and balancing products:

- They may void the tire manufacturer's warranty
- Do not use products that may interfere with or damage tire pressure monitoring system sensors
- Do not use products that may negatively impact valve stem grommet life
- Do not use products that may foul valve stems and valve cores
- Do not use products that may corrode wheels
- They must be removed from the innerliner prior to inspection, repairing or retreading processes

Consult the tire manufacturer's service recommendations and warranty policy. See "Tire Explosions and Flammable Substances" on p. 30.

### **Built-In Self-Sealing Layer**

Some manufacturers produce new tires with a self-sealing layer between the innerliner and body ply. This layer generally runs across the crown of the tire and seals nail holes or similar punctures in that area to prevent air loss. Since this sealant is an integral part of the tire, it does not need to be removed prior to retreading.

### **Used Truck Tires**

This information pertains to truck tires with their original tread and retreaded tires that have been used in service. These tires may be intended for replacement purposes or they may already be installed on a used vehicle.

Once new tires (with their original tread) or newly retreaded tires are applied to a vehicle and put into service (this includes spare tires), they are considered "used."

There is a potential risk associated with the installation of used tires that have uncertain or unknown history of use, maintenance or storage conditions. Such tires may have damage that could eventually lead to tire failure.

Not all tire damage that can lead to tire failure is outwardly visible. For instance, improper repairs or damage to a tire's innerliner can only be observed by inspecting the inside of the tire, demounted from the wheel. A qualified tire service professional should inspect the internal and external condition of the used tires prior to application. In the case of a newly purchased used vehicle, the only way to determine the condition of its tires is to have them demounted by a tire service professional for the same type of inspection.



## ⚠ WARNING

Driving on damaged tires is dangerous. A damaged tire can suddenly fail leading to situations that may result in serious personal injury or death. Tires should be regularly inspected by a qualified tire service professional.

## NOTE

Don't sell, use or retread tires whose original DOT marking/serial number has been removed, obliterated or branded over.

USTMA does not recommend the installation of used tires that exhibit any of the following characteristics:

- Any improper puncture, section or other repair (see Chapter 4, "Repair, Retread and Regrooving" on p. 40)
- Any innerliner or bead damage
- Indication of internal separation, such as bulges or local areas of irregular/fast tread wear indicating possible tread or belt separation
- Indication of run flat, under inflated and/or over loaded damage (e.g. innerliner abrasion, mid- to upper sidewall abrasion and lettering deterioration, delamination, or discoloration, excessive tread shoulder wear, etc.)
- Any damage or wear exposing the body material of the tire - cuts, cracks, bulges, scrapes, ozone cracking/weather checking, impact damage, punctures, splits, snags, etc.
- Defaced or removed DOT tire identification number(s) (TIN), which is located on the tire sidewall
- Involved in a recall or a replacement program
- Inadequate tread depth for continued service (i.e. nearly worn out)
- Currently mounted on a rim that is bent, dented, cracked or otherwise damaged
- Evidence of improper storage (see "Tire Storage Recommendations" on this page)
- Chemical, fire, excessive heat damage, or other environmental damage
- Designated as a "scrap tire" or otherwise not intended for continued highway service
- Evidence of prior use of tire repair sealant
- Labeled on the sidewall as "Not For Highway Use," "NHS," "Agricultural Use Only," "SL" (service limited agricultural tire), or any other indication that the tire is barred from use on public thoroughfares if the tire is intended for over the road use
- Any other condition which would be cause for permanent removal from service

## Spare Tire Maintenance

Spare tires should not be neglected during regular inspections and inflation pressure checks. Spare tires mounted on

wheels should have their inflation pressure checked with an accurate tire gauge frequently, such as daily during continuous service, pre-trip inspections, and at preventative maintenance intervals. Inspect the spare and rim/wheel periodically for any visible damage to the tire or corrosion on the wheel. Always check and adjust the inflation pressure of the spare upon installation.

## Tire Storage Recommendations

Stored tires should be protected against environmental effects such as sunlight, high heat, ozone and other potentially damaging conditions.

- Store tires where the area is clean, dry and well ventilated, but with a minimum of circulating air
- Store tires in an area with temperate ambient conditions (mild temperatures, shaded or dark)
- Store tires raised off a storage area's floor surface to minimize exposure to moisture or damage
- Avoid contact with petroleum-based products and/or other volatile solvents or substances
- Store tires away from electric motors, battery chargers, generators, welding equipment or other ozone generating sources

Indoor storage is recommended, however if tires must be stored outdoors:

- Store tires where they are raised off the ground (or on storage racks) and not in contact with heat absorbent surfaces
- Protect tires with an opaque, waterproof covering with some type of vent openings to avoid creating a "heat box" or "steam bath" effect

### If tires are mounted on a stored vehicle:

Store the vehicle such that all weight is removed from the tires. If vehicle weight cannot be removed, unload the vehicle to minimize the weight. Maintain the recommended tire inflation pressure, including the spare. The surface where parked/stored should be firm, reasonably level, well drained and clean. The vehicle should be moved every three months so the tire flex area is changed.

### Returning tires from storage back to service:

Before placing stored tires back into service, a tire service professional should conduct a visual and tactile inspection to be sure each tire is clean, dry, free of foreign objects, and/or does not show signs of damage. See "Tire Inspection Guidelines and Conditions" on p. 14. Once mounted on a rim/wheel, the tire (including the spare tire) should be inflated to the recommended inflation pressure. See "Proper Tire Inflation" on p. 9.

Refer to USTMA Tire Information Service Bulletin, Vol. 23, "Tire Storage Recommendations."

## Cleaning Tires

Clean tires with soap and water and a soft bristle brush or a shop cloth. Treating tires with incompatible dressings or harsh cleaning agents will hasten oxidation and result in premature cracking. Never use petroleum-based products as tire dressings/cleaners. Use of a pressure washer or steam cleaner may be damaging to the tire.

## Tire Explosions and Flammable Substances

Inflation pressure in a tire represents tremendous potential energy. If improperly treated, a tire can explode, suddenly releasing the stored-up energy which may result in serious injury or death. Causes of tire/wheel assembly explosions can include:

- Tire damaged during mounting/demounting
- Tire mounted on the wrong size rim
- Improper mounting/demounting procedures
- Use of flammable solvents during tire mounting or to seat beads
- Exceeding maximum pressure limitation of the tire
- Flammable liquids or vapors introduced into the tire including sealants and aerosol inflators
- Welding, heating, or brazing an inflated tire/wheel assembly
- Improper tube fitment and pinching of the tube between the rim and tire during inflation
- Reinflating a tire which has been run in an under inflated or over loaded condition
- Tire damaged in service or improperly repaired and reinflated
- Brake overheating
- Exceeding maximum pressure limitation of the rim

Refer to USTMA Tire Information Service Bulletin, Vol. 3, "Tire Explosions Caused by Tire Spinning".

Refer to USTMA Tire Information Service Bulletin, Vol. 41, "Tire Bead Lubricants, Mounting Aids, Bead Sealers, OEM Mobility Kits, Tire Sealants, Balancing Substances and Flammable Substances."

Avoid flammable vapors inadvertently being pumped into a tire when the tire is inflated.

- Do not use alcohol, methanol, dry gas or any other flammable material in the compressor tank to prevent freezing or condensation
- Do not store flammable solvents or rubber cements near the compressor intake
- Do not clean the compressor intake screen/filter with flammable solvents such as gasoline
- Do not use a battery charger near the compressor intake. This can result in hydrogen gas being drawn into the compressor

Locate the compressor indoors where freezing will not occur and in an area by itself away from operations such as tire repairing, battery charging, etc. Each day, open the bleed valve on the tank to expel moisture. Add a filter, trap, or dryer to the compressor to remove moisture.

## Tire Spinning

The centrifugal forces created by a rapidly spinning tire can cause an explosion by literally tearing the tire apart. These forces act on the complete tire structure, and can be of such magnitude as to break the beads in addition to rupturing the tire. Some vehicles are able to bring a tire to its centrifugal force failing point in just 3-5 seconds.

- When stuck on ice, snow, mud, or wet grass, the vehicle should be rocked gently (alternately using forward and reverse gears) with the least amount of wheel spinning. Shift the gear lever repeatedly from drive to reverse while applying gentle pressure to the accelerator. Vehicles with ABS or traction control systems need to follow the instructions in their service manual
- Never exceed 35 mph (56 km/h) indicated speed on the speedometer
- Never allow anyone to stand near a spinning tire

See USTMA Tire Information Service Bulletin, Vol. 3, "Tire Explosions Caused by Tire Spinning".

### **⚠ WARNING**

Excessive speed in a free-spinning tire can cause the tire to explode from extreme centrifugal force. The energy released by such an explosion is sufficient to cause serious physical injury or death. Never spin a tire above a speedometer reading of 35 mph (56 km/h). Never stand near a spinning tire.



## Tire/Wheel Balancing and Installation

Tires that have been damaged by improper demounting/mounting procedures may fail prematurely. For instance, a torn bead may cause gradual inflation pressure loss and even lead to internal tire separation. For detailed instructions on mounting truck tires, see Chapter 5 "Demounting and Mounting Procedures Including Multi-Piece Rim Matching" on p. 53. Chapter 5 includes an OSHA booklet for demounting/mounting procedures for tubeless and tube-type truck and bus tires, including multi-piece rim matching information.

### ⚠ WARNING

Tire changing can be dangerous and should be done by trained personnel using proper tools and procedures. Always read and understand any manufacturer's warnings contained in owner's manuals, on the equipment, listed on websites and molded onto tire sidewalls.

Failure to comply with these procedures may result in faulty positioning of the tire and/or rim parts and cause the assembly to burst with explosive force sufficient to cause serious physical injury or death. Never mount or use damaged tires or rims.

For more information on tire mounting safety and procedures, see Chapter 5, "Demounting and Mounting Procedures Including Multi-Piece Rim Matching".

Tire/wheel balance is important for proper/tire tread wear. Out-of-balance conditions may reduce tire mileage significantly and can be the source of vehicle vibration and bounce. Maintaining tire/wheel balance over the service life of the tire helps to maximize the tire's performance.

There are two types of out-of-balance conditions for tire/wheel assemblies that cause vibration at highway speeds. See Figure 41. Static balance, also known as single plane balance, may result in vibration due to vertical (up and down) movement. It can be corrected using a bubble or spin balancer. Uneven distribution of weight across another axis of the wheel causes vibration due to rotational movement (wobble or shimmy). It can only be corrected using a dynamic spin balancer which also can correct static imbalance.

The USTMA does not endorse any type of tire sealants or tire balancing products. Only products that have been determined to have no damaging or harmful effect on the tire, tube, flap, valve assembly and/or rim should be used.

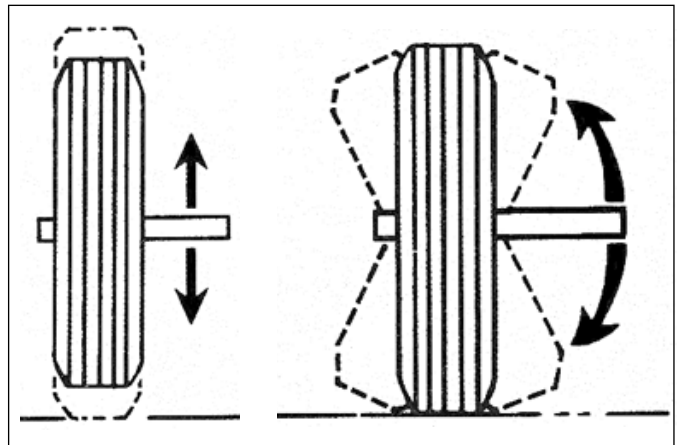
**Dynamic Computer-Controlled Balance Machine Set-up and Usage** - Tire/wheel service centers using dynamic spin balancing machines establish the optimal balance of the tire/wheel assembly by correcting both types of imbalance.

### ⚠ WARNING

#### TIRE SEALANTS AND BALANCING SUBSTANCES

Solvent-based liquids must not be used due to the possibility of creating explosive mixtures of vapors in the tire, which may result in serious injury or death.

Only trained tire service professionals should perform tire balancing. Balancing equipment should be properly set up and calibrated with particular attention to the wheel assembly alignment (e.g. hub-centric or lug-centric wheels). With larger truck tires, flange plate adaptors may be required to obtain accurate tire/wheel balance.



**FIGURE 41: Two Types of Tire/Wheel Imbalance**

**Tire/Wheel Assembly Installation** - Consult the vehicle service manual for recommendations on tire/wheel assembly installation. Identify lug torque specifications for proper installation. It is recommended that lug nuts and bolts be tightened to exact torque specifications with a torque wrench. Improper torque, either too loose or too tight, may cause loss of lug nuts, breaking of the stud(s), damage to the tire/wheel assembly, or detachment of the tire/wheel assembly from the axle. Always use a torque wrench for final tightening and follow accepted tightening (torqueing) procedures.

## Ride Comfort Optimization Procedures and Diagnostics

**Tire Manufacturer Match-Mount Markings** – Some new tires may be marked by the manufacturer to indicate the location (such as the "high point") that should be matched to a particular location on a wheel. The marking is generally a colored-spot on the sidewall. It should be matched to a

location on the wheel (such as the “low point”). Consult with the tire manufacturer for the meaning of match-mount markings and recommendations for match-mounting to wheels.

**Match-Mount and Balancing Machines** - User expectations and increased sensitivity of vehicles have resulted in additional procedures to produce a smooth, quiet ride. Modern ride optimization machines may be used to resolve many ride/vibration complaints.

These machines have the capability of evaluating the tire/wheel assembly and the wheel alone following prescribed match-mounting procedures. Match-mounting techniques can minimize potential vibration. Wheel measurements can highlight possible wheel irregularities. Use of these machines can assist with diagnosis of tire/wheel-related vibration complaints.

However, match-mounting and balancing machines are not laboratory or factory-grade tire uniformity measurement machines and should never be used to screen new tires for uniformity. Consult the tire manufacturer for its policy regarding tires evaluated using match-mount and balancing machines.

**Manual Ride Optimization Procedure (Manual Run-Out Method)** - Follow these steps to manually diagnose a tire/wheel assembly suspected of causing vibration:

1. Test drive the vehicle to determine where the vibration is originating.
2. Place the suspect tire and wheel assembly on the balance machine and check its balance. Correct if necessary and test drive the vehicle again.
3. If the balance is acceptable and the vibration is still present, next check the tire and rim for run-out.
  - a. Place the suspect tire and wheel assembly on the balance machine.
  - b. Place a run-out gauge or dial indicator in the center of the tire tread. Set the gauge at zero.
  - c. Slowly rotate the tire and rim assembly 360 degrees. While rotating, observe the gauge and determine the location of greatest run-out. Mark that location on both the tire tread and wheel.
  - d. Deflate the tire and rotate it, until the mark on the tire is exactly opposite from the mark on the wheel (180 degrees).
  - e. Reinflate the tire. Recheck the tire/wheel assembly run-out by slowly rotating the assembly 360 degrees.
  - f. If the run-out has been reduced, rebalance the tire/wheel assembly, install on the vehicle and perform a test drive. If the run-out has not been reduced, find the peak run-out. If the peak run-out is located near

the area where the rim was originally marked, the rim may be the cause. Consult the rim manufacturer. If the peak run-out is located near the area where the tire was marked, the tire may be the cause of vibration. Consult the tire manufacturer.

### NOTE

To confirm the run-out of the rim, it may be necessary to demount the tire and check the rim with a run-out gauge indicator against each bead seat ledge.

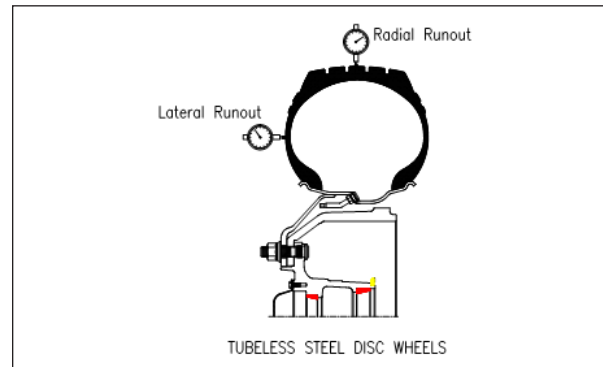


Image Courtesy of the Technology and Maintenance Council of the American Trucking Associations

**FIGURE 42: Run-Out Gauge Placement**

## Tire Branding

Most truck tires have a branding panel molded on the sidewall. Tire branding must be done with care. The ideal branding depth is 1/32.” In no case should it exceed 2/32.” Whenever possible, the branding panel on the sidewall should be used. If no branding panel is provided, brand the tire sidewall between the rim flange and the tire’s maximum section width. Avoid branding too deeply or in the wrong spot, to prevent cracks from starting at the brand and spreading outwards. These cracks can become deeper, eventually reaching the body cord, resulting in a tire failure. Never brand in the critical sidewall flexing areas near or above the tire’s maximum section width.



**FIGURE 43: Tire Branding**

## Overview

The purpose of this chapter is to provide tire industry recommended guidelines and important safety information when replacing tires for trucks and buses. While this chapter is intended to outline general guidelines and considerations for tire replacement, it is not all-inclusive. Questions pertaining to specific products and/or vehicle fitments should be addressed to the vehicle manufacturer, tire manufacturer, or tire dealer. Because tire technology continually evolves, visit the USTMA website at [www.USTires.org](http://www.USTires.org) for current information.

### NOTE

Before replacing tires, always refer to and follow the vehicle manufacturer's tire replacement recommendations and restrictions.

## The Right Tire For the Vehicle

When tires need to be replaced, do not guess what tire is right for the vehicle. For the answer, refer to the vehicle certification labels, such as Figure 44, which include tire and loading information, affixed to the vehicle in locations depending on vehicle type. These areas include: driver's door, hinge pillar or seating area; near the instrument panel; or other access door near the driver. The vehicle certification label identifies the size of the tires that were installed on the vehicle as original equipment (OE). The certification label also specifies the recommended cold inflation pressures for the tires on all positions and gross axle weight ratings and gross vehicle weight ratings. If the vehicle does not have a certification label, consult the vehicle owner's manual, vehicle manufacturer, or tire manufacturer. Also, check the vehicle owner's manual or service manual for any additional tire replacement recommendations. A tire dealer should also be familiar with these requirements and is an excellent resource. See Figures 10, 11, 12 and 13 in Chapter 2 for additional examples of vehicle certification labels.



**FIGURE 44: Truck Certification Label**

To select the right tire for the job, the following items must be considered:

- The proper tire size
- The proper load capacity for the axle/vehicle maximum weight ratings
- The proper tire inflation
- The proper speed capability
- The proper service application for the tire

In addition, tires have very useful information molded into the sidewall including the tire brand, model, size, speed rating, maximum load, cold inflation, and safety warning(s). See Chapter 1, "Basic Tire Information".

Operating conditions vary widely, so tires should be selected carefully to assure maximum tire service life. (For instance, a dump truck may be used to haul gravel over the highway from pit to job or to haul gravel at much slower speeds just in the pit or construction project.) It is preferred not to mix different tire constructions on the same vehicle. Also speed, distance and road conditions must be considered when selecting the proper type of tire or tread design. At sustained high speeds, excessive heat can build up and cause tire damage or failure. Tires with a speed restriction at or below 55 MPH (90 KM/H) will be labeled on the sidewall with the marking:

MAX SPEED \_\_\_\_\_ KM/H ( \_\_\_\_\_ MPH)

Replacement tires must have:

- Sufficient load carrying capacity to meet the GAWR(s) specified on the vehicle certification label
- Inflation pressure capacity suitable for the load, speed, application and service conditions. See p. 8 "Proper Tire Inflation"

Carefully note differences between the load (GAWR) and inflation pressure requirements for each axle position.

## Tire Size, Speed Rating, Load and Inflation

### Correct Tire Size Determination

Replacement tires should be the same as the OE size designation, or approved options, as recommended by the vehicle or tire manufacturer.

**Inflation Pressure: OE vs. Replacement** - Fitment of a new tire (other than the OE size) on the vehicle may require different inflation pressure than specified on the vehicle certification label to adequately carry the load. If so, the tire service professional should inform the owner of the new required inflation pressure. The tire service professional

should also place a sticker or decal next to the vehicle certification labels showing the new tire size and inflation pressure requirements for future reference.

Always refer to the vehicle certification label before selecting a replacement tire. If selecting a replacement tire size different from the size or sizes shown on the vehicle certification label, be sure the replacement size has sufficient load carrying capacity to meet the GAWR requirements. Always consult the tire and vehicle manufacturers' literature for rim/wheel selection and other considerations. Always check and follow the recommendations in the vehicle owner's manual. See "Proper Tire Inflation" on p. 9.

### NOTE

Always check the vehicle manufacturer's recommendations for the OE tire size, load capacity, inflation pressure, and speed rating information before replacing a tire with a different size and construction. It is not always possible to select the same tire size for a replacement size. Never choose a tire with less load-carrying capacity than required to meet the GAWR specified on the vehicle certification label.

### Tire Speed Ratings

Replacement tires should have a speed capability that meets the requirements of the vehicle and the expected service conditions.

States continue to increase speed limits (many in excess of 70 mph) on certain highways and this trend may continue. While the higher speed limits are applicable to all motor vehicles including trucks and buses, tires on these vehicles may not have the speed capability to meet these new higher speed limits and should not be operated beyond the tire speed rating.

The speed capability of a truck/bus tire may be determined in one of the following ways:

1. Tires that are speed restricted to 55 mph or less are required to have the maximum speed marked on the sidewall such as "MAX SPEED 90 KM/H (55 MPH)"
2. Tires may be marked with a letter speed symbol (such as F, G, J, K, L, M, etc.). See Table 3 on p. 6.
3. Contact the tire manufacturer or refer to their product specifications for speed capability for truck/bus tires that do not have a speed restriction or a speed symbol marked on the sidewall

A tire speed rating does not imply the vehicle can be safely driven at that speed, particularly under adverse road and weather conditions or if the vehicle has unusual characteristics. Never operate a vehicle in an unsafe or unlawful manner. If any tire has a lower speed capability than the vehicle, the vehicle speed must be restricted to the speed capability of that tire.

### Determine the Axle/Vehicle Maximum Weight Rating

The load per axle must always be less than the maximum specified capacity of the tires and the rims/wheels. Tire load capacity is dependant on inflation pressure. Tire manufacturer and/or Tire and Rim Association, Inc. load and inflation tables must be referenced in order to properly select alternate replacement tires. An example table is shown in Table 4 on the next page. Do not exceed the rim/wheel specifications for maximum load or maximum pressure.

If selecting a replacement tire size different than the size or sizes shown on the vehicle certification label, be sure the replacement size has adequate load carrying capacity. Divide the Gross Axle Weight Rating (GAWR) shown on the vehicle certification label by the number of tires on each axle. Then select tires whose combined load capacity equals or exceeds the GAWR. For tire load capacities, refer to the maximum tire load rating stamped on the tire sidewall near the bead area or tire manufacturers' literature. Using tires of greater load capacity than indicated by the GAWR or Gross Vehicle Weight Rating (GVWR) will not increase the load capacity limit of the axle or the total vehicle. Components other than tires may be critical items which determine the GAWR or GVWR. A vehicle may be weighed under fully loaded conditions to determine if the tires meet conditions for proper use in the intended application.

Federal Motor Vehicle Safety Standard No. 119 requires the following information on the sidewall of all truck tires:

MAX LOAD SINGLE \_\_\_\_\_ kg ( \_\_\_\_\_ lb)  
AT \_\_\_\_\_ kPa ( \_\_\_\_\_ psi) COLD

MAX LOAD DUAL \_\_\_\_\_ kg ( \_\_\_\_\_ lb)  
AT \_\_\_\_\_ kPa ( \_\_\_\_\_ psi) COLD

Tires rated only for single use are labeled:

MAX LOAD \_\_\_\_\_ kg ( \_\_\_\_\_ lb)  
AT \_\_\_\_\_ kPa ( \_\_\_\_\_ psi) COLD

### Correct Service Application for the Tire

Tires are designated with suffix letters such as TR, ML, MH, NHS, etc. that differentiate between specific service conditions. See "Tire size suffix identification for type of service and proper rim contour" on p. 2.

## Radial Ply Tires for Trucks, Buses and Trailers Used in Normal Highway Service Tires Mounted on 15° Drop Center Rims

Tire Load Limits (kg./lb.) at various Cold Inflation Pressures (kPa/psi) Pressure Listed is the Minimum for the Load

TIRE SIZE DESIGNATION	USAGE	Tire Load Limits (kg./lb.) at various Cold Inflation Pressures (kPa/psi) Pressure Listed is the Minimum for the Load													
		kPa	480	520	550	590	620	660	690	720	760	790	830		
11R22.5	DUAL	psi	70	75	80	85	90	95	100	105	110	115	120		
		kg.	1990	2080	2160	2250	<b>2360 (F)</b>	2460	2560	<b>2650 (G)</b>	2680	2710	<b>2725 (H)</b>		
	lb.	4380	4580	4760	4950	<b>5205 (F)</b> <sup>138</sup>	5415	5625	<b>5840 (G)</b> <sup>142</sup>	5895	5950	<b>6005 (H)</b> <sup>143</sup>			
	SINGLE	kg.	2050	2160	2260	2370	<b>2500 (F)</b>	2600	2700	<b>2800 (G)</b>	2870	2940	<b>3000 (H)</b>		
295/75R22.5	DUAL	lb.	4530	4770	4990	5220	<b>5510 (F)</b> <sup>140</sup>	5730	5950	<b>6175 (G)</b> <sup>144</sup>	6320	6465	<b>6610 (H)</b> <sup>146</sup>		
		kg.	1860	1950	2060	2130	2220	<b>2300 (F)</b>	2390	2470	<b>2575 (G)</b>	2630	<b>2725 (H)</b>		
	lb.	4095	4300	4540	4690	4885	<b>5070 (F)</b> <sup>137</sup>	5260	5440	<b>5675 (G)</b> <sup>141</sup>	5795	<b>6005 (H)</b> <sup>143</sup>			
	SINGLE	kg.	2040	2140	2240	2340	2440	<b>2500 (F)</b>	2620	2710	<b>2800 (G)</b>	2890	<b>3000 (H)</b>		
		lb.	4500	4725	4940	5155	5370	<b>5510 (F)</b> <sup>140</sup>	5780	5980	<b>6175 (G)</b> <sup>144</sup>	6370	<b>6610 (H)</b> <sup>146</sup>		

Letters in parentheses denote Load Range for which Bold Face loads are maximum. International Load Index numbers are shown after Load Range.

The load/inflation values in the table above have been established by the Tire and Rim Association, Inc. Other standards may vary; consult the tire manufacturers' tables.

**TABLE 4: Example Load/Inflation Table**

## Mixing Tire Sizes

For all trucks: Never mix different tire sizes and/or tire constructions (radial or non-radial) on the same axle.

For trucks with two axles: If the vehicle is equipped with single tires in all positions, and if mixing radials and non-radials is necessary, install the radial tires on the rear and non-radial tires on the front. Each vehicle axle must use the same tire size, similar tread design and construction (radial or non-radial) since differences can lead to loss of control.

If the vehicle is equipped with dual rear tires, then radial or non-radial tires may be used on the front axle, the rear axle or on both axles. Never mix constructions on the same axle.

For trucks with more than two axles: The front tires may be either radial or non-radial and can be run with either radial or non-radial tires on the drive axles.

For all trailers: Single-axle trailers may use either all radial or all non-radial tires. Multiple axle trailers may use radial or non-radial tires on all positions or intermix radial and non-radial, as long as all tires on each axle are the same construction.

Paired tires should be of the same size designation, same construction and tread design, and be properly matched. See "Matching Dual Tires" on p. 37. Never pair a radial and non-radial tire as duals.

## Tire Diameter and Tire/Vehicle Clearance

Acceptable load index, load capacity, and/or overall diameter do not imply acceptable vehicle clearance. Body and chassis clearance must be checked on the vehicle's front and rear axles. If replacement tires or rims are of a different size from the original equipment, all wheel positions must be checked for proper clearance in the fender well, around brake components, shock towers, other suspension components, etc. These wheel positions must be checked for full suspension jounce and rebound. Steering tires must be checked in full left and right turns. Also, check to be sure that the outside circumference of all tires is within the accepted tolerance of the vehicle manufacturer.

Differences in overall diameter may affect vehicle handling and stability as well as the following: speedometer, odometer, ABS, tire pressure monitoring system, traction control, and other electronic systems. To maintain accuracy, resetting or recalibration of these systems may be necessary. Compare the nominal dimensions of the tires listed on the vehicle certification label and candidate replacement sizes. Check the vehicle manufacturer's recommendations.

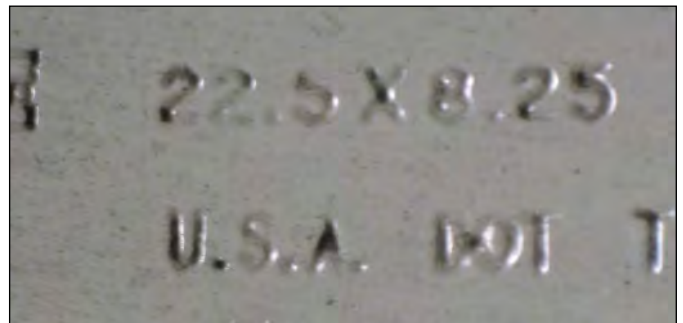
## Rim/Wheel, Tube and Flap Selection

### Rim/Wheel

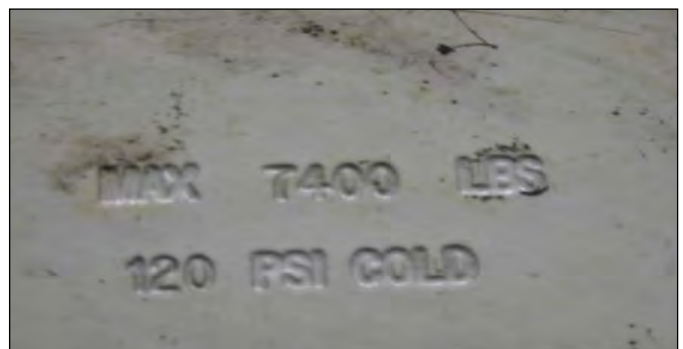
Mount tires only on approved rims (diameter, width and contour) as defined by the tire or wheel manufacturer or industry standard books or guidelines. Load, cold inflation pressure and tire construction forces imposed on the rim/wheel must not exceed the rim and wheel manufacturer's recommendations, even if the tire is approved for higher load or inflation. Never exceed the maximum pressure and/or load capacity of the rim/wheel. Not all rims/wheels are approved for use with radial tires. Radial tires can place higher stresses on rims/wheels than do non-radial tires, so the proper matching of a radial tire with a radial rim/wheel is extremely important. Figures 45 and 46 show the typical rim/wheel stamping.

### NOTE

Always use approved tire and rim combinations for diameters, widths and contours.



**FIGURE 45: Wheel Dimensions**



**FIGURE 46: Maximum Wheel Load and Inflation Pressure**



## Tubes and Flaps

For tube type tires, be sure to use approved tubes/flaps/valves for the replacement tire. The tube type tire and the load on it is supported by air pressure in the tube, so satisfactory performance of the tube is vital. When used in radial tires, radial tubes and radial flaps are required. Flexing characteristics of a radial truck tire require a special tube. In a radial truck tire, always use a tube specifically identified for use with radial ply tires. The radial tube size must be the same as the tire size. For example, use a 10.00R20 tube in a 10.00R20 tire.

When ordering flaps for use with radial tires specify radial flaps. They are also specially designed for use with radial truck tires. For correct radial flap sizes, check the tire manufacturer's specifications. Always check for the correct designation before installing a flap in a radial truck tire.

## Matching Dual Tires

Proper spacing between duals (minimum dual spacing) is necessary for optimum tire performance. Consult the tire or vehicle manufacturers' literature for recommendations. Paired tires should be of the same size designation, same construction, and tread design and as close as possible to the same outside diameter. Never pair a radial and non-radial tire as duals. Mismatching duals forces the larger diameter tire to carry an overload, causing it to over deflect and overheat. The smaller diameter tire lacking proper road contact, wears faster and irregularly. Tire damage such as tread or ply separation, tire body breaks and blowouts can develop from mismatched duals.

Maximum allowable differences between a tire and its dual mate at equal inflation pressures are:

### Dual Matching Tolerance

Radius	0" to 1/8"
Diameter	0" to 1/4"
Circumference	0" to 3/4"

Determine the actual difference in diameter by measuring the tires (with a steel tape) at least 24 hours after initial inflation. Matching should be done before installing the tires on the vehicle. However, after tires are installed, measurements can be made by straight edge, stationary tire meter, or large square. See Figures 47 and 48.

To avoid excessive or irregular tread wear and avoid damage to the differential, duals on tandem drive axles should have an average difference in diameter of no more than 1/4" between the two axles, whatever the tire size.

If chains are used in winter weather conditions, there must be adequate clearance between loaded tires to avoid damage from the chains themselves. See p. 38 for more information about the use of chains.



**FIGURE 47: Dual Tire Meter**



**FIGURE 48: Tire Caliper**

## Recreational Vehicle (RV) Applications

An RV may have any one of a variety of different types of tires including: light truck tires, special tires for trailers (ST), and truck/bus tires. Often at or near maximum loads, tires used on RV's are typically subjected to a greater variety of loading conditions than automobile, light truck and truck applications.

Many RV's end up over loaded simply because of the tendency to place additional items in them. There is often no quick way to determine the weight of the items loaded, so there is a temptation to keep loading until most of the available space is filled. Most people tend to load by volume when weight is far more important. Unfortunately, these circumstances will tend to exceed the load-carrying capacity of the tires or axles long before everything is on board. The only way to determine if the vehicle is over loaded is to have it weighed.

Even though RV users often put no more than a few thousand miles on their tires a year, RV tires may need to be replaced because of service conditions long before the tread is worn out. To determine if RV tires, including the spare, should remain in service, it is recommended that they be periodically inspected by a tire service professional, including an inspection before every travel season and during routine RV maintenance intervals like oil changes and tire rotations. The service life of tires includes their overall condition and vehicle usage factors, not just tread wear. All of these factors should be taken into account when considering tire replacement. Follow vehicle and tire manufacturers' specific recommendations, if any, regarding tire service life and replacement.

For further information regarding RV tires including tire inspection and weighing of the vehicle, see "Recreational Vehicle Applications" in Chapter 4 of the USTMA manual, "Care and Service of Passenger and Light Truck Tires."

## **⚠ WARNING**

Under inflation and/or over loading of a tire causes excessive heat build-up and internal structural damage. This may cause a tire failure, including tread/belt separation, even at a later date, which can lead to an accident and serious personal injury or death.

Over loading an RV can have other serious safety consequences such as suspension or wheel failure, increased braking distance or brake failure (particularly on steep grades), and adverse vehicle handling/stability.

Consult the vehicle tire placard, certification label and owner's manual for the recommended vehicle load limits and tire inflation pressures.

## **Use of Chains**

The use of chains can be helpful in providing additional traction in severe weather conditions (such as ice and heavy snow), especially when travelling in hilly or mountainous terrain. In some areas, they may legally be required. Consult local laws for chain usage. The chains can be used with radial tires provided several points are followed:

- Always select chains that are specifically designed for radial tires. These chains normally have shorter cross chains than older designs and allow the position of the side chains to be higher on the sidewall. This is out of the high-flex sidewall area of a radial tire and results in less susceptibility to sidewall damage.

- Always use the proper chain size for the tire on which it is attached. Tighten chains when they are first applied. Then after a short run-in period readjust the chains to ensure a snug fit on radial tires. Serious sidewall or vehicle damage may result from loose chains.
- Check for adequate dual spacing, especially if using single tire chains on each tire in a dual assembly. The greater deflection of the radial tire may require more dual spacing in marginally spaced dual assemblies.
- Always remove chains as soon as they are no longer needed.

## **⚠ WARNING**

Driving on damaged tires is dangerous. A damaged tire can suddenly fail leading to situations that may result in serious personal injury or death. Tires should be regularly inspected by a qualified tire service professional.

## **Tire Rolling Resistance**

Tire rolling resistance is a product of several factors including heat loss in the rubber as the tire flexes; frictional loss as the tire rolls through contact with the road; and aerodynamic loss as the tire moves through the surrounding air. A growing emphasis on improving fuel economy and reducing vehicle emissions has increased the desire for ways to reduce truck tire rolling resistance without adversely affecting other tire performance characteristics. There are many factors that impact vehicle fuel efficiency other than rolling resistance. See Figure 49 on p. 39. They include: speed, load, fuel quality, traffic conditions, terrain, use of accessories, air temperature, tire pressure maintenance, vehicle design, engine design, tire and axle alignment and driver behavior/vehicle operating style.

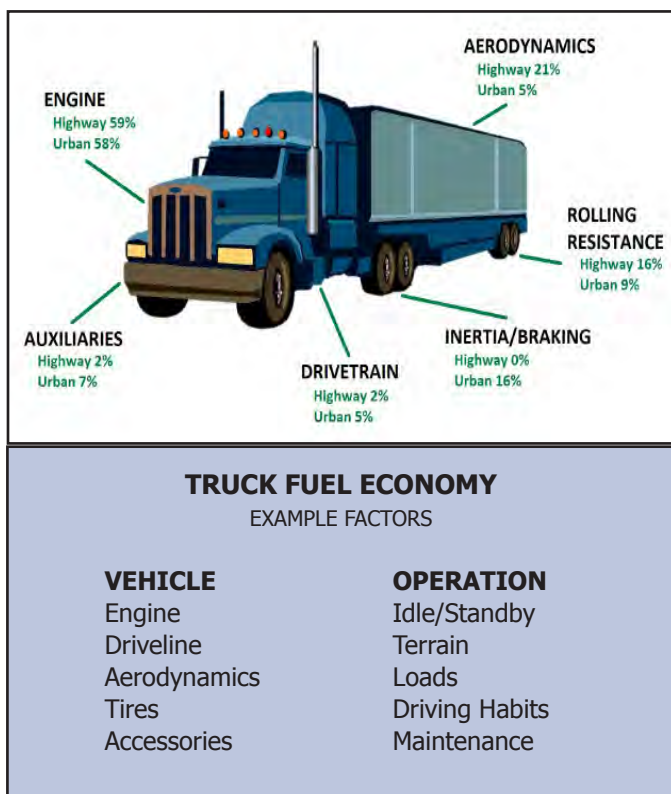
Research indicates that reduced rolling resistance tires can be a cost effective investment in some applications. Contact tire manufacturers for more information regarding products with reduced tire rolling resistance.

The SmartWay® Program is a public/private initiative between the Environmental Protection Agency (EPA), large and small trucking companies, rail carriers, logistics companies, commercial manufacturers, retailers, and other federal and state agencies. Its purpose is to improve fuel efficiency and the environmental performance in an effort to reduce greenhouse gasses.

SmartWay aims to accelerate the availability, adoption and market penetration of advanced fuel efficient technologies and operational practices in the freight supply chain, while helping companies save fuel, lower costs and reduce adverse environmental impacts. EPA helps SmartWay Partners move more goods, more miles with lower emissions and less energy.

For more information, see [www.epa.gov/smartway](http://www.epa.gov/smartway).

In December 2008, the California Air Resources Board mandated implementation of SmartWay for tractor-trailer combinations operating in California. Many fleets and truck operators are required to specify low rolling resistance tires.



**FIGURE 49: Truck Fuel Economy**

## Tire Registration and Recall Information

Registration of tires is an important step to complete when placing them into service. Registration enables manufacturers to contact the consumer in the event of a recall.

At the point of sale, consumers should be provided a tire registration card. This information should be completed and submitted as soon as possible. USTMA tire manufacturer members also provide online tire registration forms that can be submitted electronically.

Consumer contact information and DOT Tire Identification Numbers (TIN) are necessary for registration. In addition, DOT TINs are necessary to determine whether a tire is subject to a recall.

Visit [www.USTires.org](http://www.USTires.org) for links to USTMA member tire registration websites and for a tire recall look up tool.

# CHAPTER 4 - REPAIR, RETREAD AND REGROOVING

## Proper Tire Repair

Truck/bus tires may be repaired for a wide variety of injuries, from a nailhole-size tread puncture to a large cut through the upper sidewall, by following the guidelines and procedures outlined in this section and by conforming to recommendations of the tire manufacturer.

Proper truck tire repair depends on many things, particularly the following:

- Removal of the tire from the rim/wheel
- Inspection of the tire interior and exterior
- The extent of the injury
- Training and experience of the tire service professional
- Equipment and materials that are used

Not all tires can be repaired. For instance, tires driven even a short distance while under inflated may be damaged beyond repair. Running a tire under inflated is like running the vehicle's engine without enough oil or coolant. It may seem to work fine for a time, but serious permanent damage has occurred. Adding oil or coolant won't repair engine damage, and adding inflation pressure won't fix tire damage. The tire will remain seriously damaged and can still fail, even after inflation pressure is corrected.

The following are some examples of tires with conditions or injuries that must not be repaired:

- Any damage exceeding USTMA or tire manufacturer recommended repair limits
- Damage from running flat, under inflated and/or over loaded
- Separations of tread, sidewall or bead area components
- Injuries near each other that would result in overlapping repair units
- Bead wires visible, broken, or deformed
- Excessive chafing or rim grooving in the bead area
- Deep circumferential cracks or brittle bead rubber
- Sidewall or tread cracking that exposes cord
- Weather checking (cracking) that exposes cord
- Sidewall scuffing/abrasion that exposes cord
- Open innerliner splices or cracks that expose cord
- Blistered, loose or detached innerliner
- Deterioration caused by grease, oil or other materials

Tires exhibiting these or any other non-serviceable conditions must be permanently removed from service (scrapped) and disposed of properly.

### **⚠WARNING**

Improperly repaired tires can fail while in service, such as by tread/belt separation, which can lead to an accident and serious personal injury or death.

Tires must always be properly repaired according to USTMA procedures such as the USTMA wall chart, "Puncture Repair Procedures for Truck/Bus Tires".

**Limitations on Quantity of Repairs** - The number of repairs should be limited first by the tire manufacturer's recommendations and repair policies. The condition and application of the tire should also be considered. In any case, repair units must not overlap. Injuries must be far enough apart to enable each repair to be conducted independently and without the repair units coming into contact with each other when completed. Multiple injuries to the same radial cable may be considered for a section repair. See p. 43 for more details.

**Speed Capability after Repair** - Contact the individual tire manufacturer for their policy or recommendations regarding tire speed rating/capability after repair.

**Identifying Potential Zipper Ruptures** - Any inflated truck/bus tire with a steel cord casing that is suspected of having been operated under inflated and/or over loaded must be approached with caution. A tire service professional must remove the valve core and completely deflate the tire before removing the tire/wheel/rim assembly from the vehicle. Clearly mark the tire in an appropriate manner indicating it has been run under inflated and has a potential for a zipper rupture.

Do not return the tire to service without following proper procedures, including an inspection by a tire service professional. See Chapter 2, p. 18 and the USTMA Tire Information Service Bulletin, Vol. 33, "Inspection Procedures to Identify Potential Sidewall 'Zipper Ruptures' in Steel Cord Radial Truck, Bus and Light Truck Tires".

**Tires Mounted in Dual Positions** - If one tire from a dual tire axle position becomes significantly under inflated or flat, the other tire will carry the load for both tires and result in an over loaded condition. Both tires should be inspected by a tire service professional for damage. See Chapter 2, "Tire Inspection Guidelines and Conditions" on p. 14.

**Aftermarket Sealants** - The USTMA does not endorse aftermarket sealant products. Aerosol, liquid, gel or other substances injected into a tire through the valve are not considered proper repairs. Such products may be flammable and potentially explosive, may damage the tire, may void the tire manufacturer's warranty and may interfere with or damage tire pressure monitoring system sensors.

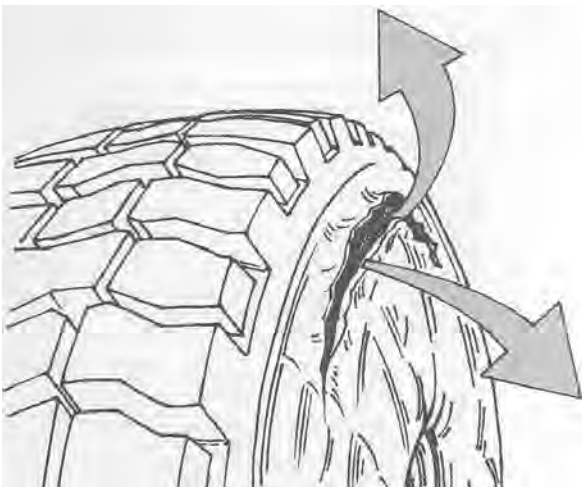
Consult the tire manufacturer's service recommendations and warranty policy. See Chapter 2, "Tire Explosions and Flammable Substances" on p. 30.

## ⚠WARNING

Any steel cord radial tire suspected of operating under inflated and/or over loaded must be approached with caution. Permanent damage due to operating a tire under inflated and/or over loaded cannot always be detected. Any tire known or suspected of being operated at 80 percent or less of normal operating inflation pressure and/or over loaded could possibly have permanent sidewall structural damage (steel cord fatigue).

Ply cords weakened by under inflation and/or over loading, may break one after another, until a rupture occurs in the upper sidewall with accompanying instantaneous pressure loss and explosive force. This can result in serious injury or death.

See USTMA Tire Information Service Bulletin, Vol. 33, "Inspection Procedures to Identify Potential Sidewall 'Zipper Ruptures' in Steel Cord Radial Truck, Bus, and Light Truck Tires".



## ⚠WARNING

Tire changing can be dangerous and should be done by trained personnel using proper tools and procedures. Always read and understand manufacturer's warnings contained in owner's manuals, on the equipment, listed on websites and molded onto tire sidewalls.

Failure to comply with these procedures may result in faulty positioning of the tire and/or rim parts and cause the assembly to burst with explosive force sufficient to cause serious physical injury or death. Never mount or use damaged tires or rims.

For more information on tire mounting safety and procedures, see Chapter 5, "Demounting and Mounting Procedures Including Multi-Piece Rim Matching".

## Tire Repair Materials, Tools and Equipment

A full-service tire repair facility should have the proper materials, tools, equipment and trained tire service professionals necessary to conduct the full range of truck tire repairs, including puncture, section, and spot repairs.

The USTMA does not endorse or recommend the use of any particular brand or type of repair materials. However, when performing a repair, do not mix tire repair products from different manufacturers. Consult with tire and repair material suppliers/manufacturers for recommendations on the proper materials, tools and equipment for the types of repairs that are intended to be conducted.

Examples of equipment and work area features in a full-service tire repair facility include the following:

- Dedicated tire repair areas
- Bright ambient lighting
- Fixtures to hold tires and spread beads
- Work benches, tool cabinets
- Pneumatic and electric power sources
- Fire extinguishing/suppression equipment
- Fresh air supply and adequate ventilation
- Stocked and organized repair materials

There is a wide variety of hand tools and other accessories necessary for conducting proper tire repairs. Specifications and recommendations for tools are provided by numerous industry sources, including the USTMA, tire manufacturers, and repair/retreading manufacturers and suppliers. Examples of tire repair tools include the following:

- Personal protection equipment (such as safety glasses)
- Handheld lighting
- Tire crayons and markers
- Tape measure, ruler, and angle gauge
- Awls/probes
- Stitchers
- Flexible, curved, and tapered knives
- Shears/scissors
- Carbide bits/cutters
- Wire brushes, rasps
- Grind stones, carbide burrs
- Reamers
- Pliers
- Powered buffer, drill, and grinder
- Vacuum

## ⚠ WARNING

Serious eye or ear injuries may result from not wearing adequate eye goggles (or face shields) and ear protection while repairing tires.

Only use the proper tool for the job. For instance, tools should be appropriate for the size and type of injury and repair being conducted. If properly used, tools should not cause further damage to the tire.

Always use personal protection equipment such as eye goggles and ear protection. Read and follow all operating and safety instructions before using tools. Failure to do so could cause serious personal injury.

## Puncture Repair

Always read, understand and follow the USTMA wall chart "Puncture Repair Procedures for Truck/Bus Tires" which applies to truck/bus tires Load Range "F" and higher.

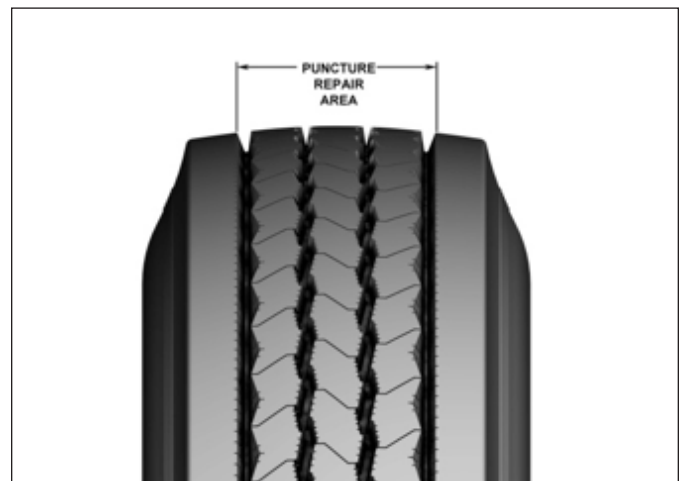
If a tire is losing inflation pressure, a tire service professional should check the tire surface, bead/rim interface, and the valve for the source of the suspected leak(s) by using water and soap solution (or immersion tank) prior to demounting the tire from the rim. Mark the injured area and totally deflate the tire. Then remove the tire from the rim being careful to avoid further damage to the tire, particularly to the bead area. Perform a complete internal inspection.

Only punctures within the area shown in Figure 50 up to 3/8 inch (10 mm) in diameter should be repaired according to the USTMA wall chart. Truck tires with larger injuries or those that extend or angle into the shoulder/belt edge area should not be repaired with a patch/plug repair; such tires may only be evaluated for a more specialized repair (for example, an USTMA-approved section repair) at a full-service tire repair facility.

The basic principles for proper puncture repair:

- Remove the tire from the wheel for inspection and repair
- Prepare the injured area
- Fill the injury with a suitable vulcanizing material or rubber stem that must fill the injury and keep moisture out
- Seal the innerliner with a patch to prevent loss of inflation pressure and keep moisture out
- Reinspect the finished repair

Refer to the USTMA wall chart for complete step-by-step procedures.



**FIGURE 50: Puncture Repair Area**

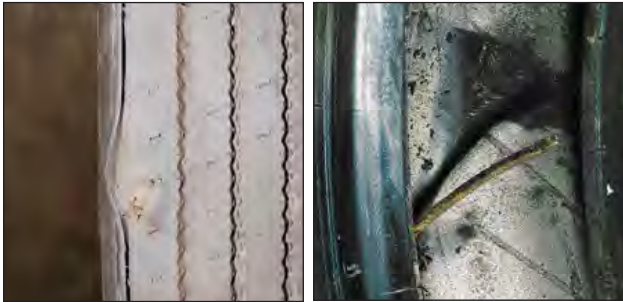
Not all punctures can be repaired. In addition to the USTMA puncture repair procedures, there may be additional limitations based on individual tire manufacturer repair policies. These may include the type of service such as speed rating, load index, and application. When repairing a tire puncture:

- Never perform a tire repair on-the-wheel
- Never use only a plug (stem)
- Never use only a patch

## ⚠ WARNING

Driving on damaged tires is dangerous. A damaged tire can suddenly fail, including by tread/belt separation, even at a later date, which can lead to an accident and serious personal injury or death.

Never perform a tire repair without removing the tire from the wheel assembly for a complete internal inspection. Do not perform an outside-in tire repair or an on-the-wheel repair.



The photo above is an example of a tire that was operated in an under inflated condition with a puncturing object that caused dangerous, non-repairable damage to the innerliner and body ply material. This type of damage would not have been visible from the outside of the tire.

Every tire must be removed from the wheel for an inspection and to assess repairability.

More than one puncture repair may be made in a truck tire; however, repair units must not overlap. Injured areas must be far enough apart to enable each repair to be conducted independently. A puncture repair patch must not come into contact with another puncture repair patch or section repair unit. Repair of multiple punctures in the tread area that damage the same radial cord(s) are not permitted unless they can be reinforced with a single section repair.

### Section Repair

When an injury to a truck/bus tire exceeds puncture repair limitations, under certain conditions a section repair in the tread or sidewall area may be performed. Limitations to the size and location of the injury that can be repaired depend on many factors including the tire size, manufacturer, and service conditions. Section repairs must be made in a full-service tire repair facility by properly trained personnel using proper tools, materials, and procedures.

The basic principles for a proper section repair:

- Remove the tire from the wheel for inspection and repair
- Prepare the injured area
- Fill the injury with a suitable vulcanizing material that must fill the injury and keep moisture out
- Seal the innerliner with a repair unit that reinforces the injured portion of the tire, prevents loss of inflation pressure, and keeps moisture out
- Re-inspect the finished repair

More than one section repair may be made in a truck tire; however, repair units must not overlap. Injured areas must be far enough apart to enable each repair to be conducted independently. A section repair unit must not come into contact with another section repair unit or puncture repair patch when completed. Multiple section repairs in the tread or sidewalls that share the same damaged radial cord(s) are not permitted. Tire manufacturers may have additional limitations on the quantity or location of section repairs.

**Appearance and Identification** - Section repairs can affect the external appearance of the tire in different ways depending on factors such as the size and location of the original injury, repair materials, and repair techniques. Thus, the repaired area may have visual characteristics including the following:

- Buff marks or textured appearance to the rubber
- Original tire markings obscured or removed
- Differences in rubber coloration
- Changes in the surface contour
- A bulge (raised area) above the surrounding surface

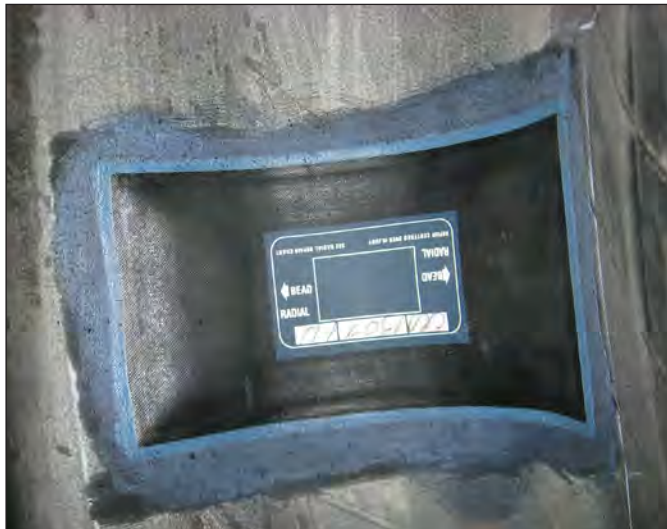
A bulge due to stretching of the rubber in the repaired area may be noticeable once the tire is fully inflated, particularly in the sidewall. A bulge is usually as wide as the repaired area and typically extends towards one or both beads. If any portion of the repaired area is bulging more than 3/8" above the surrounding surface of the tire, the section repair is not acceptable; the tire must be evaluated for further repair or permanently taken out of service (scrapped). In Figure 51 on p. 44, a section repair bulge is evaluated with a metal gauge having a 3/8" clearance.

### NOTE

If any portion of the repaired area is bulging more than 3/8" above the surrounding surface of the fully inflated tire, the section repair is not acceptable. The tire must be properly repaired or permanently removed from service (scrapped).



**FIGURE 51:**  
**Section Repair Bulge (Less than 3/8")**



**FIGURE 52:**  
**Completed Section Repair (Interior View)**



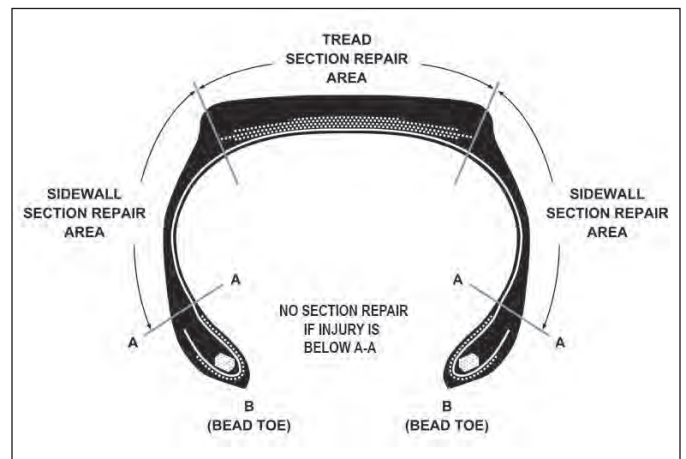
**FIGURE 53:**  
**Blue Triangle Patch Applied to Sidewall**

Use of a blue triangle identification patch, externally applied to the sidewall, makes it more evident that a section repair has been made to the tire and can prevent the tire or vehicle from being unnecessarily placed out of service by a safety inspector or other authority. The blue triangle should be equilateral, with each side having a dimension between 1/2" and 1-1/2" (13 mm to 38 mm). The identification patch should be affixed on the tire sidewall just above the rim flange and adjacent to the repair (not within the repaired area).

A completed section repair is shown in Figure 52, with an external, blue triangle patch shown in Figure 53.

**Size and Location Limitations** - Section repairs may be conducted in the tread and sidewall areas as shown in Figure 54.

Section repairs to sidewall injuries that extend into the bead area, from A-A to B as shown in Figure 54, are not permissible. Repair in this area is limited to rubber-only injuries such as to the bead toe region, and in some cases limited damage to chafer ply material. The casing manufacturer must be consulted for repair limitations in the bead area. Do not repair a tire with an injury that has broken or otherwise damaged any body ply cord in the A-A to B area; such tires should be permanently removed from service (scrapped) and disposed of properly.



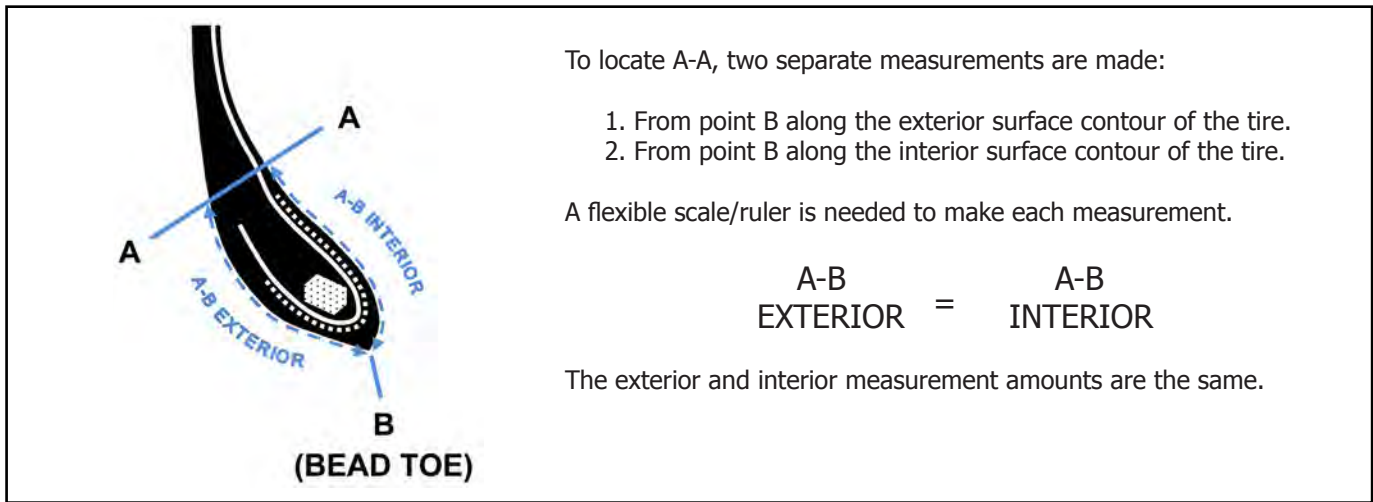
**FIGURE 54: Section Repair Areas**

A-A is located by measuring with a flexible scale/ruler from point B (at the bead toe) along the contours of both the exterior and interior surfaces of the tire as shown in Figure 54. The measurements depend on the tire type and size. See Table 5 on p. 45.

For repair of rubber-only injuries within the A-A to B area, see "Bead Area Repair" on p. 47 of this chapter.

Although a sidewall injury undergoing section repair must not extend into the A-A to B bead area, the section repair unit used to perform the repair may extend into this area.





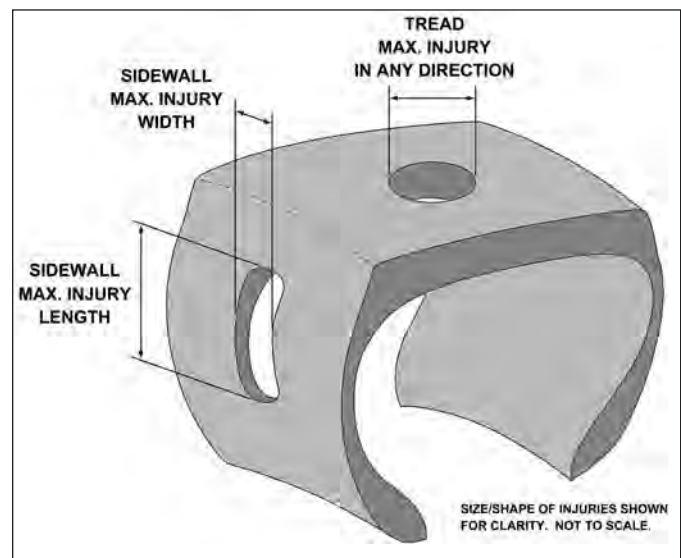
**FIGURE 55: Bead Area Measurements**

Tire Size Nominal Section Width		A-A to B Measurement	
Metric	Tubeless and Tube-Type	Up to 265	3.0 inch
		275 and Above	3.5 inch
Conventional	Tubeless	Up to 8R	3.0 inch
		9R and Above	3.5 inch
	Tube-Type	Up to 7.50R	3.0 inch
		8.25R and Above	3.5 inch

**TABLE 5: Measurement Values for A-A to B**

Measure the injury in the sidewall or tread area as shown in Figure 56. Examine the injury thoroughly to determine the extent of damage to structural materials such as body ply and belt cords. Cosmetic/minor damage to rubber-only, such as localized abrasion and tearing, is not necessary to include in the measurements.

Section repairs may be conducted on injuries up to the dimensions shown in Table 6 on p. 46 depending on the type and size of the tire. Manufacturers of tires and repair materials may have additional options and restrictions for their specific products. The objective of these limitations is to ensure that the structural integrity of the tire can be restored and also takes into consideration the durability of the section repair itself and the bulge limitation of 3/8 inch once fully inflated.



**FIGURE 56: Injury Measurements**

Tire Size Nominal Section Width			Sidewall Max. Injury*		Tread Max. Injury*
			Width	Length	
Metric	Tubeless and Tube-Type	Up to 235	3/8 inch	3.5 inch	1.0 inch
			3/4 inch	2.0 inch	
			1.0 inch	1.0 inch	
		245 to 285	3/8 inch	4.0 inch	1.5 inch
			3/4 inch	3.0 inch	
			1.0 inch	2.0 inch	
	295 to 365	3/8 inch	4.5 inch	1.5 inch	
		3/4 inch	4.0 inch		
		1.5 inch	2.0 inch		
	375 and Above	3/8 inch	5.0 inch	2.0 inch	
		3/4 inch	4.0 inch		
		1.5 inch	3.0 inch		
Conventional	Tubeless	Up to 8R	3/8 inch	3.5 inch	1.0 inch
			3/4 inch	2.0 inch	
			1.0 inch	1.0 inch	
		9R to 11R	3/8 inch	4.0 inch	1.5 inch
			3/4 inch	3.0 inch	
			1.0 inch	2.0 inch	
		12R to 15R	3/8 inch	4.5 inch	1.5 inch
			3/4 inch	4.0 inch	
			1.5 inch	2.0 inch	
		16.5R and Above	3/8 inch	5.0 inch	2.0 inch
			3/4 inch	4.0 inch	
			1.5 inch	3.0 inch	
	Tube-Type	Up to 7.50R	3/8 inch	3.5 inch	1.0 inch
			3/4 inch	2.0 inch	
			1.0 inch	1.0 inch	
		8.25R to 10.00R	3/8 inch	4.0 inch	1.5 inch
			3/4 inch	3.0 inch	
			1.0 inch	2.0 inch	
		11.00R to 13.00R	3/8 inch	4.5 inch	1.5 inch
			3/4 inch	4.0 inch	
			1.5 inch	2.0 inch	
		14.00R and Above	3/8 inch	5.0 inch	2.0 inch
			3/4 inch	4.0 inch	
			1.5 inch	3.0 inch	

**TABLE 6: Maximum Injury Dimensions for Section Repairs to Truck/Bus Tires**

\*Manufacturers of tires and repair materials may have additional options and restrictions for their specific products. Check with the tire manufacturer for specific recommendations and limitations for section repairs.

Since section repair materials and methodologies differ depending on the tire, injury, and manufacturer of repair materials, the USTMA does not provide step-by-step section repair procedures. Follow all repair materials manufacturer instructions and recommendations.

Section repairs conducted in the tread area may require removal of blocking/excess material from the grooves and restoration of the tread pattern. High spots may be buffed smooth to improve ride comfort.

Once a section repair is completed, the tire and repair should be inspected inside and out. The tire should be mounted and inflated to the maximum rated inflation pressure on the sidewall. See Chapter 5, "Demounting and Mounting Procedures Including Multi-Piece Rim Matching" on p. 53. As previously noted, the repaired area should not bulge more than 3/8" above the surrounding surface of the tire.

**Service Restrictions/Recommendations** - Based on federal in-use inspection standards (49 CFR 570.62(d)), tires with reinforcement repairs should not be used on the front axle of commercial vehicles over 10,000 pounds GVWR. (Reinforcement repairs on radial truck tires are typically referred to as section repairs.)

## Bead Area Repair

Repair in this area (refer to Figure 55 and Table 5 on p. 45) is limited to rubber-only injuries such as to the bead toe region, and in some cases limited damage to chafer ply material.

- If the chafer cords are rubber covered, there is no limit to rubber-only repair such as to the bead toe region
- If any chafer cords are damaged (broken, cut, loose or rusted) and the body ply cords are undamaged and rubber covered, repair with rubber to the chafer ply is limited by tire manufacturer recommendations; consult with the tire casing manufacturer
- If any steel body ply cord is exposed (metal showing) or damaged (broken, cut, loose or rusted) in the bead area, the tire must be rejected for repair and/or retreading

Do not repair a tire with an injury that has exposed, broken or otherwise damaged (such as cut, loose or rusted) any body ply cord in the A-A to B area; such tires must be permanently removed from service (scrapped) and disposed of properly.

## Spot Repair

A spot repair is performed to a superficial, rubber-only injury that does not require an interior patch or a section repair unit. Surface cuts and gouges are typical examples of injuries that can be spot repaired to limit further damage and/or improve appearance of the tire. If an injury has resulted in broken, cut, loose or rusted body ply cords, a spot repair should not be conducted; the tire should be evaluated for a section repair.

If an injury has resulted in exposed but undamaged body ply cords, the tire manufacturer should be contacted for a recommendation regarding spot repair.

Follow the repair materials manufacturer instructions for preparation of the injury, application of rubber fill material, curing and final finish of spot repairs.

## Preparation of Injuries to Belts Prior to Retreading

After a tire is buffed during the retread process (see "Retreading Truck Tires," p. 48), injuries to the steel belts may be exposed. Depending on the extent of the damage, certain injuries may be prepared by skiving and processed further without reinforcement.



**FIGURE 57: A Skive Repair in Process**

The objective of skiving, an example is shown in Figure 57, is to determine the extent of the injury and prepare it using these basic principles:

- Remove the least material possible
- Minimize the amount of exposed belt cord
- Avoid polishing or damaging undamaged belt cords
- Avoid overheating the rubber and belt cord
- Keep the overall area and depth as small as possible
- Vacuum to remove dust; do not use compressed air
- Apply cement and/or a suitable vulcanizing material to exposed belt cords

Limitations to the size and location/depth of belt injuries that can be skived depend on many factors, particularly the tire construction. Tire casing manufacturers must be consulted for specific information regarding steel belt constructions.

General limitations on skiving to each belt are as follows (casing manufacturers may have additional recommendations):

**“Protector” Steel Belt** - Not all truck/bus tires have an outermost protector ply. If present, it may be permissible to remove this ply in its entirety during retreading (consult casing manufacturer). However, if the damage is minimal, skiving limitations for the protector ply may follow those for the next ply down (first “structural” steel belt).

**First “Structural” Steel Belt** - For tires with a protector ply, this is the next ply down. For tires without a protector ply, this is the outermost steel belt ply. Damaged (broken, cut, loose or rusted) steel cords of the first structural steel belt may be skived out:

- Up to 0.5” across cords, for up to the full cord length
- 0.5” to 2.0” across cords, for up to 3.0” of cord length

**Second “Structural” Steel Belt** - This ply is beneath the first structural steel belt. Unless there is a split steel belt beneath this ply (see below), damaged (broken, cut, loose or rusted) steel cords of the second structural steel belt may be skived up to 0.75” across cords, for up to 0.75” of cord length.

**“Split” Steel Belt** - Skiving a split steel belt in a truck tire is not recommended, nor is skiving into the steel belt above it. Tires with damage to these plies should be considered for a section repair.

**Tires with Two Steel Belts** - Only the outermost belt may be skived according to the limitations given above for the first structural steel belt. Do not skive below the outermost steel belt.

In the absence of a clear understanding of the tire construction and casing manufacturer recommendations, only skive the outermost steel belt, following the skive limitations given above for the first structural steel belt. Do not skive below the outermost steel belt.

A tire that has damage to a ply that exceeds the limitations above should be considered for a section repair.

## Retreading Truck Tires

Retreading is a process where a new tread is applied to a used truck/bus tire casing. Retreading saves money and resources. Tires being retreaded pass through a rigorous process including numerous inspections. Retreaded tires can be part of a tire application and fleet management system.

The purpose of this section is to provide the general steps of the retreading process. There are numerous suppliers of state-of-the-art retreading equipment and materials that use a variety of retreading processes. Consult with those suppliers for the step-by-step procedures to produce quality retreaded tires.

The major steps of retreading include the following:

- Inventory Control
- Initial Inspection
- Buffing
- Repairs
- Tread Applications/Building
- Curing
- Final Inspection/TIN Marking

No single operation is more important than another; each step of the retread process builds on the previous steps.

## Retread Tire Identification Numbers

Retreaders are required to mark the sidewall of tires they retread with a code that identifies their manufacturing facility, date of manufacture and other information as indicated in Figure 58 on p. 49. It is recommended that this marking be made near the DOT marking of the original casing and that no prior DOT markings are obliterated. Certain states may require additional markings for retreaded tires; consult state requirements.

### NOTE

Don't sell, use, or retread tires whose original DOT marking/serial number has been removed, obliterated or branded over.

The original DOT marking consists of the DOT symbol followed by the tire identification number. See Figure 6, p. 6. Removal, branding over or obliteration of any portion of DOT marking indicates that the tire is no longer suitable for any use on or off the road. Some tires do not require DOT markings. Federal regulations permit the following:

- Those who retread tires for their own use and not for resale are not required to mark a tire identification number on those tires.
- Tires which are manufactured or retreaded exclusively for mileage contract purchasers are not required to bear the tire's identification number, if the tire contains the phrase, “for mileage contract use only,” molded into or onto the tire sidewall.

Imported truck tire casings which do not have an original manufacturer's DOT labeling (as opposed to having it removed), may be retreaded.

TIN Regulation Effective Date	Retread Symbol	Retreader Plant Code	Matrix or Size Code	Retreader Tire Type / Descriptive Code	Week	Year	Date of Manufacture "Date Code" Examples
Original Regulation	R	XXX	XX	XXXX <small>(OPTIONAL)</small>	XX	X	025      2 <sup>nd</sup> week of 1995 <small>(week 1985 or 1995)</small>
July 2, 2000	R	XXX	XX	XXXX <small>(OPTIONAL)</small>	XX	XX	0908      9 <sup>th</sup> week of 2008
April 13, 2015	R	XXX	XX	XXXX <small>(OPTIONAL)</small>	XX	XX	4815      48 <sup>th</sup> week of 2015
either type of TIN is permissible		R	XXX	XX	XX		3218      32 <sup>nd</sup> week of 2018
April 13, 2025	R	XXX	XX	XX			2325      23 <sup>rd</sup> week of 2025

**FIGURE 58: Retreaded Truck Tire Identification Number**

### Basic Retread Process

Two basic methods of curing retreaded radial tires are precure/"cold" curing (also known as chamber curing) and mold/"hot" curing (also known as matrix curing). In precure retreading, previously manufactured and cured tread rubber is applied to a prepared casing and cured in a chamber until the tread is bonded to the casing. In mold cure retreading, uncured tread rubber is applied to a prepared casing and placed into a mold that shapes and cures the tread.

### Major Steps in the Retreading Process

Tire retreading is a complex process that varies depending upon factors such as the condition of the tires, the retread system, customer requirements, and tire manufacturer recommendations. The major steps in most truck/bus tire retreading processes are outlined in general below and in Figure 59 on p. 49. For more specific and detailed information, including step-by-step procedures and recommendations, consult the tire manufacturer and retread supplier.

#### 1. Inventory Control

Initial processing of retread candidates requires identification and labeling of tires. Tires should be sorted into categories such as: customer, size and type of tire. A system of labeling and recording of a tire should be employed throughout the retreading process.

#### 2. Initial Inspection

Thoroughly examine all tires for external and internal irregularities and damage. There are many conditions that require a tire to be rejected for retreading and scrapped (permanently removed from service), including the following:

##### Tread:

- Excessively exposed or worn away cords
- Tread or belt edge separation
- Any damage exceeding the allowable repair limits or beyond repairable area
- Any injuries too close together; repairs must not overlap
- Cords exposed by improper regrooving

##### Sidewall:

- Any damage exceeding allowable repair limits or extending into the non-repairable bead area
- Deep weather checking or cracking
- Deterioration caused by grease, oil, or other material
- Excessive sidewall abrasion resulting in exposed cords
- Sidewall separations

##### Bead:

- Broken, distorted or excessively chafed beads
- Any exposed bead wires

- Beads cracked or brittle from heat
- Any damaged or exposed body ply
- Deep circumferential cracking at the bead area

Innerliner:

- Exposed body cords
- Ply separation, pulled or loose cords
- Run flat or under inflation/over loading damage

It is also recommended to use a nondestructive inspection process such as x-ray, shearography, high voltage current or ultrasonic methods to check for internal casing damage.

### 3. Buffing

Buffing removes the worn tread design to prepare the casing to accept the new tread for bonding. The three major objectives for buffing is to size the casing to fit a precure

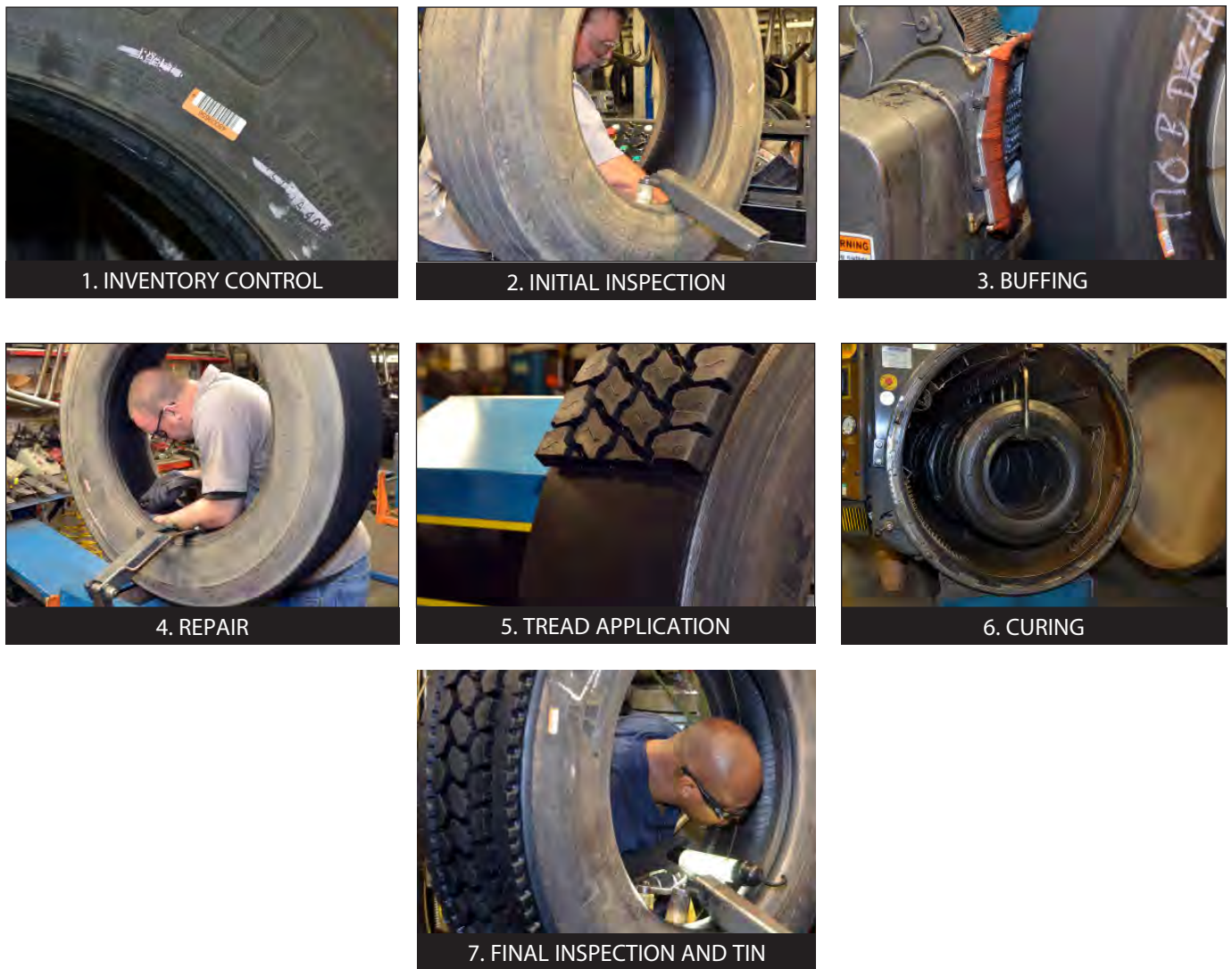
or mold cure tread; shape the crown to the proper contour and width for the curing system used; and to prepare the surface for the application of the new rubber to attain proper adhesion. Consult the tire manufacturer and retread supplier for specifications such as the recommended surface texture, amount of remaining undertread and crown radius.

### 4. Repairs

Some injuries to a tire casing are repairable. See “Proper Tire Repair” on p. 40.

### 5. Tread Application/Building

There are two main methods for bonding a new tread surface to a tire casing – precured tread systems (chamber) and uncured tread systems (matrix). Chamber type systems accommodate variations in tire diameter. Matrix type systems must meet the specified buffed circumference and gauge of



**FIGURE 59: Basic Retread Process**

## 6. Curing

Precured tread systems employ a tire envelope and pressure chamber to cure the new tread surface to tire casing. Matrix type systems use a mold that cures the uncured tread surface and imprints the tread pattern.

## 7. Final Inspection and TIN Marking

Thoroughly examine all tires for external and internal irregularities. In addition to other inspection criteria, precure tires should be inspected for any evidence of under cure or loss of pressure during curing; matrix cure tires should be inspected for tread rubber light spots and element porosity. Review initial inspector's comments for any items noted upon first inspection.

After inspection, the retreaded tire must be branded with the retread manufacturer's tire identification number (TIN). This number should be placed as close as possible to the original casing DOT number and any other previous retread tire identification numbers.

## Outfitting with Retreads

For the end user to appropriately select the proper tread for a truck tire, they must consider the application and service conditions in which the retreaded tire will be used.

### Matching of Retreads

Matching retreads is an important step to insure a long service life free of irregular wear, uneven tire loading, and premature removal. When choosing retread tires for dual applications one must know the diameter, construction, and vehicle/trailer type.

Inflation and diameter differences will have similar effects as under inflated or over loaded tires. Care must be taken to have equal inflations between dual assemblies and within 1/4" diameter difference. A difference of greater than 1/4" diameter will result in the larger tire carrying as much as 600 pounds more than the smaller tire. As diameter difference increases, the amount of load the larger tire is subjected to will increase. Such differences will reduce tread wear and service life.

Drive and twin-screw/tandem tires should be matched within 1/4" diameter across the axles. Failure to do so may result in:

- Loss of traction
- Internal damage to the differential and/or transmission
- Retread service life shortfalls from damage to the casing or irregular wear

Trailing and free rolling axles should be mated within 1/4" side by side and 1/4" diameter across the axle to maximize retread life and tread wear.

Matching tires by size can be achieved with:

- Tire caliper or dual tire measuring devices to measure the diameter of the tires once mounted
- Measuring device that is handheld or wall mounted to measure the inflated diameter

In either case, write the diameter measurement somewhere on the assembly as a quick reference for matching tires.

### Mixing Different Tire Casings Across Axles

Ideally, all of the casings and tread designs on an axle should be the same. As long as the overall diameters are within 1/4" it may be acceptable to mix casings or different tread designs on an axle. However, traction and tread wear can be affected.

### Mixing Tire Constructions

Radial and non-radial tires, different sizes or constructions should never be matched on the same axle.

## Regrooving

Regrooving is the process of cutting into the tread of a worn tire to create grooves that are at a depth equal to or deeper than the original molded groove depth. The process is typically done in the major grooves between the ribs of the original tread or the retread as in Figure 60.



**FIGURE 60: Regrooved Tire Tread Edges**

Although regrooving can extend the service of some tires used in certain applications, there are many rules, limitations, and regulations to follow. Differences in tire casing and tread designs may require differences in the regrooving process from tire to tire that increases complexity. Therefore, in addition to federal and state regulations, the regroover must determine and comply with any tire manufacturer recommendations for each size and type of tire.

Federal and state authorities can remove from service a vehicle with regrooved tires that fail to comply with regulations. In addition, there may be civil penalties under

federal or state law for selling or offering for sale regrooved tires in violation of laws.

Rules and regulations for regrooving include the following:

- Only tires that are marked "regroovable" on the sidewall by the original tire manufacturer may be regrooved.
- No cord material may be damaged or exposed.
- No cracks or wear may extend to any fabric or cord material. There should be no evidence of any separation.
- There must be at least 3/32" of tread material in the grooves (sometimes referred to as undertread) covering the outermost cord material.
- New grooves must be no less than 3/16" wide and no more than 5/16" wide.
- The new grooves, and any of the original molded grooves at or below the depth of the regrooved depth, must have a minimum of 90 linear inches of tread edges per linear foot of the tire circumference.
- All new grooves must have an unobstructed path for fluid to escape.

The above is not all-inclusive. It is the responsibility of the regroover to seek and follow the applicable regulations (see below) and tire manufacturer recommendations for regrooving tires.

**Additional Considerations** - The following tire service and retreadability factors should be considered when regrooving:

- It may be difficult to determine if there is enough undertread to properly regroove a tire and ensure 3/32" of tread rubber coverage. Contact the new tire manufacturer for the original undertread gauge or the retreader, if previously retreaded, for undertread depth specifications and recommendations to determine adequate coverage.
- Regrooving results in less tread rubber protection of the outermost belt/ply and may be more susceptible to damage (such as from road hazards, impacts, and penetrations). The new grooves may also be more susceptible to cracking. These situations may cause increased damage and lead to tire failure (such as by tread/belt separation), difficulty in retreading, or require the casing to be scrapped.
- Regrooved tires may be more difficult to retread, particularly in preparing the casing due to increased sensitivity in the buffing process, the need to remove a protector ply, or more extensive repairing.

**DOT FMCSA Regulations** - Federal Motor Carrier Safety Administration (FMCSA) regulations restrict the use of regrooved tires in certain applications. All buses and most medium/heavy trucks and truck tractors are not permitted to have regrooved tires applied to the front axle. For the specific Federal regulations, refer to the United States Code of Federal Regulations, Title 49, Part 393.75. As of October 2015, the portion of this regulation that applies to regrooved tires is as follows:

- 49 CFR § 393.75 (d) No bus shall be operated with regrooved, recapped or retreaded tires on the front wheels.
- 49 CFR § 393.75 (e) A regrooved tire with a load-carrying capacity equal to or greater than 2,232 kg (4,920 pounds) shall not be used on the front wheels of any truck or truck tractor.

**DOT NHTSA Regulations** - National Highway Traffic Safety Administration (NHTSA) regulations address regrooved tires in the United States Code of Federal Regulations, Title 49, Part 569. This part sets forth the conditions under which regrooved and regroovable tires manufactured or regrooved after the effective date of the regulation may be sold, offered for sale, introduced for sale or delivered for introduction into interstate commerce.



## Overview

This chapter provides information on demounting and mounting of truck and bus tires. The general guidelines include the following:

- Only properly trained tire service professionals should mount or demount a tire
- Select the proper tire and wheel components and make sure they are in good condition
- Tires should be the right size, type, load capacity and speed capability for the application
- For single piece wheels, select the proper size and type for the application and the proper wheel components such as valves
- For multi-piece wheels, select the proper matching components in size, type and application along with the proper tube and flap
- Have the proper tools and equipment
- Follow the detailed procedures provided by OSHA

Tubeless and tube-type tires are addressed in this chapter as well as servicing single-piece and multi-piece wheels/rims. USTMA guidelines regarding mounting and demounting tires are included. The U.S. Department of Labor Occupational Safety and Health Administration (OSHA) provides step-by-step procedures in wall charts and in manual form. The OSHA manual is included in its entirety beginning on p. 59. For specific OSHA procedures, see:

- Demounting and Mounting Procedures for Tubeless Truck and Bus Tires
- Demounting and Mounting Procedures for Tube-Type Truck and Bus Tires
- Multi-Piece Rim Matching Chart

## **⚠ WARNING**

Tire changing can be dangerous and should be done by trained personnel using proper tools and procedures. Always read and understand any manufacturer's warnings contained in owner's manuals, on the equipment, listed on websites and molded onto tire sidewalls.

Failure to comply with these procedures may result in faulty positioning of the tire and/or rim parts and cause the assembly to burst with explosive force sufficient to cause serious physical injury or death. Never mount or use damaged tires or rims.

For more on tire mounting safety and procedures refer to the following wall charts:

- OSHA "Demounting and Mounting Procedures for Tubeless Truck and Bus Tires"
- OSHA "Demounting and Mounting Procedures for Tube-Type Truck and Bus Tires"
- OSHA "Multi-Piece Rim Matching Chart"

## **⚠ WARNING**

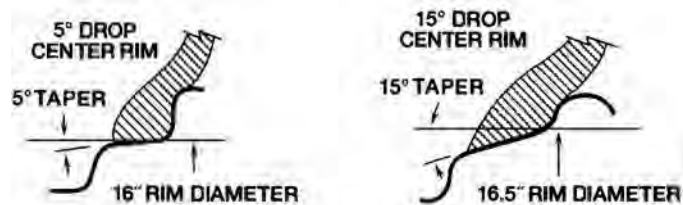
Serious injury or death may result from explosion of tire and rim/wheel assembly due to improper mounting.

- Never exceed 40 psi (inflation pressure) when seating beads.
- Always use a safety cage or other restraining device with a clip-on extension hose.
- Only specially trained persons should mount tires.

## ⚠ WARNING

There is a danger of serious injury or death if a tire of one bead diameter is installed on a rim or wheel of a different rim diameter. Always replace a tire with another tire of exactly the same bead diameter as the diameter of the rim on which it will be mounted.

For example: a 16" tire goes on a 16" rim. Never mount a 16" tire on a 16.5" rim. A 16.5" tire goes on a 16.5" rim. Never mount a 16.5" tire on a 16" rim. While it is possible to pass a 16" diameter tire over the lip or flange of a 16.5" size diameter rim, it cannot be inflated enough to position itself against the rim flange. If an attempt is made to seat the tire bead by inflating, the tire bead will break with explosive force and could cause serious injury or death. Rims of different diameters and tapers cannot be interchanged. The following diagram illustrates the difference between rims of two different tapers and diameters:



The following diagram shows how beads of a 16" tire will not seat on a 16.5" rim. The beads cannot be forced out against the rim flanges by using more inflation pressure because this will break the beads and the tire will explode with force sufficient to cause serious injury or death.



### Tire Selection

Tires should be the right size, type, load capacity and speed capability for the application. See Chapter 3, "Tire Application and Replacement Guidelines" on p. 32.

Always inspect the inside and outside of a tire for injuries or damage. This applies to all tires regardless of whether they have been previously used; for instance, new tires may be damaged from shipping or handling. Do not mount a tire with an unserviceable condition. See Chapter 2, "Tire Care and Service" on p. 8.

Assemble components that are compatible with each other and match in size. For example, the tire must have exactly the same bead diameter as the diameter of the rim on which it will be mounted.

### Lubricants, Mounting Aids and Bead Sealers

Always lubricate with approved, commercially available tire mounting lubricants made for bead seating. Also, vegetable oil and soap solutions may be used. If a lubricant is water-based, it should contain a rust inhibitor. Care should be

exercised to avoid application of excessive lubricant to minimize moisture in the pressure chamber. Do not allow any lubricant to run between the tube and casing in tube-type tires or on the inside surface of tubeless tires. When dry, the lubricant should not remain slippery.

Some mounting aids (such as rubber O-rings or "donuts") can become trapped between the tire bead and rim during mounting. This prevents the bead from properly seating on the rim. If the bead does not seat because the mounting aid is trapped, completely deflate the assembly, then determine and correct the cause. Never inflate beyond 40 psi to seat beads.

Bead sealers may also impede bead seating if applied improperly on beads and rim contact surfaces. If the bead does not seat, completely deflate the assembly then determine and correct the cause. Never inflate beyond 40 psi to seat beads.

## ⚠ WARNING

Silicone, petroleum, or solvent-based lubricants must not be used. These substances may:

- cause the tire to slip on the rim
- have a harmful effect on the tire, tube, flap and/or rim
- create explosive mixtures of air and vapors in the tire which may result in serious injury or death

## Tire Explosions and Flammable Substances

Inflation pressure in a tire represents tremendous potential energy. If improperly treated, a tire can explode, suddenly releasing the stored-up energy which may result in serious injury or death. Causes for tire/wheel assembly explosions can include:

- Tire damaged during mounting/demounting
- Tire mounted on the wrong size rim
- Improper mounting/demounting procedures
- Use of flammable solvents during tire mounting or to seat beads
- Exceeding the maximum pressure limitation of the tire
- Flammable liquids or vapors introduced into the tire including sealants and aerosol inflators
- Welding, heating, or brazing an inflated tire/wheel assembly
- Improper tube fitment and pinching of the tube between the rim and tire during inflation
- Re-inflating a tire which has been run in an under inflated or over loaded condition
- Tire damaged in service or improperly repaired and reinflated
- Brake overheating
- Exceeding the maximum pressure limitation of the rim

## ⚠ WARNING

Serious injury or death may result from an explosion of the tire and rim/wheel assembly due to heating the rim/wheel. Never rework, weld, braze or heat a wheel or rim.

## ⚠ WARNING

Never, under any circumstance, introduce a flammable substance into a tire.

Igniting this substance in an effort to facilitate seating the beads is extremely unsafe. This may result in an explosion of the tire with force sufficient to cause serious personal injury or death.

This practice may also result in undetected damage to the tire or rim that could result in failure of the tire in service.

## ⚠ WARNING

### TIRE SEALANTS AND BALANCING SUBSTANCES

Solvent-based liquids must not be used due to the possibility of creating explosive mixtures of vapors in the tire, which may result in serious injury or death.

Avoid flammable vapors inadvertently being pumped into a tire when the tire is inflated.

- Do not use alcohol, methanol, dry gas or any other flammable material in the compressor tank to prevent freezing or condensation
- Do not store flammable solvents or rubber cements near the intake of the compressor
- Do not clean the compressor intake screen/filter with flammable solvents such as gasoline
- Do not use a battery charger near the compressor intake. This can result in hydrogen gas being drawn into the compressor

Locate compressor indoors where freezing will not occur and in an area by itself away from operations such as tire repairing, battery charging, etc. Each day, open the bleed valve on the tank to expel moisture. Add a filter, trap, or dryer to the compressor to remove moisture.

## Aftermarket Sealants/Inflators

Flammable propellants and/or liquids in aftermarket sealants or aerosol inflators may cause a tire to explode under certain circumstances. Never introduce a flammable substance into a tire. Tire service professionals should assume that any aftermarket product used to seal or inflate a tire is flammable. In addition to following proper demounting procedures (see p. 58), take the following precautions:

- Keep the tire away from heat, flame, sparks or other ignition sources
- Use tools with caution, particularly tire irons, reamers and hammers, to avoid causing sparks
- Remove the valve core and completely deflate the tire in a well-ventilated area with the tire secured to a vehicle, tire mounting machine or other restraining device. Reinflate and deflate the tire a few times to further dissipate and expel potentially flammable vapor

The USTMA does not endorse any type of tire sealants or tire balancing products. Only products that have been determined to have no damaging or harmful effect on the tire, tube, flap, valve assembly and/or rim may be used.

## Valves and Caps

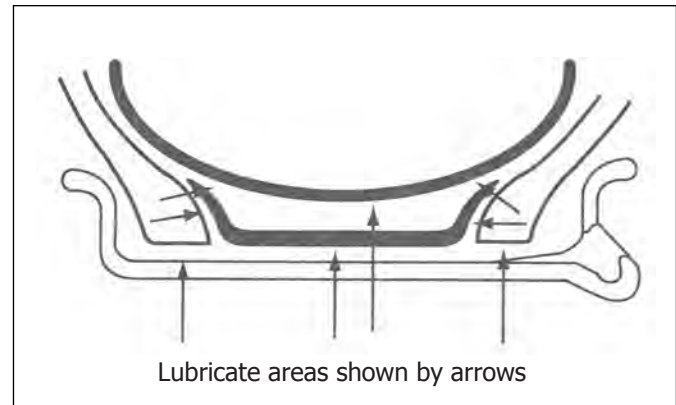
1. Always inspect the valves and valve cores for proper air retention. Be sure the valve is suitable for the operating pressure and service conditions. Replace corroded or damaged valves or valve cores.
2. Always cover the valve stem with a metal, high-temperature sealing cap. This helps prevent moisture, dirt and other contaminants from entering the valve core as well as providing an additional seal. The proper valve must be used for the particular tire/wheel application.
3. Valve, tire and wheel manufacturers recommend that valve stems be removed, inspected and/or replaced before tires are mounted. At a minimum, the grommet or O-ring should be replaced. The same heat resistant type grommet or O-ring should be used as the original grommet. When installing a valve stem, always check the rim hole for nicks, burrs or corrosion.
4. Valve extensions, dual tire pressure equalizers, and on-vehicle tire inflation systems require high-temperature seals and a metal, high-temperature sealing caps and/or fittings.
5. Tire/wheel assemblies that are equipped with a tire pressure monitoring system (TPMS) may have a sensor that is attached to or is part of the valve assembly. When new tires are installed, it is recommended to also replace all components that are included in the TPMS valve replacement kit. In addition, whenever the sensor is disassembled for any reason, install a new TPMS replacement kit. Always replace any damaged sensor.

### NOTE

If a TPMS sensor is removed, the TPMS will not function.

## Tubes and Flaps

1. Always use a new tube and a new flap in a new tube-type tire and a newly retreaded tube-type tire.
2. Always use the proper size tube and flap for the tire and rim.
3. Always check to ensure the new tube is clean and dry on the outside before installing it in the tire.
4. Never install tubes or flaps that are buckled, creased or hardened.



**FIGURE 61: Tire, Tube, Flap and Rim**

Figure 61 shows how the tire, tube, flap and rim components fit together correctly. Damage to the tire or tube may result from improper fitment, particularly if a flap is reused. A flap in serviceable condition must be remounted in the same size tire and on the same size rim from which it was previously used. As a precaution against flap failure, mark the tire and rim size on the flap at the time of removal (if inspection shows it is not damaged and can be used again). This marking prevents use of the flap with the wrong size tire and rim. Do not reuse flaps which have become twisted, creased, folded over at the edges, or hardened.

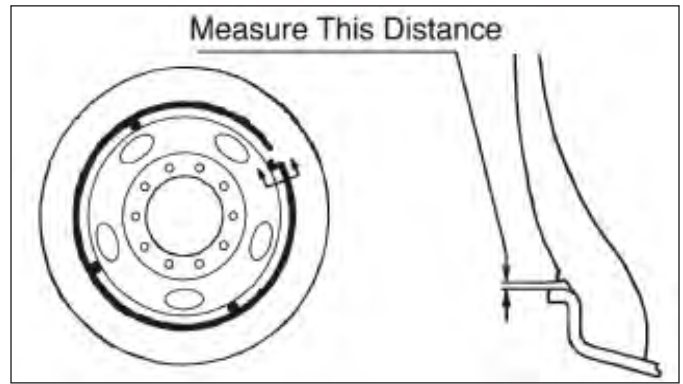
A plastic valve cap that sometimes comes on a new truck tire tube is not intended for use in service. Its purpose is to keep dust and dirt out of the stem during shipment, protect the threads of the stem, and shield the folded tube against abrasion by the threads. Always cover the valve stem with a metal, high-temperature sealing cap.

Bend the valve stem to its proper position. If it touches the rim, brake drum or any other component, the valve cap will be difficult to remove, and inflation pressure checks will be hindered. Contact with components may also cause heat to be conducted to the tube/flap and cause damage leading to valve or tube failure.

After mounting the tire, but before inflating, inspect all components of multi-piece rims to make sure that they are matched and seated.

## Tire and Rim Centering

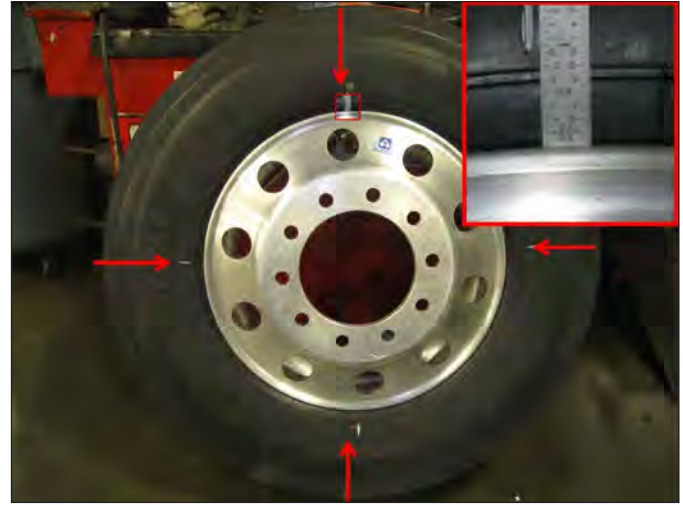
Once the tire is mounted and inflated according to OSHA procedures, check the distance between the tire mounting-guide ring and the rim flange. The distance should be the same all the way around the tire, varying no more than 2/32 inch. In other words, the rim flange is concentric with the mounting-guide ring and the distance is the same on both sides of the tire. Measure in at least four locations as in Figure 62. Lack of tire and rim centering may create ride discomfort and irregular wear. Consult the tire or wheel manufacturer for more information.



### ⚠ WARNING

Any tire suspected of operating under inflated and/or over loaded must be approached with caution. Permanent damage due to operating a tire under inflated and/or over loaded cannot always be detected. Any tire known or suspected of being operated at 80 percent or less of normal operating inflation pressure and/or over loaded could possibly have permanent sidewall structural damage (steel cord fatigue).

Ply cords weakened by under inflation and/or over loading may break one after another, until a rupture occurs in the upper sidewall with accompanying instantaneous air loss and explosive force. This can result in serious injury or death.



**FIGURE 62: Use of Mounting Guide Ring to Indicate Concentric Mounting**

### ⚠ WARNING

IF YOU DO NOT KNOW HOW TO USE TIRE SERVICING TOOLS — STOP! TIRE SERVICING MUST ONLY BE PERFORMED BY TRAINED PERSONNEL. FAILURE TO FOLLOW PROPER PROCEDURES CAN RESULT IN SERIOUS INJURY OR DEATH.

ALWAYS wear adequate protective eyewear (or face shield), protective footwear, and ear protection while servicing tires to avoid injury.

- NEVER use a tire tool for anything except demounting and mounting tires.
- NEVER use an extension or "cheater" bar with tire irons.
- ALWAYS use soft-faced hammers when driving tire irons or assembling components.
- NEVER use a hammer with a loose or cracked handle.
- NEVER use a bent, cracked, chipped, dented or mushroomed tool. Keep tools clean and inspect them frequently.
- NEVER alter or apply heat to any tire service tool.



## **⚠WARNING**

NEVER INFLATE BEYOND 40 PSI TO SEAT BEADS.

NEVER STAND, LEAN, OR REACH OVER THE ASSEMBLY DURING INFLATION.

Inspect both sides of the tire to be sure that the beads are evenly seated. Inflation should be done in a safety cage or other restraining device. If both beads are not properly seated when pressure reaches 40 psi, completely deflate the assembly, reposition the tire and/or tube on the rim, relubricate, and reinflate.

Inflating beyond 40 psi inflation pressure when trying to seat the beads is a **DANGEROUS PRACTICE** that may break a tire bead (or even the rim) with explosive force, possibly resulting in serious injury or death. After the beads are fully seated, pressure may be increased above 40 psi to operating pressures, as shown on the vehicle placard but not to exceed the maximum molded on the tire sidewall.

### **Inflating Truck/Bus Tires**

Never inflate a tire unless it is secured to a vehicle, tire mounting machine or other restraining device such as a safety cage. Use a remote inflation device with a clip-on chuck standing away from the tire as shown in Figures 63, 64 and 65.

For information on tire inflation pressure specifications and maintenance, see "Proper Tire Information" on p. 9.



**FIGURE 63: Inflating in the Shop**



**FIGURE 64: Inflating in Portable Safety Cage**



**FIGURE 65: Inflating the Vehicle**

**SERVICING MULTI-PIECE AND SINGLE-PIECE RIM WHEELS  
29 CFR 1910.177**

**DEMOUNTING AND  
MOUNTING PROCEDURES  
FOR **TUBELESS** TRUCK  
AND BUS TIRES**

**DEMOUNTING AND  
MOUNTING PROCEDURES  
FOR **TUBE-TYPE** TRUCK  
AND BUS TIRES**

****MULTI-PIECE RIM**  
MATCHING CHART**



**Occupational Safety  
and Health Administration**

U.S. Department of Labor

[www.osha.gov](http://www.osha.gov)

OSHA 3421-10R 2014

**SERVICING MULTI-PIECE AND SINGLE-PIECE RIM WHEELS**  
**29 CFR 1910.177**

**DEMOUNTING AND  
MOUNTING PROCEDURES  
FOR **TUBELESS** TRUCK  
AND BUS TIRES**

**DEMOUNTING AND  
MOUNTING PROCEDURES  
FOR **TUBE-TYPE** TRUCK  
AND BUS TIRES**

**MULTI-PIECE RIM  
MATCHING CHART**



**Occupational Safety  
and Health Administration**

U.S. Department of Labor

**[www.osha.gov](http://www.osha.gov)**

OSHA 3421-10R 2014



## CONTENT

### CHART 1

#### DEMOUNTING AND MOUNTING PROCEDURES

#### FOR **TUBELESS** TRUCK AND BUS TIRES.....1

**1** BEFORE SERVICING ANY TIRE RIM/WHEEL ASSEMBLY.....2

**2** DEFLATING AND DEMOUNTING TIRE FROM RIM/WHEEL ASSEMBLY.....3

**3** INSPECTING TIRE AND RIM/WHEEL COMPONENTS.....4

**4** MOUNTING TIRE ON RIM/WHEEL ASSEMBLY.....5

**5** INFLATING TIRE RIM/WHEEL ASSEMBLY.....6

### CHART 2

#### DEMOUNTING AND MOUNTING PROCEDURES

#### FOR **TUBE-TYPE** TRUCK AND BUS TIRES.....8

**1** BEFORE SERVICING ANY TIRE RIM/WHEEL ASSEMBLY.....9

**2** DEFLATING AND DEMOUNTING TIRE FROM RIM/WHEEL ASSEMBLY.....10

**3** INSPECTING TIRE AND RIM/WHEEL COMPONENTS.....11

**4** MOUNTING TIRE ON RIM/WHEEL ASSEMBLY.....12

**5** INFLATING TIRE RIM/WHEEL ASSEMBLY.....13

### CHART 3

#### **MULTI-PIECE RIM** MATCHING CHART.....15

# DEMOUNTING AND MOUNTING PROCEDURES FOR **TUBELESS** TRUCK AND BUS TIRES

 **WARNING**

**TIRE AND RIM SERVICING CAN BE DANGEROUS  
AND MUST ONLY BE PERFORMED BY  
TRAINED PERSONNEL USING PROPER  
PROCEDURES AND TOOLS.**

 **WARNING**

**FAILURE TO READ AND COMPLY WITH ALL OF  
THESE PROCEDURES MAY RESULT IN SERIOUS  
INJURY OR DEATH TO YOU AND OTHERS.**

## PLEASE NOTE:

THIS IS CHART 1 OF A 3-CHART SET. BE SURE TO ALSO READ,  
UNDERSTAND AND COMPLY WITH CHART 2 RE: DEMOUNTING AND MOUNTING  
PROCEDURES FOR TUBE-TYPE TRUCK AND BUS TIRES, AND  
CHART 3 RE: MULTI-PIECE RIM MATCHING

 **WARNING**

Completely deflate any tire by removing the valve core before removing the tire/wheel assembly from the axle if there is known or suspected damage to the tire or wheel or if the tire has been operated at 80% or less of its recommended operating pressure. Demount, inspect and match all tire and rim parts before re-inflating in a restraining device.

**NEVER** use starter fluid, ether, gasoline, or other flammable materials and/or accelerants to lubricate the beads of a tire. This practice can cause the explosive separation of the tire/wheel during servicing or during highway use, which may result in serious injury or death.

**NEVER** inflate beyond 40 psi to seat any tire beads. **NEVER** stand, lean, or reach over the tire rim/wheel assembly in the restraining device during inflation. Even if a tire is in a restraining device, inflating beyond 40 psi when trying to seat the beads is a **DANGEROUS PRACTICE** that may break a tire bead or the rim/wheel with explosive force and possibly result in serious injury or death.

Any inflated tire mounted on a wheel contains explosive energy. The use of damaged, mismatched or improperly assembled tire and wheel components can cause the assembly to separate with explosive force. If struck by an exploding tire, wheel component, or the air blast, you or someone else may be seriously injured or killed.

Mismatching tire and rim diameters is dangerous. A mismatched tire and rim assembly may separate and can result in serious injury or death. This warning applies to 15" and 15.5", 16" and 16.5", 18" and 18.5", 22" and 22.5", 24" and 24.5" tire and rim assemblies as well as other sized assemblies. **NEVER** assemble a tire and rim unless you have positively identified and correctly matched the tire and rim diameter.

**NEVER** assemble a tire and rim unless you have positively identified and correctly matched the tire and rim diameter. If an attempt is made to seat the tire bead by inflating on a mismatched rim/wheel, the tire bead will break with explosive force and may result in serious injury or death.

# 1

## BEFORE SERVICING ANY TIRE RIM/WHEEL ASSEMBLY

- **ALWAYS** comply with the procedures on this chart and in the tire/wheel manufacturer's catalogs, instruction manuals or other industry and government instructional materials.
- **Use a non-flammable vegetable or soap-based rubber lubricant** on the beads and rim surfaces to make tire demounting and mounting easier.
- **Use proper tools to demount or mount tires and rims** (refer to "Typical Tire Service Tools"). **NEVER** strike the tire/wheel assembly with a steel duck bill hammer to unseat the beads and do not strike the head of the hammer with another hard-faced hammer – use a rubber mallet or plastic dead blow hammer. Slide impact bead unseating tools are the preferred tools for unseating beads on tubeless tires.
- **NEVER** reinflate any tire that has been operated in a run-flat or underinflated condition (i.e., operated at 80% or less of recommended operating pressure). Demount, inspect and match all tire and rim components before reinflating in a restraining device with the valve core removed.
- **If an emergency puncture repair inflater was used on a tubeless tire**, deflate and inflate the tire several times to remove potentially explosive propellant before servicing the tire.

### **WARNING**

**IF YOU DO NOT KNOW HOW TO USE TIRE SERVICING TOOLS — STOP!  
TIRE SERVICING MUST ONLY BE PERFORMED BY TRAINED PERSONNEL.  
FAILURE TO FOLLOW PROPER PROCEDURES CAN RESULT IN SERIOUS INJURY OR DEATH.**

- **ALWAYS** wear adequate protective eyewear (or face shield), protective footwear, and ear protection while servicing tires to avoid injury.
- **NEVER** use a tire tool for anything except demounting and mounting tires.
- **NEVER** use an extension or "cheater" bar with tire irons.
- **ALWAYS** use soft-faced hammers when driving tire irons or assembling components.
- **NEVER** use a hammer with a loose or cracked handle.
- **NEVER** use a bent, cracked, chipped, dented or mushroomed tool. Keep tools clean and inspect them frequently.
- **NEVER** alter or apply heat to any tire service tool.

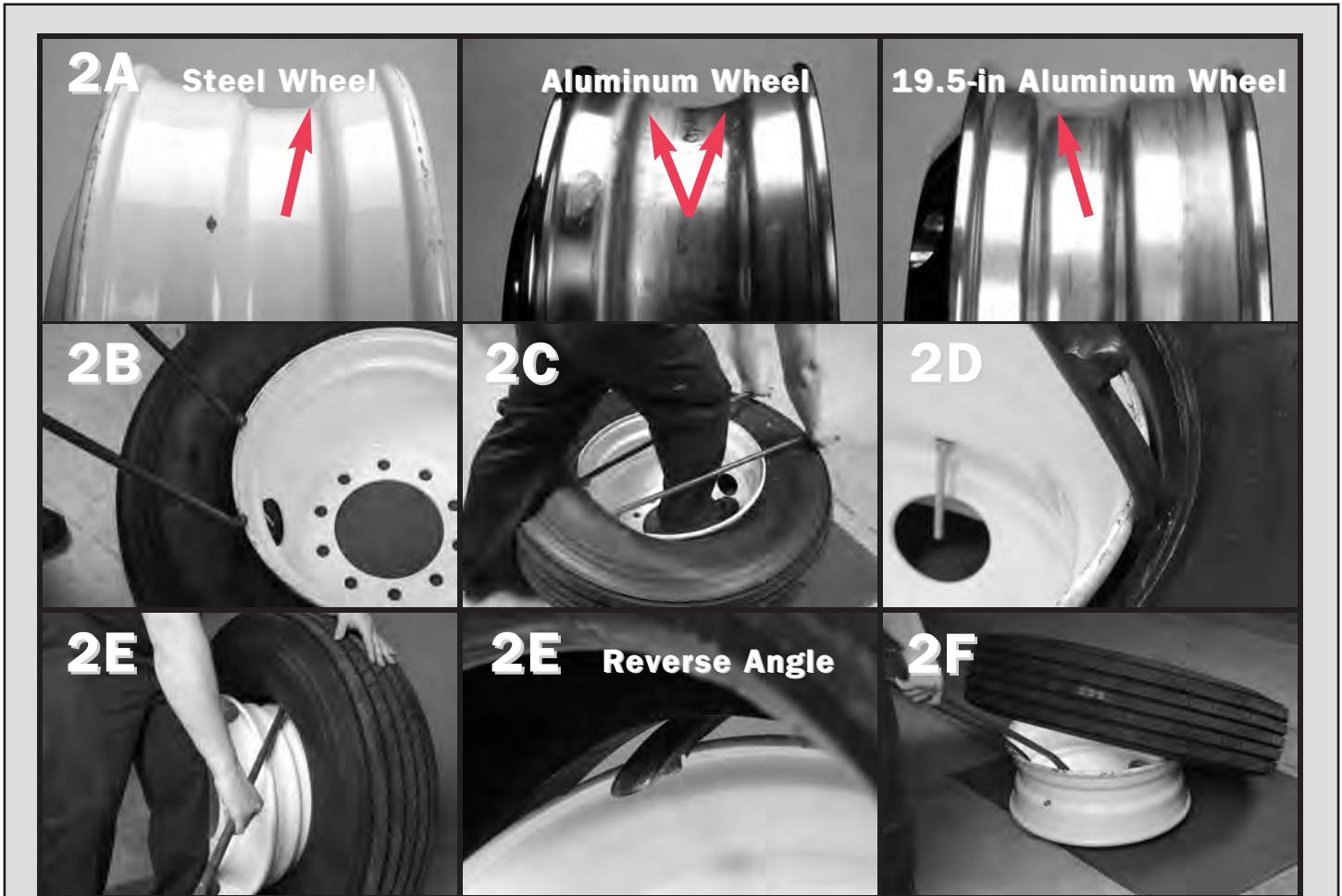


# 2

## DEFLATING AND DEMOUNTING TIRE FROM RIM/WHEEL ASSEMBLY

- **ALWAYS completely deflate** the tire assembly before attempting to demount. Remove the valve core and insert a wire down the valve stem to ensure complete deflation. **NEVER** demount a tire from a rim unless you are sure it is completely deflated.
- **Loosen beads** by using a slide impact bead unseating tool, duck bill hammer with a rubber mallet, or other bead unseating tools. Both beads must be loosened before demounting a tire.

### TUBELESS; SINGLE PIECE



**2A. Identify the short side of the drop center wheel well.** Single piece tubeless rims and wheels must be demounted from the short side of the drop center well. On steel disc wheels, the short side is typically located opposite the disc. Aluminum wheels typically have symmetrical drop centers so tires can be demounted from either side. However, on certain 19.5-inch aluminum wheels, the short side of the drop center well is located on the disc side.

**2B. Unseat and lubricate both beads.** Position the assembly with the short side of the drop center well facing up.

**2C. Insert tire irons** on either side of the valve stem approximately 6 inches (152 mm) apart. Pry the top bead over the rim flange and force the bead opposite the tire irons in the drop center well.

**2D. Remove one tire iron and insert the curved end between the bead and rim.** Pry the rest of the top bead over the rim flange. Repeat this process until the first bead is entirely free from the rim.

**2E. Stand the tire on its tread.** Slide the flat end of the tire iron between the bead and the rim flange; make sure the tip is completely over the rim flange. Remove solid flange.

**2F. Pry the tire iron and allow the rim/wheel to drop.** **IMPORTANT!** Make sure your feet are clear of the rim. If necessary, rock or bounce the assembly to remove the tire from the rim/wheel. For aluminum wheels, a rubber mat should be placed on the floor to prevent damage to the mounting surface of the wheel.

# 3

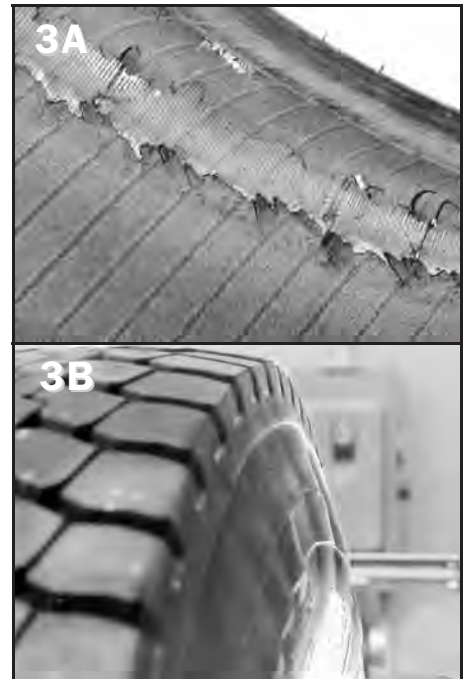
## INSPECTING TIRE AND RIM/WHEEL COMPONENTS

- **ALWAYS** conduct a visual and tactile inspection of the tire.
- **LOOK** and **FEEL** for any damage or evidence of being operated overloaded and/or in a run-flat condition (80% or less of its recommended operating inflation pressure).

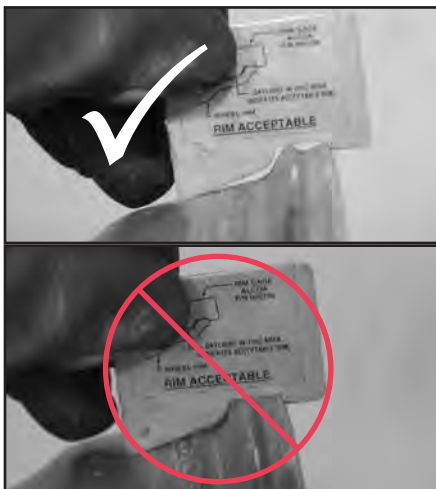
Photo 3A is an example of innerliner damage created by an underinflated and overloaded condition.

**⚠ WARNING** Radial tires that have undulations or irregular sidewall distortions could possibly have permanent sidewall structural damage (steel cord fatigue). Ply cords weakened by underinflation and/or overloading may break one after another, until a rupture occurs in the upper sidewall with accompanying instantaneous air loss and explosive force. This can result in serious injury or death. Follow tire industry recommended inspection procedures for tires with these characteristics. Photo 3B is an example of sidewall undulations indicative of a potential “zipper rupture”.

- Remove rust, dirt, or foreign material from all tire and rim/wheel mating surfaces.
- Inspect rim/wheel. **NEVER** use any single-piece rims/wheels that are worn, bent, cracked, or pitted by corrosion. Clearly mark and remove all unserviceable parts from the service area. See examples in 3C and 3D.
- **DO NOT** rework, weld, heat or braze any rim parts or components for any reason.



**3C** In the examples below, a rim flange wear guage can be used to determine if the rim flange is acceptable for service. The guage reads “Daylight in this area is an acceptable rim.”



**3D** Use a carpenter square and a credit card to examine rim diameter.



By using the carpenter square and the credit card on this wheel, it is more clear that the rim diameter has been reduced so the wheel should not be used. See WARNING below.



**⚠ WARNING**

ANY INFLATED TIRE MOUNTED ON A WHEEL CONTAINS EXPLOSIVE ENERGY. THE USE OF DAMAGED, MISMATCHED OR IMPROPERLY ASSEMBLED TIRE AND WHEEL COMPONENTS CAN CAUSE THE ASSEMBLY TO SEPARATE WITH EXPLOSIVE FORCE. IF STRUCK BY AN EXPLODING TIRE, WHEEL COMPONENT, OR THE AIR BLAST, YOU OR SOMEONE ELSE MAY BE SERIOUSLY INJURED OR KILLED.

# 4

## MOUNTING TIRE ON RIM/WHEEL ASSEMBLY

### TUBELESS; SINGLE-PIECE

**4A. Before mounting, be sure that the tire is properly matched to the rim.** These photo examples show the rim/wheel size stamp.

**⚠ WARNING NEVER** assemble a tire and rim unless you have positively identified and correctly matched the tire and rim diameter. If an attempt is made to seat the tire bead by inflating on a mismatched rim/wheel, the tire bead will break with explosive force and may result in serious injury or death.

**4B. Identify the short side of the drop center well.** Single-piece tubeless rims and wheels must be mounted from the short side of the drop center well. On steel disc wheels, the short side is typically located opposite the disc. Aluminum wheels typically have symmetrical drop centers so tires can be mounted from

either side. However, on certain 19.5-inch aluminum wheels, the short side of the drop center well is located on the disc side.

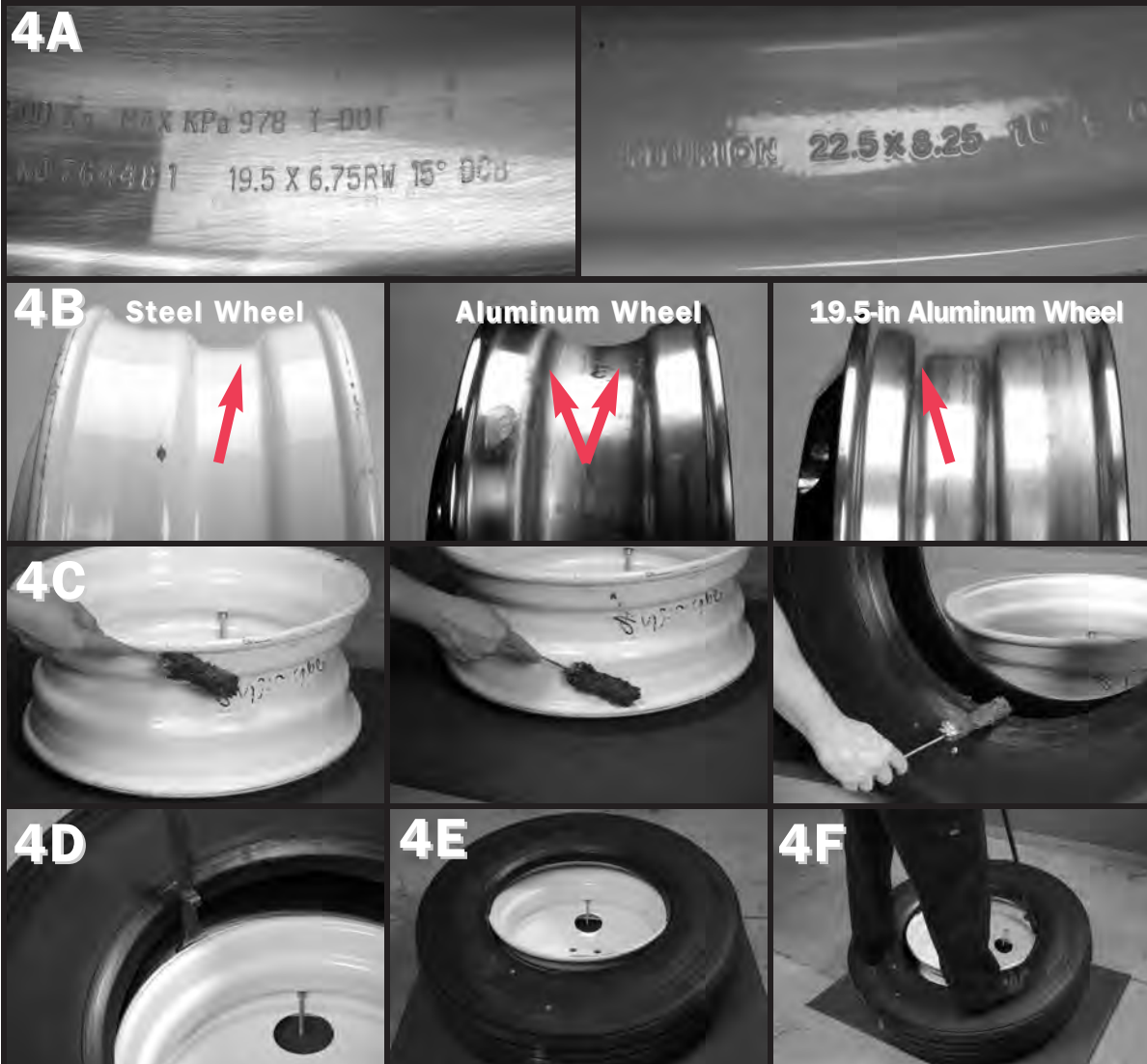
**4C. Place the wheel on the floor** with the short side of the drop center well facing up. **Lubricate** the tire beads and rim surfaces.

**4D. Push the tire on the rim** opposite the valve stem and use the curved end of the tire iron to pry the bottom bead over the rim flange.

**4E. Apply pressure** to the bead opposite the valve stem making sure the bead is completely in the drop center well.

**4F. Taking small bites, use the curved end of the tire iron to pry the top bead over the rim flange.** Keep the bead in the drop center well with your foot or a bead-locking device. Continue until the top bead is fully mounted over the rim flange.

**BEFORE INFLATING TIRE RIM/WHEEL ASSEMBLY, THE TIRE MUST BE PROPERLY MOUNTED.**



# 5

## INFLATING TIRE RIM/WHEEL ASSEMBLY

### ⚠️ WARNING

TIRE AND RIM SERVICING CAN BE DANGEROUS AND MUST ONLY BE PERFORMED BY TRAINED PERSONNEL USING PROPER PROCEDURES AND TOOLS. FAILURE TO READ AND COMPLY WITH ALL OF THESE PROCEDURES MAY RESULT IN SERIOUS INJURY OR DEATH TO YOU AND OTHERS.

**⚠️ WARNING NEVER** use starter fluid, ether, gasoline, or other flammable materials and/or accelerants to lubricate or to seat the beads of a tire. This practice can cause the explosive separation of the tire/wheel during servicing or during highway use, which may result in serious injury or death.

**⚠️ WARNING ALWAYS** inflate the tire rim/wheel assembly in a restraining device with the valve core removed. The air line assembly must consist of the following components: a clip-on air chuck, an in-line valve with a pressure gauge or presettable regulator, and sufficient hose length to keep the technician outside the trajectory during inflation. (See “Trajectory” WARNING below.) **DO NOT** rest or lean any part of your body against the restraining device during inflation. Failure to use a restraining device when inflating a tire rim/wheel assembly is not only a violation of OSHA regulation 1910.177, but also a DANGEROUS PRACTICE that may result in serious injury or death.

**⚠️ WARNING** During inflation, if ANY sidewall undulations or bulges appear or if ANY snapping, cracking or popping noises occur — **STOP! DO NOT** approach tire. Before removing from restraining device, completely deflate tire remotely. Remove clip-on air chuck. Mark tire as damaged for potential “zipper rupture”. Render tire unservicable, non-repairable and scrap.

**⚠️ WARNING NEVER** inflate beyond 40 psi to seat any tire beads. **NEVER** stand, lean, or reach over the tire rim/wheel assembly in the restraining device during inflation. Even if a tire is in a restraining device, inflating beyond 40 psi when trying to seat the beads is a DANGEROUS PRACTICE that may break a tire bead or the rim/wheel with explosive force and possibly result in serious injury or death.

### STEP-BY-STEP INFLATION PROCEDURES

**1. Before inflating any tire rim/wheel assembly**, be sure to read, understand and comply with ALL WARNINGS.  
**2.** After mounting the tire on the rim, use a compressed air tank with quick release valve to seal the beads. **Do not exceed 5 psi before placing the assembly in a restraining device.**

**3. Place the assembly in an OSHA-compliant restraining device**, such as a tire safety cage. Photo 5A is an example of one type of a restraining device. Manufacturers recommend that restraining devices be freestanding and located at least one foot away from any flat or solid surface.

**4. Inflate the tire, with the valve core removed**, using a clip-on air chuck with an in-line valve or pressure regulator and a sufficient length of hose. **Inflate to 20 psi** in restraining device. **IMPORTANT!** Look for distortions, undulations, or other irregularities in the tire sidewall, such as in Photo 5C. Listen for any popping or snapping sounds. If ANY of these conditions are present — **STOP! DO NOT** approach tire. Before removing from restraining device, completely deflate tire remotely. Remove clip-on air chuck. Mark tire as damaged for potential “zipper rupture”. Render tire unservicable, non-repairable and scrap.

**5. Visually inspect tire rim/wheel assemblies** throughout the inflation process for improper seating. When inflating a tire, stay out of the trajectory. See “Trajectory” WARNING below. **DO NOT** stand or lean any part of your body against, or reach over, the restraining device during inflation.



**6. Continue to inflate until the beads are seated on the rim/wheel.** Inspect both sides of the tire to be sure that the beads are evenly seated. **NEVER** inflate beyond 40 psi to seat any tire beads. If the beads are not seated at 40 psi — **STOP!** Completely deflate, remove from the restraining device, and determine the problem. Reposition the tire on the rim, relubricate, and reinflate.

**7. After the tire beads are seated, continue to inflate the tire** to its recommended inflation pressure. **IMPORTANT!** Look for distortions, undulations, or other irregularities in

the tire sidewall, such as in Photo 5D. Listen for any popping or snapping sounds. If ANY of these conditions are present — **STOP! DO NOT** approach tire. Before removing from restraining device, completely deflate tire remotely. Remove clip-on air chuck. Mark tire as damaged for potential “zipper rupture”. Render tire unservicable, non-repairable and scrap.

**8.** If none of these “zipper” conditions are present, **remove clip-on air chuck, install the valve core, and adjust the inflation pressure** to the recommended operating inflation pressure.

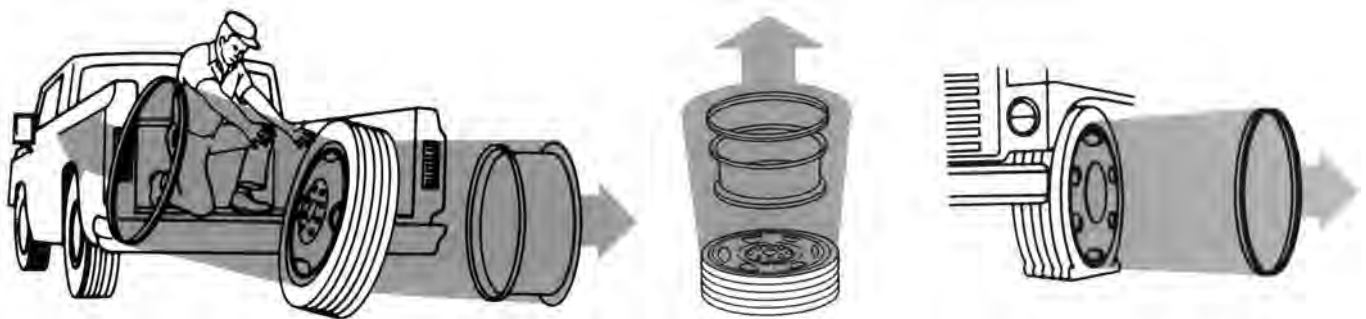
**9. Before removing** the tire rim/wheel assembly from the restraining device, always visually inspect for proper seating of the beads and all parts.

**10. Conduct a final inspection.** Check for air leaks. Install a suitable valve cap.

# **WARNING**

## **TRAJECTORY**

THE AIR PRESSURE CONTAINED IN A TIRE IS DANGEROUS. THE SUDDEN RELEASE OF THIS PRESSURE BY A TIRE BLOW-OUT OR SIDE RING SEPARATION CAN CAUSE SERIOUS INJURY OR DEATH. STAY OUT OF THE TRAJECTORY AS INDICATED BY THE SHADED AREA DEPICTED IN THE GRAPHICS. WHEN INSTALLING THE TIRE RIM/WHEEL ASSEMBLY ON THE VEHICLE, IT WILL BE IMPOSSIBLE TO STAY OUT OF THE TRAJECTORY. HOWEVER, AT ALL OTHER TIMES YOU AND ALL OTHERS MUST STAY OUT OF THE TRAJECTORY.



*NOTE: Under some circumstances, the trajectory may deviate from its expected path.*



**Occupational Safety  
and Health Administration**

U.S. Department of Labor

[www.osha.gov](http://www.osha.gov) • (800) 321-OSHA (6742) • TTY (877) 889-5627



# DEMOUNTING AND MOUNTING PROCEDURES FOR **TUBE-TYPE** TRUCK AND BUS TIRES

 **WARNING**

**TIRE AND RIM SERVICING CAN BE DANGEROUS  
AND MUST ONLY BE PERFORMED BY  
TRAINED PERSONNEL USING PROPER  
PROCEDURES AND TOOLS.**

 **WARNING**

**FAILURE TO READ AND COMPLY WITH ALL OF  
THESE PROCEDURES MAY RESULT IN SERIOUS  
INJURY OR DEATH TO YOU AND OTHERS.**

## PLEASE NOTE:

THIS IS CHART 2 OF A 3-CHART SET. BE SURE TO ALSO READ,  
UNDERSTAND AND COMPLY WITH CHART 1 RE: DEMOUNTING AND MOUNTING  
PROCEDURES FOR TUBELESS TRUCK AND BUS TIRES AND  
CHART 3 RE: MULTI-PIECE RIM MATCHING

 **WARNING**

Completely deflate any tire by removing the valve core before removing the tire/wheel assembly from the axle if there is known or suspected damage to the tire or wheel or if the tire has been operated at 80% or less of its recommended operating pressure. Demount, inspect and match all tire and rim parts before re-inflating in a restraining device.

**NEVER** use starter fluid, ether, gasoline, or other flammable materials and/or accelerants to lubricate the beads of a tire. This practice can cause the explosive separation of the tire/wheel during servicing or during highway use, which may result in serious injury or death.

**NEVER** inflate beyond 40 psi to seat any tire beads.  
**NEVER** stand, lean, or reach over the tire rim/wheel assembly in the restraining device during inflation. Even if a tire is in a restraining device, inflating beyond 40 psi when trying to seat the beads is a **DANGEROUS PRACTICE** that may break a tire bead or the rim/wheel with explosive force and possibly result in serious injury or death.

Any inflated tire mounted on a wheel contains explosive energy. The use of damaged, mismatched or improperly assembled tire and wheel components can cause the assembly to separate with explosive force. If struck by an exploding tire, wheel component, or the air blast, you or someone else may be seriously injured or killed.

Re-assembly and inflation of mismatched components on multi-piece tire and wheel assemblies can result in serious injury or death. Just because the components come in or fit together does not mean they are matched. Check the identification stamps for proper matching of all rim parts before assembling a multi-piece tire and wheel.

Mismatching tire and rim diameters is dangerous. A mismatched tire and rim assembly may separate and can result in serious injury or death. This warning applies to 15" and 15.5", 16" and 16.5", 18" and 18.5", 22" and 22.5", 24" and 24.5" tire and rim assemblies as well as other sized assemblies. **NEVER** assemble a tire and rim unless you have positively identified and correctly matched the tire and rim diameter.

# 1

## BEFORE SERVICING ANY TIRE RIM/WHEEL ASSEMBLY

- **ALWAYS** comply with the procedures on this chart and in the tire/wheel manufacturer's catalogs, instruction manuals or other industry and government instructional materials.
- **Before loosening any nuts or clamps** that attach a tube-type tire/rim assembly to a vehicle, **ALWAYS** completely deflate the tire (or both tires of a dual assembly) by taking out the valve core(s).
- **Use a non-flammable vegetable or soap-based rubber lubricant** on the beads and rim surfaces to make tire demounting and mounting easier.
- **Use proper tools to demount or mount tires and rims** (refer to "Typical Tire Service Tools"). **NEVER** use a steel hammer to seat rim components—use only rubber, plastic or brass-tipped mallets. Striking a rim/wheel assembly with a hard-faced hammer can damage the components and endanger the installer. Use a steel duck bill hammer only as a wedge to unseat the beads of tube-type tires. **NEVER** strike the tire/wheel assembly with a steel duck bill hammer to unseat the beads and do not strike the head of the duck bill hammer with another hard-faced hammer – use a rubber mallet or plastic dead blow hammer. Slide impact tools and hydraulic bead unseating tools can also be used to unseat beads on tube-type tires.
- **NEVER** reinflate any tire that has been operated in a run-flat or underinflated condition (i.e., operated at 80% or less of recommended operating pressure). Demount, inspect and match all tire and rim components before reinflating in a restraining device with the valve core removed.

### **WARNING**

**IF YOU DO NOT KNOW HOW TO USE TIRE SERVICING TOOLS — STOP!  
TIRE SERVICING MUST ONLY BE PERFORMED BY TRAINED PERSONNEL.  
FAILURE TO FOLLOW PROPER PROCEDURES CAN RESULT IN SERIOUS INJURY OR DEATH.**

- **ALWAYS** wear adequate protective eyewear (or face shield), protective footwear, and ear protection while servicing tires to avoid injury.
- **NEVER** use a tire tool for anything except demounting and mounting tires.
- **NEVER** use an extension or "cheater" bar with tire irons.
- **ALWAYS** use soft-faced hammers when driving tire irons or assembling components.
- **NEVER** use a hammer with a loose or cracked handle.
- **NEVER** use a bent, cracked, chipped, dented or mushroomed tool. Keep tools clean and inspect them frequently.
- **NEVER** alter or apply heat to any tire service tool.



# 2

## DEFLATING AND DEMOUNTING TIRE FROM RIM/WHEEL ASSEMBLY

- **ALWAYS completely deflate** the tire assembly before attempting to demount. Remove the valve core and insert a wire down the valve stem to ensure complete deflation. **NEVER** demount a tire from a rim unless you are sure it is completely deflated.
- **Loosen beads** by using a slide impact bead unseating tool, duck bill hammer with a rubber mallet, or other bead unseating tools. Both beads must be loosened before demounting a tire.

### TUBE-TYPE; MULTI-PIECE

#### CURRENT PRODUCTION: TWO-PIECE SOLID RIM; SPLIT RING - LW, FL

**2A.** Make sure the top bead is unseated and below the side ring before attempting to remove it. Insert the tapered end of the lock ring tool into the notch and pry the side ring out of the rim gutter. Lift wheel from assembly.

**2B.** Continue to remove the side ring by progressively prying around the rim. Use small bites to prevent distorting the side ring.

**2C.** Place a tire stand on the rim. Turn the assembly over. Unseat the bottom bead. Remove the tire from the rim. Remove the tube and flap from the tire.



#### CURRENT PRODUCTION: THREE-PIECE SOLID RIM; SPLIT LOCK RING; SOLID FLANGE-M, CR, 5 DEGREE

**2D.** Make sure the top bead is unseated and the flange is below the lock ring before attempting to remove the lock ring. Insert the tapered end of the lock ring tool into the notch and pry the lock ring out of the rim gutter. Lift wheel from assembly.

**2E.** Insert the lock ring tool between the lock ring and the flange. Remove the lock ring by progressively prying around the rim. Use small bites to prevent distorting the lock ring. Remove solid flange.

**2F.** Place a tire stand on the rim. Turn the assembly over. Unseat the bottom bead. Remove the tire from the rim. Remove the tube and flap from the tire.

#### CURRENT PRODUCTION MULTI-PIECE



#### OBSOLETE\*: SPLIT RIM; SOLID RING-K

**2G.** Make sure the top bead is unseated and insert the tapered end of the lock ring tool into the notch in the rim near the split. Push the tool downward and toward the center of the rim. A block of wood may be placed under the left side of the rim split to help offset the rim base.

**2H.** Insert the tapered end of the lock ring tool into the second notch and push downward toward the center of the rim, prying the solid side ring from the rim. Remove the solid side ring.

**2I.** Place a tire stand on the rim. Turn the assembly over. Unseat the bottom bead. Remove the tire from the rim. Remove the tube and flap from the tire.



#### OBSOLETE MULTI-PIECE\*

#### OBSOLETE\*: SOLID RIM; SOLID RING-RH; 5 DEGREE

**2J.** Make sure the top bead is unseated and insert the tapered end of the lock ring tool into the notch in the solid side ring. This notch is located between the embossments on the solid side ring.

**2K.** Push the solid side ring downward at a point opposite the notch. Force the lock ring tool handle downward to pry the solid side ring from the rim. Continue prying around the rim until the solid side ring is free.

**2L.** Remove the solid side ring from the rim. Turn the assembly over and unseat the other bead. Remove the rim from the tire. \* NOTE: These rims are no longer in production and replacement parts are not available.



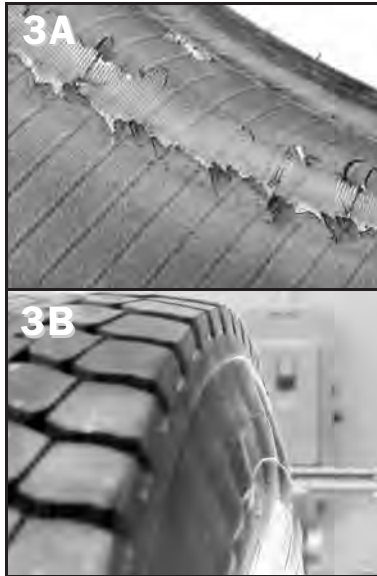
# 3

## INSPECTING TIRE AND RIM/WHEEL COMPONENTS

- **ALWAYS** conduct a visual and tactile inspection of the tire, rim/wheel and its components.
- **LOOK** and **FEEL** for any damage or evidence of being operated overloaded and/or in a run-flat condition (80% or less of its recommended operating inflation pressure).

Photo 3A is an example of innerliner damage created by an underinflated and overloaded condition.

**⚠ WARNING** Radial tires that have undulations or irregular sidewall distortions could possibly have permanent sidewall structural damage (steel cord fatigue). Ply cords weakened by underinflation and/or overloading may break one after another, until a rupture occurs in the upper sidewall with accompanying instantaneous air loss and explosive force. This can result in serious injury or death. Follow tire industry recommended inspection procedures for tires with these characteristics. Photo 3B is an example of sidewall undulations indicative of a potential “zipper rupture”.



- Remove rust, dirt, or foreign material from all tire and rim/wheel mating surfaces.
- **NEVER** use any multi-piece rim parts that are worn, bent, cracked, or pitted by corrosion. Clearly mark and remove all unserviceable parts from the service area.
- **DO NOT** rework, weld, heat or braze any rim parts or components for any reason.
- **ALWAYS** find the identification stamp on multi-piece rim components. Check Chart 3 *Multi-Piece Rim Matching* to see that the parts are properly matched. **NEVER** use a rim part unless you can positively identify it from the markings stamped by the manufacturer. If you cannot identify a multi-rim component, **DO NOT USE IT.** (See WARNINGS.)

### EXAMPLES OF UNSERVICEABLE PARTS

**BENT, RUSTED, CRACKED, OR WORN PARTS CANNOT BE SAFELY ASSEMBLED AND MUST BE CLEARLY MARKED AND REMOVED FROM THE SERVICE AREA. REPLACE THEM WITH PROPERLY MATCHED, SERVICEABLE PARTS.**



**⚠ WARNING**

**ANY INFLATED TIRE MOUNTED ON A WHEEL CONTAINS EXPLOSIVE ENERGY. THE USE OF DAMAGED, MISMATCHED OR IMPROPERLY ASSEMBLED TIRE AND WHEEL COMPONENTS CAN CAUSE THE ASSEMBLY TO SEPARATE WITH EXPLOSIVE FORCE. IF STRUCK BY AN EXPLODING TIRE, WHEEL COMPONENT, OR THE AIR BLAST, YOU OR SOMEONE ELSE MAY BE SERIOUSLY INJURED OR KILLED.**

# 4

## MOUNTING TIRE ON RIM/WHEEL ASSEMBLY

### TUBE-TYPE; MULTI-PIECE

**BEFORE MOUNTING A TUBE-TYPE TIRE ON THE RIM/WHEEL ASSEMBLY, BE SURE TO INSTALL AN INNER TUBE AS FOLLOWS:**

- Insert the tube into the tire and inflate with just enough air to round out the tube without creating wrinkles or creases.
- Insert the flap making sure the flap wings are not folded.
- Remove the valve core from the valve stem to prevent trapped air from interfering with the proper seating of the side or lock ring into the rim gutter.

**BEFORE INFLATING TIRE RIM/WHEEL ASSEMBLY, ALL RIM PARTS MUST BE PROPERLY MATCHED AND INSTALLED.**

#### TWO-PIECE

**INCORRECT**



**CORRECT**



#### THREE-PIECE

**INCORRECT**

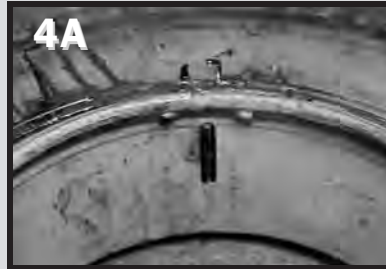


**CORRECT**



**CURRENT PRODUCTION: TWO-PIECE SOLID RIM; SPLIT RING - LW, FL**

**4A.** Lay the rim on the floor and align the valve stem with the slot in the rim. Lift the tire at the valve stem to work it onto the rim. For rims with bead humps, make sure the top bead is below the bead hump before attempting to install the side ring.



**4B.** Insert one end of the side ring into the rim gutter and use a rubber mallet or dead-blow hammer to progressively seat the remainder of the side ring in the rim gutter.



**CURRENT PRODUCTION: THREE-PIECE SOLID RIM; SPLIT LOCK RING; SOLID FLANGE-M, CR, 5 DEGREE**

**4C.** Lay the rim on the floor and align the valve stem with the slot in the rim. Lift the tire at the valve stem to work it onto the rim. For rims with bead humps, make sure the top bead is below the bead hump before attempting to install the side ring. Install the flange making sure it is below the rim gutter.



**4D.** Insert the end of the lock ring in the rim gutter and use a rubber mallet or dead-blow hammer to progressively seat the remainder of the lock ring in the rim gutter.



**4E.** Ensure the lock ring is completely seated in the rim gutter by using the rubber mallet or dead-blow hammer before attempting to inflate the tire.



# 5

## INFLATING TIRE ON RIM/WHEEL ASSEMBLY

### ⚠️ WARNING

TIRE AND RIM SERVICING CAN BE DANGEROUS AND MUST ONLY BE PERFORMED BY TRAINED PERSONNEL USING PROPER PROCEDURES AND TOOLS. FAILURE TO READ AND COMPLY WITH ALL OF THESE PROCEDURES MAY RESULT IN SERIOUS INJURY OR DEATH TO YOU AND OTHERS.

**⚠️ WARNING** If the parts are not seated properly, deflate the tire and correct the problem before proceeding. **NEVER** attempt to seat any part on a multi-piece tire/rim assembly by hammering, striking or prying while the tire contains inflation pressure. Striking the assembly in this manner is a DANGEROUS PRACTICE that may result in serious injury or death.

**⚠️ WARNING ALWAYS** inflate the tire rim/wheel assembly in a restraining device with the valve core removed. The air line assembly must consist of the following components: a clip-on air chuck, an in-line valve with a pressure gauge or presettable regulator, and sufficient hose length to keep the technician outside the trajectory during inflation. (See “Trajectory” WARNING below.) **DO NOT** rest or lean any part of your body against the restraining device during inflation. Failure to use a restraining device when inflating a tire rim/wheel assembly is not only a violation of OSHA regulation 1910.177, but also a DANGEROUS PRACTICE that may result in serious injury or death.

**⚠️ WARNING** During inflation, if ANY sidewall undulations or bulges appear or if ANY snapping, cracking or popping noises occur — **STOP! DO NOT** approach tire. Before removing from restraining device, completely deflate tire remotely. Remove clip-on air chuck. Mark tire as damaged for potential “zipper rupture”. Render tire unservicable, non-repairable and scrap.

**⚠️ WARNING NEVER** inflate beyond 40 psi to seat any tire beads. **NEVER** stand, lean, or reach over the tire rim/wheel assembly in the restraining device during inflation. Even if a tire is in a restraining device, inflating beyond 40 psi when trying to seat the beads is a DANGEROUS PRACTICE that may break a tire bead or the rim/wheel with explosive force and possibly result in serious injury or death.

### STEP-BY-STEP INFLATION PROCEDURES

1. Before inflating any tire rim/wheel assembly, be sure to read, understand and comply with ALL WARNINGS. For a tube-type tire, be certain that the side or lock ring is properly seated.
2. After mounting the tire on the rim, inflate to approximately 5 psi to seat the beads.
3. Place the assembly in an OSHA-compliant restraining device, such as a tire safety cage. Photo 5A is an example of a portable device. Manufacturers recommend that restraining devices be free-standing and located at least one foot away from any flat or solid surface.
4. Inflate the tire, with the valve core removed, using a clip-on air chuck with an in-line valve or pressure regulator and a sufficient length of hose. Inflate to 20 psi in restraining device. For tube-type tires, the tire can be deflated after reaching 20 psi and re-inflated to prevent inner tube wrinkles. **IMPORTANT!** Look for distortions, undulations, or other irregularities in the tire sidewall, such as in Photo 5B. Listen for any popping or snapping sounds. If ANY of these conditions are present — **STOP! DO NOT** approach tire. Before removing from restraining device, completely deflate tire remotely. Remove clip-on air chuck. Mark tire as damaged for potential “zipper rupture”. Render tire unservicable, non-repairable and scrap.

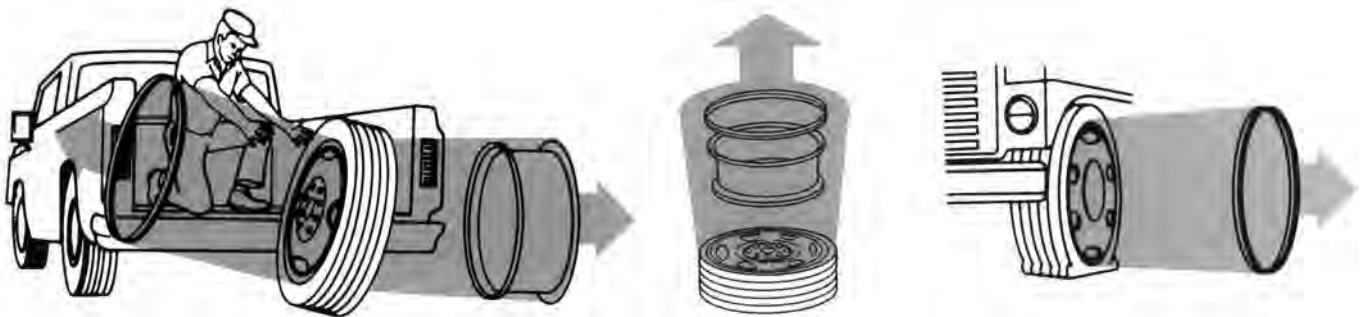


5. Visually inspect multi-piece tire rim/wheel assemblies throughout the inflation process for improper seating of the rings and/or beads. When inflating a tire, stay out of the trajectory. (See “Trajectory” Warning below.) **DO NOT** stand or lean any part of your body against, or reach over, the restraining device during inflation.
6. Continue to inflate until the beads are seated on the rim/wheel. Inspect both sides of the tire to be sure that the beads are evenly seated. **NEVER** inflate beyond 40 psi to seat any tire beads. If the beads are not seated at 40 psi — **STOP!** Completely deflate, remove from the restraining device, and determine the problem. Reposition the tire and/or inner tube on the rim, relubricate, and reinflate.
7. After the tire beads are seated, continue to inflate the tire to its recommended inflation pressure. **IMPORTANT!** Look for distortions, undulations, or other irregularities in the tire sidewall, such as in Photo 5B. Listen for any popping or snapping sounds. If ANY of these conditions are present — **STOP! DO NOT** approach tire. Before removing from restraining device, completely deflate tire remotely. Remove clip-on air chuck. Mark tire as damaged for potential “zipper rupture”. Render tire unservicable, non-repairable and scrap.
8. If none of these “zipper” conditions are present, remove clip-on air chuck, install the valve core, and adjust the inflation pressure to the recommended operating inflation pressure.
9. Before removing the tire rim/wheel assembly from the restraining device, always visually inspect for proper seating of the beads and all parts.
10. Conduct a final inspection. Check for air leaks. Install a suitable valve cap.

# **WARNING**

## **TRAJECTORY**

**THE AIR PRESSURE CONTAINED IN A TIRE IS DANGEROUS. THE SUDDEN RELEASE OF THIS PRESSURE BY A TIRE BLOW-OUT OR SIDE RING SEPARATION CAN CAUSE SERIOUS INJURY OR DEATH. STAY OUT OF THE TRAJECTORY AS INDICATED BY THE SHADED AREA DEPICTED IN THE GRAPHICS. WHEN INSTALLING THE TIRE RIM/WHEEL ASSEMBLY ON THE VEHICLE, IT WILL BE IMPOSSIBLE TO STAY OUT OF THE TRAJECTORY. HOWEVER, AT ALL OTHER TIMES YOU AND ALL OTHERS MUST STAY OUT OF THE TRAJECTORY.**



*NOTE: Under some circumstances, the trajectory may deviate from its expected path.*



**Occupational Safety  
and Health Administration**

U.S. Department of Labor

**www.osha.gov • (800) 321-OSHA (6742) • TTY (877) 889-5627**

# MULTI-PIECE RIM MATCHING CHART

**! WARNING**

TIRE AND RIM SERVICING CAN BE DANGEROUS AND MUST ONLY BE PERFORMED BY TRAINED PERSONNEL USING PROPER PROCEDURES AND TOOLS.

**! WARNING**

FAILURE TO READ AND COMPLY WITH ALL OF THESE PROCEDURES MAY RESULT IN SERIOUS INJURY OR DEATH TO YOU AND OTHERS.

## PLEASE NOTE:

THIS IS CHART 3 OF A 3-CHART SET. BE SURE TO ALSO READ, UNDERSTAND AND COMPLY WITH CHART 1 RE: DEMOUNTING AND MOUNTING PROCEDURES FOR TUBELESS TRUCK AND BUS TIRES AND CHART 2 RE: DEMOUNTING AND MOUNTING PROCEDURES FOR TUBE-TYPE TRUCK AND BUS TIRES

## DISCONTINUED PARTS

RIM REPLACEMENT PARTS THAT ARE OBSOLETE, DISCONTINUED OR NO LONGER IN PRODUCTION ARE SHADED IN RED.

If you are working on a rim/wheel assembly of discontinued parts that are cracked, bent, worn, pitted by corrosion, or unserviceable in any way, for whatever reason — **STOP!** You must discard all damaged components.

## EXAMPLES OF UNSERVICEABLE PARTS



## RIM PARTS NOT SHOWN IN CHART

**THIS CHART IS NOT ALL-INCLUSIVE.** Rim parts marked with **EXACTLY** the same size and type identification stamps may be used together even though they are not shown on this chart. Rim parts marked with different size and type identification stamps should **NEVER** be used together. Just because components come in together, does not mean they are matched. See WARNINGS.



# ! WARNING

**ALWAYS** comply with the procedures on this chart and in the wheel manufacturers' catalogs, instruction manuals or other industry and government instruction materials. Failure to do so may cause serious injury or death for you and others.

Any inflated tire mounted on a wheel contains explosive energy. The use of damaged, mismatched or improperly assembled tire and wheel components can cause the assembly to separate with explosive force. If struck by an exploding tire, wheel component, or the air blast, you or someone else may be seriously injured or killed.

Re-assembly and inflation of mismatched components on multi-piece tire and wheel assemblies can result in serious injury or death. Just because the components come in together does not mean they are matched. Check identification stamps for proper matching of all rim parts before assembling a multi-piece tire and wheel.

Mismatching tire and rim diameters is dangerous. A mismatched tire and rim assembly may separate and can result in serious injury or death. This warning applies to 16" and 16.5" tire and rim assemblies as well as other sized assemblies. **NEVER** assemble a tire and rim unless you have positively identified and correctly matched the tire and rim diameter.

Completely deflate any tire by removing the valve core before removing the tire/wheel assembly from the axle if there is known or suspected damage to the tire or wheel or if the tire has been operated at 80% or less of its recommended operating pressure. Demount, inspect and match all tire and rim parts before re-inflating in a restraining device.

**NEVER** use starter fluid, ether, gasoline, or other flammable materials and/or accelerants to lubricate the beads of a tire. This practice can cause the explosive separation of the tire/wheel during servicing or during highway use, which may result in serious injury or death.

## HOW TO USE THESE TABLES

### HOW TO MATCH RIM PARTS

1. Find the stamped identification on the rim base and ring(s). Refer to the pictures (see pictures bottom right) to help find the locations of the stamps. Identify the parts based on the stamps themselves—**DO NOT** identify the parts based only on the way they look.
2. If you cannot find the identification stamp—**STOP!** **NEVER** use a rim part that you cannot identify from the stamp.
3. Match the markings found on the rim base with those shown in the "Rim Base Identification Stamping" column in the tables below.
4. Continue reading the same line across the table to find the proper markings for the matching side ring (or lock ring and flange).
5. **NEVER** assemble mismatched rim parts (see WARNING above). If the identification stamps on the parts do not match—**STOP!** Select serviceable replacement parts from stock or obtain them from a rim supplier.
6. If you are working on a rim/wheel assembly of discontinued parts that are cracked, bent, worn, pitted by corrosion, or unserviceable in any way, for whatever reason—**STOP!** You must replace the entire discontinued assembly with one that is in current production. Examples of unserviceable parts are shown in the photos above.

### HOW TO READ THESE TABLES

#### Example A – Two-Piece Rim/Side Ring Assembly

1. The rim base and side ring to be assembled have identification stamps like the ones shown to the right.

2. Find 20 x 7.5 rim size in the "Rim Size" column in the tables below. Locate 20 x 7.5 FL in the "Rim Base Identification Stamping" column.

3. Continue reading the same line across the table. Find the matching side ring markings in the "Side Ring Identification Stamping" column.

4. One of the proper markings is: 20 x 7.5 FL. This matches the stamp of the side ring shown in the photo. These parts are matched and will make a proper assembly.



#### Example B – Three-Piece Rim/Side Ring Assembly

1. Follow Steps 1 and 2 in Example A – Two-Piece Assembly.

2. Read across the table in the same row to find the proper match in the "Lock Ring Identification Stamping" and "Flange Identification Stamping" columns.

## MULTI-PIECE RIM MATCHING CHART CURRENT PRODUCTION

### 2-PIECE

Rim Size	Rim Base Identification Stamping	Side Ring Identification Stamping
15 X 6.5	15 X 6.5 LW	R15 X 6.5-7.0 LB-LW
15 X 7.5	15 X 7.5 LW	R15 X 7.5-8.0 LB-LW
20 X 6.5	20 X 6.5 LW	R20 X 6.5-7.0 LB-LW
20 X 7.5	20 X 7.5 FL	R20 X 7.5 FL
	20 X 7.5 LW	R20 X 7.5-8.0-9.0 LB-LW
20 X 8.0	20 X 8.0 LW	R20 X 7.5-8.0-9.0 LB-LW
20 X 9.0	20 X 9.0 LW	R20 X 7.5-8.0-9.0 LB-LW
24 X 8.0	24 X 8.0 LW	R24 X 7.5-8.0-9.0 LB-LW
24 X 9.0	24 X 9.0 LW	R24 X 7.5-8.0-9.0 LB-LW

### 3-PIECE

Rim Size	Rim Base Identification Stamping	Lock Ring Identification Stamping	Flange Identification Stamping
20 X 7.5	20 X 7.5 M	LR 20 X 7.5-8.5-10.0 M	F 20 X 7.5-8.5 M
	20 X 7.5-5°	20 X 7.0-7.5-8.0-5°	20 X 7.5-8.05°-7.5 FL
20 X 8.0	20 X 8.0-5°	20 X 7.0-7.5-8.0-5°	20 X 7.5-8.05°-7.5 FL
20 X 8.5	20 X 8.5 M	LR 20 X 7.5-8.5-10.0 M	F 20 X 7.5-8.5 M
20 X 10.0	20 X 10.0 M	LR 20 X 7.5-8.5-10.0 M	F 20 X 10.0 M
22 X 8.0	22 X 8.0-5°	22 X 7.0-7.5-8.0-5°	22 X 8.0-5°
24 X 7.5	24 X 7.5 M	LR 24 X 7.5-8.5-10.0 M	F 24 X 7.5-8.5 M
24 X 8.0	24 X 8.0-5°	24 X 7.0-7.5-8.0-5°	24 X 8.0-5°
24 X 8.5	24 X 8.5M	LR 24 X 7.5-8.5-10.0 M	F 24 X 7.5-8.5 M
	24 X 8.5-5°	24 X 8.5-5°	24 X 8.5-5°
24 X 10.0	24 X 10.0 M	LR 24 X 7.5-8.5-10.0 M	F 24 X 10.0 M

## MULTI-PIECE RIM MATCHING CHART OUT-OF-PRODUCTION (OBSOLETE)

### 2-PIECE

Rim Size	Rim Base Identification Stamping	Side Ring Identification Stamping
15 X 5.5	15 X 5.5 LTS; B5515 TS	R15 X 5.5 LTS; R5515 TS
	15 X 5.5 LW; B5515 LW	R15 X 5.5-6.0 LB-LW; R5515 LW; R5015 L
	15 X 5.50 F RHP	15 X 5.00 F RHP; 15 X 4.50E-5.50 F RIP
15 X 6.0	15 X 6.0 LTS; B6015 TS	R15 X 6.0 LTS; R6015 TS
	15 X 6.0 LW; B6015 LW	R15 X 5.5-6.0 LB-LW; R5515 LW
15 X 6.5	B6515 LW	R15 X 6.5-7.0 LB-LWⓈ; R6515 LW; R6015 L
15 X 7.0	15 X 7.0 LW; B7015 LW	R15 X 6.5-7.0 LB-LWⓈ; R6515 LW
	1715 15-7.0	1715 RC15-7.0
15 X 7.5	1115 15-7.5	1115 RC15-7.5
	B7515 LW	R15 X 7.5-8.0 LB-LWⓈ; R8015 LW
	B7515 LB	R8015 LW
16 X 5.5	16 X 5.5 LTS; 16 X 5.50 F-LTS; B5516 TS	R16 X 5.5 LTS; R5516 TS; 16 X 5.50 F-LTS
	16 X 5.50 F RHP	16 X 5.50 F RHP; 16 X 4.50E-5.50 F RIP
	16 X 5.50 F-DUOⓈ	R5516 LTS Ⓢ; 16X5.50F LTSⓈ; DUO 16X5.5 F
16 X 6.0	16 X 6.0 LTS; B6016 TS	R16 X 6.0 LTS; R6016 TS
	16 X 6.00 G RHP	16 X 6.00 G RHP; 16 X 6.00 G RIP
16 X 6.5	16 X 6.5 LTS; B6516 TS	R16 X 6.5 LTS; R6516 TS

20 X 5.0	B5020 LW B5020 KW	R5020 LW R5020 KW
20 X 5.5	B5520 LW 20 X 5.50 F RHP B5520 KW	20 X 5.5-6.0DT-LB-LW®; R5520 LW 20 X 5.50 RHP; 20 X 5.50F RIP R5520 KW
20 X 6.0	20 X 6.0 FL 20 X 6.0 LB; B6020 LB; 20 X 6.0 DT-LB® 20 X 6.0 LW; B6020 LW 20 X 6.0 RH5°; 20 X 6.0 -RH5° 20 X 6.0 XL B6020 KW BW-5 20 X 6.0	20 X 6.0 FL R20 X 5.5-6.0 LB-LW; R5520 LW; 20 X 5.5-6.0DT-LB-LW® R20 X 5.5-6.0 LB-LW; R5520 LW; 20 X 5.5-6.0DT-LB-LW® 20 X 6.0 RH5° 20 X 6.0 XL; 20 X 6.0-6.5 XL R5520 KW BW-5 20 X 6.0
20 X 6.5	20 X 6.5 CR; B6520 CR 20 X 6.5 LB; B6520 LB; 20 X 6.5 DT-LB® B6520 LW 20 X 6.5 RH5°; 20 X 6.5 -RH5° 20 X 6.5 XL B6520 KW BW-5 20 X 6.5	20 X 6.5-7.0 CR; R6520 -CR; R20 X 6.5-7.0 CR R20 X 6.5-7.0 LB-LW®; R6520 LW; 20 X 6.5-7.0 DT-LB-LW® R20 X 6.5-7.0 LB-LW®; R6520 LW; 20 X 6.5-7.0DT-LB-LW® 20 X 6.5 RH5° 20 X 6.5 XL; 20 X 6.0-6.5 XL R6020 K; R6520 K BW-5 20 X 6.5-7.0 T
20 X 7.0	20 X 7.0 CR; B7020 CR 1720 20-7.0; K-H 20 X 7.0 20 X 7.0 LB; B7020 LB; 20 X 7.0 DT-LB® 20 X 7.0 LW; B7020 LW B7020 KB B7020 KW B7020 KWX 20 X 7.0 BW5°	20 X 6.5-7.0 CR; R20 X 6.5-7.0 CR; R6520 CR 1720 RC20-7.0 R20 X 6.5-7.0 LB-LW® R6520 LW; 20 X 6.5-7.0 DT-LB-LW® R20 X 6.5-7.0 LB-LW® R6520 LW; 20 X 6.5-7.0 DT-LB-LW® R6520 KW R6520 KW R6520 KW BW-5 20 X 6.5-7.0 T
20 X 7.5	B7520 FL 1020 20-7.5; T/M 20-7.5 8-A3-190 1120 20-7.5; D-13520 20-7.5; A-AA 2951 20-7.5; K-H 20 X 7.5 20 X 7.5 LA; 20 X 7.5 MS; B7520 LA 20 X 7.5 LB; 20 X 7.5DT-LB®; B7520LB; G20750B® 20 X 7.50 LW; B7520 LW; G20750B® B7520 KB B7520 KW B7520 KWX BW-5 20 X 7.5	20 X 7.5 FL; R20 X 7.5 FL®; R7520 FL 1020 RC 20-7.5; T/M 2.0-7.5 8-A3-190 1120 RC 20-7.5; D 2.0-7.5 D 13520 SR; F20-7.5 A-AA 2951-1 R20 X 7.5 LA; 20 X 7.5 MS; R7520 LA R20 X 7.5-8.0-9.0 LB-LW®; 20 X 7.5-8.0 DT-LB-LW®; R8020 LW R20 X 7.5-8.0-9.0 LB-LW®; 20 X 7.5-8.0 DT-LB-LW®; R8020 LW R8020 KW R8020 KW R8020 KW BW-5 20 X 7.5
20 X 8.0	20 X 8.00 LW; B8020 LW; G20800B® B8020 KW	R20 X 7.5-8.0-9.0 LB-LW®; 20 X 7.5-8.0 DT-LB-LW®; R8020 LW R7520 K
20 X 9.0	B9020 M	R20 X 7.5-8.0-9.0 LB-LW®; R8020 LW; R7520 L
20 X 10.0	20 X 10.0 LA; B1020 LA	R20 X 10.0 LA; R1020 LA
22 X 7.5	1022 22-7.5; T/M 22-7.5 8-A3-191 1122 22-7.5; D-13522 22-7.5; A-AA2952 22-7.5 22 X 7.5 FL; B7522 FL 22 X 7.5 LB; 22 X 7.5DT-LB®; B7522 LB; G22750B® 22 X 7.5 LW; 22 X 7.50 LW; B7522 LW; G22750B® B7522 KB B7522 KW B7522 KWX BW-5 22 X 7.5	1022 RC22-7.5; T/M 22-7.5 8-A3-191 1122 RC22-7.5; D 22-7.5D 13522-SR; F 22-7.5 A-AA2952-1 22 X 7.5 FL; R22 X 7.5 FL; R7522 FL R22 X 7.5-8.0-9.0 LB-LW; 22 X 7.5-8.0 DT-LB-LW®; R8022 LW R22 X 7.5-8.0-9.0 LB-LW; 22 X 7.5-8.0 DT-LB-LW®; R8022 LW R8022 KW R8022 KW R8022 KW BW-5 22 X 7.5
22 X 8.0	22 X 8.0 LW; 22 X 8.00 LW; B8022 LW; G22800B® B8022 KW	R22 X 7.5-8.0-9.0 LB-LW; 22 X 7.5-8.0 DT-LB-LW®; R8022 LW R7522 KW
24 X 8.0	B8024 LW B8024 KW	R24 X 7.5-8.0-9.0 LB-LW®; R8024 LW; R7524 L R7524 K
24 X 9.0	B9024 M	R24 X 7.5-8.0-9.0 LB-LW®; R8024 LW; R7524 L
24 X 10.0	24 X 10.0 LA; B1024 LA	R24 X 10.0 LA; R1024 LA

# MULTI-PIECE RIM MATCHING CHART OUT-OF-PRODUCTION (OBSOLETE)

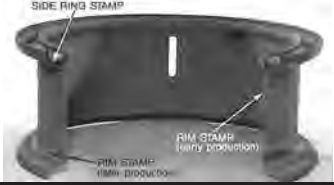


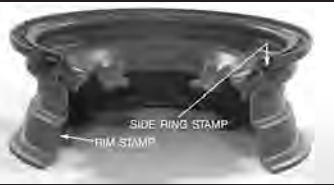

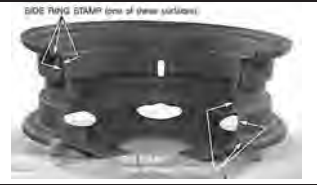

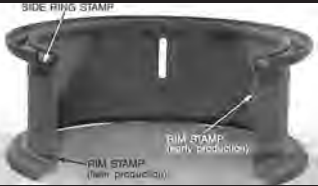

## 3-PIECE

Rim Size	Rim Base Identification Stamping	Lock Ring Identification Stamping	Flange Identification Stamping
15 X 7.0	15 X 7.0-5°	15 X 7.0-7.5-8.0-5°	15 X 7.0-5°
15 X 7.5	15 X 7.5-5°	15 X 7.0-7.5-8.0-5°	15 X 7.5-5°
20 X 5.0	20 X 5.0	20 DIA	20 X 5
20 X 6.0	20 X 6.0-5°	20 X 6.0-5°	20 X 6.0-5°-FL
	20 X 6.0 FL	20 X 6.0 FL	20 X 6.0-5°-FL
	20 X 6.0	20 DIA	20 X 6
	BW-5 20 X 6.0	BW-5 20 X 6.5-7.0 T	BW-5 20 X 6.0
20 X 6.5	20 X 6.5-5°	20 X 6.5-5°	20 X 6.5-5°-CR; F6520 CR
	20 X 6.5 CR; B6520 CR	20 X 6.5-7.0 CR; LR6520 CR; LR20 X 6.5-7.0 CR	20 X 6.5-5°-FL-CR; F6520 CR; F20X6.5 CR
	20 X 6.5	20 DIA	20 X 6.5
20 X 7.0	20 X 7.0 CR; B7020 CR	20 X 6.5-7.0 CR; LR6520 CR; LR20 X 6.5-7.0 CR	20 X 7.0-5°-FL-CR; F7020 CR; F20 X 7.0 CR; 20 X 7.0-5°-FL-CR-8.00 RTH
	20 X 7.0-5°	20 X 7.0-7.5-8.0-5°	20 X 7.0-5°-FL-CR-8.00 RTH; F7020 CR; 20 X 7.0-5°-FL-CR
	20 X 7.0 BW5°	BW-5 20 X 6.5-7.0 T	BW-5 20 X 6.5-7.0 T
20 X 7.5	B7520 FL	20 X 7.5 FL; LR20 X 7.5 FL; LR7520 FL	20 X 7.5-5°-FL; 20 X 7.5-8.05°-7.5 FL; F20 X 7.5 FL; F7520 FL
	20 X 7.5 MⓄ	LR20 X 7.5-8.5-10.0 MⓄ; LR20 M	F20 X 7.5-8.5 MⓄ; F7520 M
	20 X 7.50-5°; F20750 BⓄ	20 X 7.0-7.5-8.0-5°Ⓞ	20 X 7.5-5°-FL; 20 X 7.5-8.05°-7.5 FLⓄ; F7520 FL
20 X 8.0	20 X 8.00-5°; F20800 BⓄ	20 X 7.0-7.5-8.0-5°	20 X 8.0-5°; 20 X 7.5-8.05°-7.5 FLⓄ
	BW-5 20 X 8.0	BW-5 20 X 7.5-8.0V-8.5V	BW-5 20 X 8.0V-8.5V
20 X 8.5	20 X 8.5-5°	20 X 8.5-5°	20 X 8.5-5°
	20 X 8.5 MⓄ	LR20 X 7.5-8.5-10.0 MⓄ; LR20 M	F20 X 7.5-8.5 MⓄ; F7520 M
20 X 10.0	B1020 M	LR20 X 7.5-8.5-10.0 MⓄ; LR20 M	F20 X 10.0 MⓄ; F1020 M
22 X 7.5	22 X 7.5-5°; 22 X 7.50-5°; F22750 BⓄ	22 X 7.0-7.5-8.0-5°	22 X 7.5-5°-FL; 22 X 7.5-8.05°-FL; F22 X 7.5 FL; F7522 FL; 22 X 7.5-8.05°-7.5 FL
	22 X 7.5 FL; B7522 FL	22 X 7.5FL; LR22 X 7.5 FL; LR7522 FL	22 X 7.5-5°-FL; 22 X 7.5-8.05°-FL; F22 X 7.5 FL; F7522 FL; 22 X 7.5-8.05°-7.5 FL
	22 X 7.5 M	LR22 M; LR22 X 7.5-8.5-10 M	F7522 M
	BW-5 22 X 7.5	BW-5 22 X 7.5-8.0V-8.5V	B-5° 22 X 7.5
	22 X 8.0	22 X 8.00-5°; F22800 BⓄ	22 X 7.0-7.5-8.0-5°Ⓞ
	BW-5 22 X 8.0	BW-5 22 X 7.5-8.0V-8.5V	BW5 22 X 8.0V-8.5V
24 X 7.5	24 X 7.5 MⓄ	LR24 X 7.5-8.5-10.0 MⓄ; LR24 M	F24 X 7.5-8.5 MⓄ; F7524 M
	24 X 7.5-5°	24 X 7.0-7.5-8.0-5°Ⓞ	24 X 7.5-5°; 24 X 7.5-8.0-5°; 24 X 8.0-5°Ⓞ
24 X 8.0	24 X 8.0-5°Ⓞ	24 X 7.0-7.5-8.0-5°Ⓞ	24 X 7.5-8.0-5°; 24 X 8.0-5°Ⓞ
24 X 8.5	24 X 8.5 M	LR24 X 7.5-8.5-10.0 MⓄ; LR24 M	F24 X 7.5-8.5 MⓄ; F7524 M
24 X 10.0	B1024 M	LR24 X 7.5-8.5-10.0 MⓄ; LR24 M	F24 X 10.0 MⓄ; F1024 M

### NOTES

- ① Wheel numbers 86130, 86140, 86680, 86940, 87160, 87430, 87440, 87500, 87510, 87560, 87740, 88540, 88630 associated with the 16 x 5.50 F Duo rim use LTS rings. All other DUO rims use "C" section side rings (DUO 16 x 5.50 F).
- ② Some aluminum wheel stampings are followed by a character (X-T-N-B) which indicates a finished surface condition. This does not affect the interchangeability of the parts as shown on this table.
- ③ "DT", "LB", "LW" and "DT-LB-LW" are interchangeable components.
- ④ This product is still being manufactured for use with other components.

**EXAMPLES OF TYPICAL RIM CONTOURS AND IDENTIFICATION STAMP LOCATIONS**

2-PIECE CURRENT PRODUCTION: CR, DT, FL, LA, LB, LW, MS	2-PIECE CURRENT PRODUCTION: REDCO	3-PIECE CURRENT PRODUCTION: 5°, CR, FL, M
		
<b>DISCONTINUED: DUO, LTS, RHP</b>	<b>DISCONTINUED: AR</b>	<b>DISCONTINUED: RH5°</b>
		
<b>DISCONTINUED: XL, RIP</b>	<b>DISCONTINUED: K, K28, KB, KW, KWX</b>	<b>DISCONTINUED: GREAT DANE, K-H, DORSEY, TRAILMOBILE, STRICK CORP, FRUEHAUF</b>
		

**You have a right to a safe workplace.**  
 If you have questions about workplace safety and health, call OSHA at 1-800-321-OSHA (6742).  
**It's confidential.**  
 We can help!



**Occupational Safety and Health Administration**  
 U.S. Department of Labor  
 www.osha.gov • (800) 321-OSHA (6742) • TTY (877) 889-5627



U.S. Department of Labor

**OSHA**<sup>®</sup> **Occupational  
Safety and Health  
Administration**

**[www.osha.gov](http://www.osha.gov) • (800) 321-OSHA (6742) • TTY (877) 889-5627**