

Preliminary (Stage 1) Alternatives Analysis Report Motor Vehicle Tires Containing N-(1,3- dimethylbutyl)-N'-phenyl-p-phenylenediamine (6PPD)

Prepared for
U.S. Tire Manufacturers Association (USTMA)
1400 K St NW #900
Washington, DC 20005

July 17, 2024



www.gradientcorp.com
600 Stewart Street, Suite 1900
Seattle, WA 98101
206-267-2920

Table of Contents

	<u>Page</u>
Executive Summary.....	ES-1
1 Preparer Information	1
2 Consortium Members and Supply Chain Information	2
3 Priority Product Information	3
3.1 Priority Product Made by Consortium Members Participating in This Alternatives Analysis Report.....	3
3.1.1 Overview of Motor Vehicle Tire Composition and Manufacturing	3
3.1.1.1 Tire materials and tire compounding.....	4
3.1.1.2 Tire manufacturing processes.....	5
3.1.2 Different Types of Tires.....	6
3.1.2.1 Passenger car and light truck tires.....	6
3.1.2.2 Truck and bus radial tires.....	7
3.1.2.3 Motorcycle tires.....	8
3.2 Chemical of Concern for the Priority Product.....	8
3.3 Function of the Chemical of Concern in the Priority Product	9
3.4 Key Performance Requirements for the Priority Product	11
3.4.1 Testing of Rubber Compounds Prior to Actual Tire Development	11
3.4.2 Regulatory Requirements for Motor Vehicle Tires	12
3.4.2.1 Passenger and light truck tires.....	13
3.4.2.2 Uniform tire quality grading for passenger car tires	14
3.4.2.3 Regulatory Testing Requirements for Truck and Bus Radial Tires and Motorcycle Tires	14
3.4.3 Compliance with and Enforcement of NHTSA Regulations	14
3.4.4 Additional Manufacturer Test Criteria for Highway Tires	15
3.4.4.1 Indoor (drum tests) for passenger and light truck tires	15
3.4.4.2 Outdoor (vehicle) tests for passenger and light truck tires.....	16
3.4.4.3 Optional technical tests for passenger and light truck tires.....	17
3.4.4.4 Additional Manufacturer Test Criteria for Truck and Bus Radial Tires	17
3.4.5 SmartWay Certification for Truck and Bus Radial Tires.....	18
3.4.6 Summary of Performance Testing Requirements	18
3.4.7 Other Regulatory Requirements for the Priority Product	18
3.5 Necessity of the Function of the Chemical of Concern in the Priority Product	19

4	Scoping, Identification of Possible Alternatives and Relevant Factors	20
4.1	Purpose and Approach for this Stage 1 AA	20
4.2	Alternatives Under the SCP Regulation	20
4.3	Inclusion of Performance as a Consideration in the Stage 1 AA	20
4.4	Scoping: Alternatives Outside the Scope of This AA Report	21
4.4.1	Non-Pneumatic Tires	21
4.4.2	Electrostatic Particle Collectors	22
4.4.3	Modified EPDM or halobutyl rubber to reduce 6PPD concentrations in sidewall.....	22
4.4.4	Waxes and Coatings.....	24
4.5	Possible Alternatives to 6PPD in Motor Vehicle Tires.....	24
4.5.1	Approach for Identification of Alternatives	24
4.5.2	Possible Alternatives Identified	26
4.5.2.1	Possible Alternative PPDs	26
4.5.2.2	Possible non-PPD chemical alternatives	27
4.6	Relevant Factors	28
4.6.1	Information on Sales of the Priority Product in California	28
4.6.2	Relevant Exposure Pathways	29
4.6.3	Conceptual Model for Product Life Cycle.....	29
4.7	Life Cycle Segments	30
4.7.1	Raw Materials Extraction.....	30
4.7.2	Resource Inputs and Other Resource Consumption	31
4.7.3	Intermediate Materials Processes	31
4.7.4	Manufacture	32
4.7.5	Packaging.....	32
4.7.6	Transportation/Distribution.....	33
4.7.7	Use.....	33
4.7.8	Operation and Maintenance.....	34
4.7.9	Waste Generation and Management	34
4.7.10	Reuse and Recycling	34
4.7.11	End-of-life Disposal.....	35
5	Comparison of Alternatives.....	36
5.1	Hazard	36
5.1.1	Hazard Evaluation Approach.....	36
5.1.1.1	Hazard of Constituents <i>versus</i> Risk of Final Products	36
5.1.1.2	Group A Endpoints.....	37
5.1.1.3	Group B Endpoints.....	37
5.1.1.4	Salmonid Acute Toxicity.....	38
5.1.1.5	USGS studies of alternatives involving cell lines	39
5.1.1.6	Transformation Products.....	40
5.1.2	Hazard Scoring Approach.....	41
5.1.3	Hazard Scoring Results.....	43
5.1.3.1	Hazards of 6PPD and Possible Alternatives.....	43

5.1.3.2	Group B Human Health Hazard Endpoints.....	45
5.1.3.3	Salmonid Acute Toxicity – Parent Chemicals	45
5.1.3.4	Salmonid Acute Toxicity – Quinone Products	46
5.1.3.5	USGS Predecisional Summary.....	46
5.1.3.6	Hazards of environmental degradation products	47
5.2	Performance.....	47
5.2.1	Performance Data from Studies Pre-2020	48
5.2.2	Performance Testing at Flexsys of Possible Alternatives also Tested by USGS	55
5.2.3	Recent Performance Data at Other Laboratories (Post-2020)	55
5.2.4	Future Testing Required	59
5.3	Relative Exposure Potential.....	64
5.3.1	Relative Exposure Potential of 6PPD and Possible Alternatives.....	64
5.3.2	Relative Exposure Potential of Potential Breakdown Products.....	66
6	Conclusions of Stage 1 AA	67
6.1	Selecting Possible Alternatives to the Priority Product.....	67
6.2	Possible Alternatives to Priority Product to Consider in Stage 2	68
6.3	Alternatives to be Eliminated from Further Consideration.....	69
6.4	Decision Concerning Abridged AA or Stage 2 AA	71
7	Work Plan For Stage 2 AA.....	72
7.1	Tasks for Stage 2 AA and Final AA Report.....	72
7.2	Proposed Stage 2 AA Completion Schedule.....	73
8	Uncertainty Analysis.....	75
9	References	78
Appendix A	Glossary of Tire Related Terms	
Appendix B	List of Products Covered by This AA	
Appendix C	SDS for Santoflex™ 6PPD Pastilles	
Appendix D	Survey Concerning 6PPD Alternatives Sent to Consortium Members	
Appendix E	Derivation of Estimated Tire Shipments into the State of California	
Appendix F	List of All Candidate Alternatives Identified and Reviewed by the Consortium	

List of Tables

Table 3.1	U.S. Tire Industry Shipments Summary
Table 3.2	Potential Laboratory Screening Tests for Requirements by Rubber Compound
Table 4.1	Possible PPD Derived Alternatives Meriting Further Study in Stage 1 AA
Table 4.2	Possible Non-PPD Alternatives Meriting Further Study in Stage 1 AA
Table 4.3	Estimated Annual Shipments of the Priority Product in California
Table 4.4	Consideration of Potentially Relevant Factors Identified in SCP Regulation
Table 4.5	Life Cycle Elements Considered in Evaluating Potential Exposures
Table 4.6	Production Process Chemistry for 6PPD and Possible Alternatives
Table 5.1	Chemical-Specific Human Health Hazards (Group A Endpoints)
Table 5.2	Chemical-Specific Human Health Hazards (Group B Endpoints)
Table 5.3	Chemical-Specific Environmental and Physical Hazards
Table 5.4	Acute Toxicity Data in Salmonids Reported in Existing Scientific Literature
Table 5.5	Scoring Matrix – Human Health Endpoints
Table 5.6	Scoring Matrix – Ecological Health Endpoints
Table 5.7	Scoring Matrix – Physical/Chemical Hazards
Table 5.8	Chemical-Specific Hazard Scoring Summary
Table 5.9	Physical-Chemical Properties
Table 5.10	Physical-Chemical Properties and Hazards of Transformation Products of 6PPD and Possible Alternative Chemicals
Table 5.11	Performance Data on Possible Alternatives From Sources Prior to 2020
Table 5.12	Performance Testing at Flexsys of Possible Alternative Also Tested by USGS
Table 5.13	Performance Data for Possible Alternative from 2020 to Jan 2024
Table 5.14	Non-Exhaustive List of Performance Testing for Candidate Antidegradant Chemicals or Materials in Tires
Table 5.15	Stage 1 Alternatives Analysis Report Conclusions Based on Available Data
Table 7.1	Proposed Stage 2 AA Completion Schedule

List of Figures

- Figure 3.1 Typical Construction Features of a Pneumatic Radial Passenger Car Tire
- Figure 3.2 Typical Construction Features of a Pneumatic Radial Medium Commercial Truck/Bus Tire
- Figure 3.3 Chemical Structure of 6PPD
- Figure 3.4 Chemical Structure of 6PPD Quinone
- Figure 3.5 Dynamic Antiozonant Effect of 6PPD, 0.5 ppm Ozone Concentration, 40°C, 48 hours
- Figure 4.1 Examples of Non-Pneumatic Tire Products
- Figure 4.2 Conceptual Exposure Model: Motor Vehicle Tires Containing 6PPD
- Figure 4.3 Conceptual Exposure Model: Motor Vehicle Tires Containing Possible Alternatives to 6PPD

Abbreviations

6PPD	N-(1,3-Dimethylbutyl)-N'-phenyl-p-phenylenediamine
6PPDQ	N-(1,3-Dimethylbutyl)-N'-phenyl-p-phenylenediamine quinone
6QDI	N-1,3-Dimethylbutyl-N'-phenyl quinone diimine
7PPD	N-(1,4-Dimethylpentyl)-N'-phenyl-p-phenylenediamine
77PD	N,N'-Bis(1,4-dimethylpentyl)-p-phenylenediamine
AA	Alternatives Analysis
ASTM	American Society for Testing and Materials
BCF	Bioconcentration Factor
CAFE	Corporate Average Fuel Economy
CalDTSC	California Department of Toxic Substances Control
CARB	California Air Resources Board
CAS	Chemical Abstracts Service Number
CASRN	Chemical Abstracts Service Registry Number
CCPD	N,N'-Dicyclohexyl-p-phenylenediamine
CCR	California Code of Regulations
CPPD	N-Cyclohexyl-N'-phenyl-p-phenylenediamine
CPSC	U.S. Consumer Product Safety Commission
CSI	Chemical Scoring Index
DAPD	Diaryl-p-phenylene diamine
DNA	Deoxyribonucleic Acid
DNPDA	N,N'-Di-2-naphthyl-p-phenylenediamine
DOPD	4,4'-Dioctyldiphenylamine
DPPD	N,N'-Diphenyl-p-phenylenediamine
DTPD	N,N'-Ditolyl-p-phenylenediamine
DTSC	Department of Toxic Substances Control
ECHA	European Chemicals Agency
EPDM	Ethylene Propylene Diene Monomer
EU	European Union
FHSA	Federal Hazardous Substances Act
FMVSS	Federal Motor Vehicle Safety Standards
GHS	Globally Harmonized System of Classification and Labelling of Chemicals
GPC	Global Product Classification
GRAS	Generally Recognized as Safe
GWP	Global Warming Potential
HCl	Hydrochloric Acid
Hg	Mercury
HSDB	National Library of Medicine's Hazardous Substance Data Base
IMAP	Australia Inventory Multi-Tiered Assessment and Prioritisation
IPCC	Intergovernmental Panel on Climate Change
IPPD	N-Isopropyl-N'-phenyl-p-phenylenediamine
K _{oc}	Log Organic Carbon Partition Coefficient
K _{ow}	Log Octanol-Water Partition Coefficient
LC ₅₀	Median Lethal Concentration

LCA	Life Cycle Assessment
LOLI	Underwriters Laboratories, Inc.'s List of Lists
MCDA	Multi-Criteria Decision Analysis
NBC	Nickel Dibutyldithiocarbamate
NESHAP	National Emission Standards for Hazardous Air Pollutants
NHTSA	National Highway Traffic Safety Administration
ODI	Office of Defects Investigation
ODP	Ozone-Depleting Potential
OE	Original Equipment
OECD	Organisation for Economic Co-operation and Development
OEM	Original Equipment Manufacturer
OPERA	Open (Quantitative) Structure-Activity/Property Relationship App
OVSC	Office of Vehicle Safety Compliance
PBT	Persistent, Bioaccumulative, and Toxic
PPDs	Paraphenylene Diamines
PPE	Personal Protective Equipment
pphm	Parts Per Hundred Million
QSAR	Quantitative Structure-Activity Relationship
RE	Responsible Entity
REACH	Registration, Evaluation, Authorisation, and Restriction of Chemicals
RKIS	Rotary Kiln Incinerator Simulator
RRC	Rolling Resistance Coefficient
SBR	Styrene Butadiene Rubber
SCP	Safer Consumer Products
SDS	Safety Data Sheet
SMART	Shape Memory Alloy Radial Technology
SMILES	Simplified Molecular Input Line Entry System
TAC	California's Toxic Air Contaminant List
TAPDT	2,4,6-tris-(N-1,4-dimethylpentyl-para-phenylenediamino)-1,3,5 triazine
TDF	Tire-Derived Fuel
TIN	Tire Identification Number
TMQ	Poly(1,2-dihydro-2,2,4-trimethyl-quinoline)
TREAD Act	Transportation Recall Enhancement, Accountability, and Documentation Act
TRWP	Tire and Road Wear Particles
TSCA	Toxic Substances Control Act
UVCBs	Unknown or Variable Compositions, Complex Reaction Products, and Biological Materials
UL	Underwriters Laboratories, Inc.
UN	United Nations
URMS	Urban Runoff Mortality Syndrome
US DOT	United States Department of Transportation
USGS	United States Geological Survey
US EPA	United States Environmental Protection Agency
US FDA	United States Food and Drug Administration
USPTO	United States Patent and Trademark Office
USTMA	U.S. Tire Manufacturers Association
UTQGS	Uniform Tire Quality Grading Standards
VOC	Volatile Organic Compound
WA DOE	Washington State Department of Ecology

Executive Summary

Effective October 1, 2023, The California Department of Toxic Substance Control (DTSC) listed motor vehicle tires containing N-(1,3-dimethylbutyl)-N'-phenyl-p-phenylenediamine (6PPD) as a "priority product" under the Safer Consumer Products (SCP) Regulations.

This Stage 1 Alternatives Analysis (AA) report was prepared under the SCP Regulations on behalf of a Consortium¹ comprising some, but not all, manufacturers of the Priority Product for sale in California. As conceived by Gradient and the Consortium, the initial goal of an AA is to answer the following question: Do potentially safer, functionally acceptable, and technically feasible alternatives to the Priority Product exist that should be given a more in-depth consideration to determine if they qualify as acceptable alternatives?

This Stage 1 AA was based on available information and sought to determine whether there are possible alternatives to the priority product that should be considered in greater depth to evaluate if they are suitable alternatives to replace the priority product under regulatory guidelines (CalDTSC, 2017a). Important elements of this work were considering the requirements (legal, regulatory, or otherwise) for the priority product, determining the function of the chemical of concern in the priority product, determining whether simple elimination was possible and assessing relevant factors to identify those that would suggest a material difference exists that could affect the decision as to whether a possible alternative is a suitable replacement for the priority product. This last element required compiling extensive information on the potential hazards, potential performance, and chemical and physical properties of the possible alternatives.

6PPD is used in tires as an antidegradant, protecting the components of the tire from attack by ozone, oxygen, thermal degradation, and mechanical fatigue, *etc.* In late 2020, it was first reported that when it reacts with ozone, 6PPD forms a degradation product, 6PPD quinone (6PPDQ) (Tian *et al.*, 2021); this reaction with ozone is part of the way in which 6PPD protects tire rubber from degradation. Without 6PPD, tires will quickly develop cracks and fractures as the rubber polymer is degraded. The antidegradant function of 6PPD in tires is therefore essential to their safe use, and elimination of 6PPD without replacement is not an option.

One way 6PPD and 6PPDQ may enter the environment is through tire and road wear particles (TRWP), which are produced as the tire grips the road surface during driving. Some 6PPD and 6PPDQ on the tire surface may also be washed off the tire by rain or vehicle washing. US EPA has also noted uncertainty about levels of 6PPDQ exposure to the environment from tires relative to other potential sources (Freedhoff, 2023).

Recent laboratory studies stated that 6PPDQ is acutely toxic to coho salmon, and those studies suggest that 6PPDQ exposure from stormwater runoff, under certain conditions, may result in mortality of these fish in streams and rivers located near roadways (Tian *et al.*, 2021). In its Product-Chemical Profile for 6PPD in motor vehicle tires (CalDTSC, 2022), DTSC notes that "Behavioral symptoms of URMS [Urban Runoff Mortality Syndrome] occur within a few hours of exposure to urban runoff and include 'erratic surface swimming, gaping, fin splaying, and loss of orientation and equilibrium' (Scholz *et al.*, 2011)."

¹ The Consortium refers to the group of Responsible Entities that prepared this Stage 1 AA in accordance with the SCP Regulations.

Some other salmonid species may be similarly affected under similar circumstances, although with lower toxicological potency than coho, while other species apparently exhibit negligible toxicological susceptibility (see for example Brinkmann *et al.*, 2022; Hiki and Yamamoto, 2022; Greer *et al.*, 2023a). Studies have shown that the closely related Chinook salmon (see for example Lo *et al.*, 2023) and sockeye salmon (see for example, Greer *et al.*, 2023a) are much less susceptible.

The biological mechanisms by which the toxicity occurs, and why it affects some species and not others, is not yet known but is the subject of active research. To date, scientific studies report that coho salmon remain the most sensitive of the species examined (*e.g.*, Brinkmann *et al.*, 2022; Lo *et al.*, 2023; Foldvik *et al.*, 2024). In its Product-Chemical Profile for Motor Vehicle Tires Containing 6PPD, DTSC provides a number of possible mechanisms of action for 6PPDQ causing URMS but notes that these require further study (CalDTSC, 2022). With respect to non-aquatic toxicity, DTSC also notes that, "6PPD has been shown to be acutely toxic through oral and dermal routes of exposure in animal [*e.g.*, rodent] studies, although at relatively high dosages" but that, "[n]o studies are currently available to evaluate the human health effects of 6PPD-quinone exposure."

It is important to note that while vehicle tires are large consumers of 6PPD, 6PPD is also used in other rubber products. Additionally, tire manufacturers began using 6PPD in tire manufacturing in the mid-1960s to early 1970s. However, significant declines in the coho salmon populations in California were observed as early as the 1940s, pre-dating the use of 6PPD in tires by several decades (California Dept. of Fish and Game, 2002).

In this Stage 1 AA we considered several different types of alternatives to 6PPD as an antidegradant in tires: (1) other phenylene diamines (PPDs) that are the most logical and possibly easiest to implement alternatives to 6PPD, and (2) non-PPD alternatives that likely pose greater challenges in terms of incorporation into tire chemistry.

For all of the alternatives under consideration, information is incomplete regarding their potential hazards to coho and other fish species, although for many alternatives, data are available on other types of hazards to determine if those alternatives are unsuitable. Similarly, for some of the alternatives, initial bench scale data on performance as an antiozonant is available but definitive data on the ability to use the possible alternative in manufacturing a tire and data on the performance of that tire in all of the required tests are lacking. At this point in time, we can state that seven materials – 7PPD, IPPD, 77PD, CCPD, specialized graphene² (*e.g.*, PropheneTM), octyl gallate, and Irganox 1520 – warrant further evaluation as potential alternatives.³ Consequently, since there do appear to be possible alternatives that merit additional consideration, a two stage AA as described by the SCP regulations is appropriate. It is expected that additional data will become available within the time frame of the second stage AA that will allow for a more detailed evaluation of a suitable alternative(s).

As required by the SCP regulations, the following is a summary of information contained in each section of the stage 1 AA report.

- **Section 1** identifies the persons who oversaw the preparation of this report.

² The materials referred to as graphene in this report are graphene-based materials (sometimes referred to as a graphene nanoplatelet) with a surface area not greater than 180 m²/g, and a carbon content greater than 99% and an oxygen content less than 1%. The lateral particle size of these materials is between 100 nm and 5 µm.

³ This preliminary alternatives analysis outlines the process to assess whether alternatives can replace chemicals or technologies of concern based on their hazards, performance, and exposure potential. The term "hazard" as used throughout this document is used in keeping with the relevant guidance documents.

- **Section 2** identifies the Consortium members submitting this report and addresses how they will be submitting supply chain information as a separate confidential business information (CBI) submittal.
- **Section 3** identifies the Priority Product (motor vehicle tires containing 6PPD) and the chemical of concern (6PPD). Tables listing the manufacturers and their priority products, consistent with the product names on the submitted Priority Product Notifications (PPNs), are also included as appendix B. Section 3 identifies the function of the chemical of concern in the Priority Product (*i.e.*, antidegradation). Section 3 also discusses the many performance requirements of motor vehicle tires and identifies tests that are conducted to evaluate this performance. Key performance criteria include static and dynamic antioxidant and antiozonant operation modes, including but not limited to high speed performance, rolling resistance, endurance, wear rate, and traction in dry, wet, and snow conditions. Some of these performance criteria are related to product safety and are mandated by federal regulations. Other performance criteria are related to vehicle fuel efficiency or customer expectations (*e.g.*, tire warranty, ride comfort). Section 3 concludes with a discussion of how removal of 6PPD from tires without a functional replacement is not possible and thus an alternative performing the same function is required.

Section 4 begins with a scoping discussion that describes technologies that fall outside the scope of this AA. Alternative tire technologies, such as non-pneumatic tires, are not suitable alternatives because they would also require the use of antidegradant chemicals in their rubber compounds or cannot be currently mandated or implemented by tire manufacturers. Some of these technologies are currently theoretical and have not been demonstrated to be useable for cars, trucks, or buses. A second non-viable option is a particle collector system which would reduce, somewhat, the load of particles emitted during tire use. This option is not suitable because it is beyond the ability of tire manufacturers to mandate such technologies and also because the technology's effectiveness in reducing migration of 6PPD to the environment appears limited. Although reduction in exposure potential does constitute a viable alternative under the SCP regulations, it is not clear that this technology could reduce exposure to the extent that would be considered meaningful. A third non-viable option involves waxes and coatings. When used alone, waxes and coatings can only protect tires from ozone under static conditions. While cars are in motion (*i.e.*, dynamic ozone conditions), waxes and coatings wear off almost immediately and expose the underlying rubber to ozone attack, which causes earlier failure. DTSC's Product-Chemical Profile (CalDTSC, 2022) noted that waxes and coatings are "likely infeasible means of protecting the tire tread." Section 4 next discusses how information was obtained to identify possible alternatives to 6PPD in motor vehicle tires and the criteria used to select a subset of possible alternatives for further evaluation in this Stage 1 AA. Following this approach, over 70 candidate alternatives for 6PPD were identified (Appendix F). The section describes how each of these possible alternatives was screened and scored in terms of its likely feasibility as an antiozonant and how those that appeared promising were selected for full evaluation in this Stage 1 AA. Possible alternatives with compound effectiveness against ozone scores of 3 or 4 were evaluated further in this preliminary (Stage 1) AA. However, all possible alternatives suggested by DTSC in the Priority Product profile (CalDTSC, 2022) and all possible alternatives listed on DTSC's website (CalDTSC, 2024), including but not limited to those possible alternatives suggested by the Washington State Department of Ecology (WA Ecology, 2021) were retained for this Stage 1 AA, irrespective of their compound effectiveness against ozone score. Overall, a total of 43⁴ possible alternatives were evaluated further in this Stage 1 AA, including 19 other phenylene diamines (PPDs) and 24 non-PPD based antidegradants.

⁴ While waxes and coatings were carried from Appendix F into the Stage 1 AA because they were suggested by DTSC, they were not evaluated further for hazards, exposure, and performance because they are non-viable alternatives when tires are in motion. Thus, they did not contribute to the count of possible alternatives evaluated in this Stage 1 AA. See Section 4.4 for more discussions on waxes and coatings.

Section 4 concludes with a discussion of factors that were considered to be relevant to this Stage 1 AA. It includes a discussion of conceptual exposure models that show how individuals and environmental receptors may be exposed to 6PPD across the tire product life cycle. It also describes what is known regarding the relevance of each life cycle aspect noted in the SCP regulations to the evaluation of different alternatives. A life cycle assessment (LCA) is available for tires but is not available for 6PPD nor for any of the possible alternatives, making quantitative comparisons among the alternatives to determine whether there is a material difference impossible. More qualitative arguments, based on raw materials used in manufacturing 6PPD and the alternatives, their chemical properties and the required properties of any alternative (*e.g.*, lifespan of the product, ability to be recycled or repurposed) suggest that for the use, waste generation, recycling/reuse and end of life portions of the product lifecycle, there do appear to be potential material differences among the priority product and possible alternatives but this would need to be further explored in Stage 2. For other life stages (*i.e.*, raw materials extraction, intermediate materials processing, product manufacturing, product packaging, and operation and maintenance) there are unlikely to be material differences between the Priority Product and the possible alternatives. For the remaining life cycle stages (*i.e.*, resource consumption and distribution) it is unclear whether there will be differences among products because relevant data for the possible alternatives are lacking.

- **Section 5** begins with a review of health hazard information for the Priority Product and the possible alternatives. Overall, all of the alternatives involve reactive molecules, which was anticipated given that the requirement is for a chemical that can scavenge ozone and oxygen. We obtained data on the hazards of the possible alternatives from two primary data sources – European Chemicals Agency (ECHA) Registration, Evaluation, Authorization and Restriction of Chemicals (REACH) dossiers and GreenScreens[®] conducted by ToxServices for the State of Washington, Department of Ecology. Using an adaptation of a published scoring approach, we found that 24 of the 43 possible alternatives had insufficient data to assign a hazard score. Of the 19 possible alternatives with sufficient data, 6 had total scores estimating at least 30% potential hazard reduction relative to 6PPD. These 6 chemicals included 1 PPD (77PD) and 5 non-PPDs (DLTP, TAPDT, specialized graphene, octyl gallate, and Irganox 1520). Four of these possible alternatives had hazard scores that were an order of magnitude better than 6PPD: DLTP, specialized graphene, octyl gallate, and the Irganox 1520. Note that a reduction in hazard alone does not define an appropriate alternative.

In addition to the hazard scoring, we researched and tabulated available information about the potential of the possible alternatives to affect coho salmon or related salmonid species. Data on this subject are extremely limited. Concentrations lethal to 50 percent of the population (LC₅₀) in salmonids were available for eight of the possible alternatives (6QDI, 77PD, DTPD, CCPD, DAPD, NBC, ethoxyquin, and N-phenyl-1-naphthylamine). Two studies evaluated the quinone transformation products of five possible alternatives (77PDQ, CPPDQ, DPPDQ, DTPDQ, and IPPDQ). These studies suggest there may be lower acute toxicity of 77PDQ, CPPDQ, DPPDQ, DTPDQ, and IPPDQ relative to 6PPDQ, however, these results are preliminary and unconfirmed.

Section 5 also discusses the preliminary and unpublished results of testing commissioned by USTMA and conducted by the US Geological Survey (USGS). This testing used *in vitro* (isolated cell) systems to study the potential toxicity of 6PPD and a small number of alternatives (the number of alternatives was limited so as to be able to have data to consider in the Stage 1 AA). The results of that testing showed differential toxicity relative to 6PPD, providing a preliminary indication that not all PPDs pose the same degree of hazard to coho as 6PPD.

We also explored potential environmental transformation products of the possible alternatives and examined their chemical and toxicological properties. Using ECHA dossiers as the source of

transformation product information, we found that a number of PPDs likely share the same potential breakdown products as 6PPD (*e.g.*, aniline and p-benzoquinone). The extent to which transformation actually occurs from antidegradant in TRWP is unknown. For many of the possible alternatives, transformation product information was not available in the ECHA dossier. This lack of information represents a significant uncertainty in the AA and will need to be addressed in Stage 2.

Section 5 next discusses product performance. Performance information was grouped into three different source categories: historical data from patents and other information published before 2020 (the year the Tian *et al.* [2021] publication first appeared on-line); data from recent bench scale testing of a few alternatives by Flexsys (the same alternatives tested by USGS); and recent data from patents or other sources published in 2020 up to January 2024. In tables relevant to each category, the findings for each alternative regarding potential performance are summarized and the citation to the relevant study is provided. We characterized the performance data into the following four categories:

- **Some promising ozone data.** These possible alternatives had positive data regarding ozone performance in screening level tests (*i.e.*, bench scale testing, not in finished tires).
- **Limited ozone data.** These possible alternatives had some positive data for ozone performance in screening level tests but there were some concerns about the study, often a lack of an appropriate control or a lack of information about controls.
- **Insufficient data, no ozone data.** The chemical lacks any data related to performance as an antiozonant. Note that a chemical having positive data as an antioxidant does not indicate the chemical can perform as an antiozonant (Akrochem, 2010).
- **Poor ozone performance.** For these possible alternatives, the available data indicate the chemical does not perform as an antiozonant or performs poorly compared to 6PPD.

Those possible alternatives that have either some promising ozone data or limited ozone data were considered to have acceptable preliminary performance and suitable for Stage 2 if they also met other Stage 1 AA criteria. Note that an indication of promising or limited ozone performance in screening type tests alone does not define an appropriate alternative.

Those possible alternatives that have either some promising ozone data or limited ozone data are eligible to be included in the Stage 2 AA if they also have hazard information.

Section 5 concludes with a review of relative exposure information for the Priority Product and the possible alternatives. We gathered chemical specific physiochemical data for all of the alternatives, as suggested in CalDTSC's "Alternatives Analysis Guide" (CalDTSC, 2017a). Some of the possible alternatives have substantially less water solubility than 6PPD (*e.g.*, DOPD, DLTP, RU997, and TAPDT) which could affect their environmental partitioning. Similarly, some have substantially higher log K_{ow} values (an indication of partitioning into organic materials) than 6PPD (*e.g.*, DLTP, Ru997/Irgazone 997 blend, TAPDT, and DOPD) which again could result in different environmental behavior. Some also have substantially different vapor pressures (some higher, some lower) which could affect workplace exposures. While this evaluation provided some insight into the ingredient-level exposure potential of the possible alternatives, ideally, we would compare the product-level exposure data, because the ingredients are meant to react and create a structure that is distinctly different from the individual ingredients. Because the relative importance of mobility in one environmental medium *versus* another is not clear, no product-level exposure information is available at this time for any alternative.

- **Section 6** presents the conclusions of the Stage 1 AA. This section describes how information on chemical hazard, performance, and exposure potential, described in detail in Section 5, are aggregated into an overall comparison table (Table 5.15) and used to determine whether a particular possible alternative should be further evaluated in the Stage 2 AA. Chemicals selected for evaluation in Stage 2 had (1) similar or reduced overall hazard relative to 6PPD based on the available information, (2) screening level performance data indicating a potential to perform in tires as an antiozonant (*i.e.*, some promising ozone data or limited data), and (3) acceptable physical/chemical properties indicative of exposure potential. The seven chemicals that met these criteria were: 7PPD, IPPD, 77PD, CCPD, a specialized graphene, octyl gallate, and Irganox 1520. Twenty-four of the 43 alternatives evaluated were eliminated from further consideration in Stage 2 because they have complete hazard data gaps. The remaining 12 possible alternatives were eliminated due to a lack of performance data or because available data indicated they would not perform well against ozone. Because the Stage 1 AA determined there were possible alternatives to the Priority Product, the report concludes that a Stage 2 AA is appropriate.
- **Section 7** discusses the proposed Work Plan for the Stage 2 AA. This includes a table of expected timing for meetings with DTSC and the types of additional information that will be gathered to support the Stage 2 assessment.
- **Section 8** discusses uncertainties encountered in preparing this Stage 1 AA and the potential implications these may have for the results of the Stage 2 AA. For example, any potential acute aquatic toxicity hazards reported in salmonids may not represent potential hazards or risk associated with their presence in a final vehicle tire product, as any potential hazard of these chemicals is dependent upon their potential migration from vehicle tires and TRWP, which if any, remains unclear. This section also includes suggestions for how these uncertainties can be reduced in the Stage 2 analysis.
- **Section 9** lists the report references.

Appendices providing some of the supporting data and other relevant information are included at the end of the report.

1 Preparer Information

Preparer Information:

First Name	Tracey
Last Name	Norberg ⁵
Job Title	Executive Vice President & General Counsel
Company	U.S. Tire Manufacturers Association (USTMA)
Email	tnorberg@ustires.org
Phone	202.682.4800
Address	1400 K Street, NW #900, Washington, DC 20005

⁵ Submitting on behalf of a Responsible Entity group comprised of the responsible entities listed here.

2 Consortium Members and Supply Chain Information

USTMA 6PPD Alternatives Analysis Consortium Membership

() indicates name(s) used for PPN if different

American Kenda Rubber Industrial Co., LTD (America Kenda Rubber Ind Co.)
Apollo Tires (US) Inc. (Apollo Tyres Limited)
Bridgestone Americas, Inc.
CEAT Ltd.
China Manufacturers Alliance, LLC
Continental Tire the Americas, LLC
GITI Tire (USA), Ltd. (Giti Tire)
Hankook Tire America Corp.
Hebei Wanda Tyre Co., Ltd.
Jiangsu General Science Technology Co., Ltd.
JK Tyre & Industries Limited
Kumho Tire U.S.A., Inc. (Kumho Tire)
Linglong Americas, Inc.
Maxxis International – USA (Maxxis Technology Center) (Cheng Shin USA Tech Center)
Michelin North America, Inc. (+ PT. Multistrada Arah Sarana Tbk)
Nexen Tire America, Inc. (Nexen Tire Corporation)
Nokian Tyres Inc. (Nokian Tyres US Operations LLC)
North American Commercial Tire Resources Inc. (Guizhou Tyre Co., Ltd.)
Otani Radial Tire Co, Ltd and Otani Tire Co, Ltd
Pirelli Tire LLC
Prinx Chengshan Holdings, Ltd
Prometeon Tyre Group Commercial Solutions, LLC
Qingdao Sentury Tire Co., Ltd.
Sailun North Americas (Sailun Group Co., Ltd)
Shandong Haohua Tire Co., Ltd
Shandong Jinyu Tire Co., Ltd
Sumitomo Rubber Industries, Inc.
The Goodyear Tire & Rubber Company
Tianjin Wanda Tire Group Co., Ltd
Toyo Tire Holdings of Americas Inc.
Triangle Tyre Co., Ltd
Yokohama Tire Corporation (+ Yokohama TWS North America, Inc.)
ZC Rubber America Inc.

Information regarding supply chain is being submitted to DTSC by USTMA as confidential business information and is not included in this report.

3 Priority Product Information

3.1 Priority Product Made by Consortium Members Participating in This Alternatives Analysis Report

This Consortium comprises some but not all manufacturers of motor vehicle tires containing 6PPD. Products made by these responsible entities that fall within the scope of the priority product listing are shown in Appendix B. Requirements under 29 CFR § 1910.1200 to provide a Safety Data Sheet (SDS) do not apply to tire manufacturers for a new, finished tire, since a new tire is an article as defined in 29 CFR § 1910.1200(c). Therefore, to meet the requirement in 22 CCR § 69505.7(e)(4) to provide "any Material Safety Data Sheets and/or Safety Data Sheets related to the Priority Product," we are providing as an example a Safety Data sheet for Santoflex™ 6PPD Pastilles prepared by Flexsys (Appendix C), which is publicly available on the Flexsys website. We are aware that 6PPD may be available in other forms, including liquid form, and that other 6PPD suppliers would have their own SDSs. This SDS is intended as an example to meet the regulatory requirement.

3.1.1 Overview of Motor Vehicle Tire Composition and Manufacturing

Tires⁶ are the only part of a vehicle that contacts the road, and that connection is vital in helping to keep motorists safe. Tires play an essential role in vehicle safety by transferring the driver's inputs from the vehicle to the road. Additionally, tires support the weight of the vehicle, facilitate steering for maintaining vehicle control, grip the road for acceleration and braking, and must perform in a variety of weather conditions. Tires are highly engineered products whose performance must meet applicable Federal Motor Vehicle Safety Standards, vehicle manufacturers' ride, handling, and traction criteria, rolling resistance requirements important in meeting fuel efficiency targets, and customer expectations for quality and performance.

The product the public knows as a tire is formed from various components (*e.g.*, sidewall, tread, inner liner). These components are in turn composed of different compounds, that is, mixtures of rubber polymers, also known as elastomers, and various additives. The tire components also include materials such as textile or steel cords. An important aspect of the tire is its use of vulcanized rubber. Vulcanization is a process in which heat is applied to the "green", or uncured, rubber compound causing a chemical reaction among sulfur, other chemicals, and polymers (elastomers) in the rubber compound. These reactions result in chemical bonds (cross links) between the polymer (elastomer) chains to produce cured tires.

The general structure of a passenger car tire, including some key components, is shown in Figure 3.1, and the typical structure of a radial medium commercial truck and bus tire is shown in Figure 3.2.

⁶ As used in this document, "tire" means a pneumatic radial tire used with motor vehicles (*e.g.*, passenger cars and light duty trucks, motorcycles, and heavy duty trucks and buses).

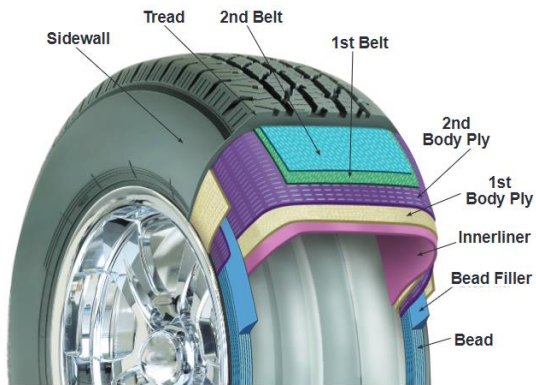

Figure 3.1 Typical Construction Features of a Pneumatic Radial Passenger Car Tire. Source: USTMA, 2017a

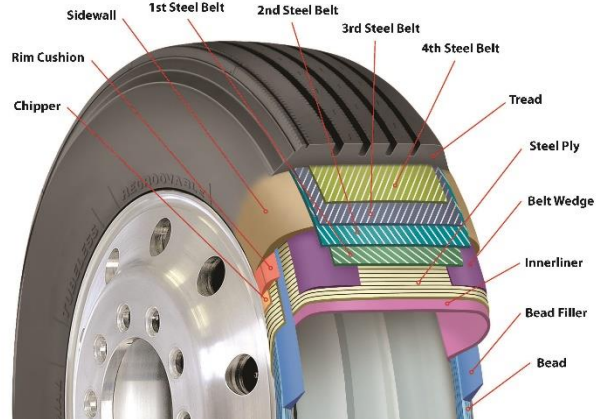

Figure 3.2 Typical Construction Features of a Pneumatic Radial Medium Commercial Truck/Bus Tire. Source: USTMA, 2017b

An explanation of some key tire components and the function they serve in a tire is given below.

- **Bead:** The tire bead is the portion (or component) of the tire that sits on the rim of the wheel. Tire beads are steel wire bundles that are coated with a specific rubber compound and secure the tire to the metal wheel.
- **Bead Filler:** A rubber compound placed above the bead that may be used between the body plies which wrap around the bead to enhance ride and handling characteristics.
- **Belts:** Typically, two belts with steel cords laid at opposing angles form a hoop under a tire's tread. Belts provide stability to the tread area of the tire, which minimizes wear and contributes to vehicle handling and traction. The steel belt is coated with a rubber compound that is called a belt coat or belt skim compound.
- **Body Plies:** Most car tires have one or two body plies, each typically comprised of textiles cords within a rubber layer. Truck and bus tires typically use steel cords for body plies. Body plies function as the base structure of the tire and provide the strength to contain the inflation pressure.
- **Inner liner:** A rubber compound used to retain the inflation pressure inside the tire.
- **Sidewall:** A rubber compound used to cover the body plies on the sides of the tire, which provides abrasion, scuff, and weathering resistance.
- **Tread:** Located on the road contacting portion of the tire, the tread rubber compound and tread pattern provide grip and abrasion resistance contributing to traction and treadwear.

All of these components have to be permanently bonded together in order for the tire to function properly and safely.

3.1.1.1 Tire materials and tire compounding

As noted above, each of the components of a tire are composed of uniquely formulated rubber compounds and may include reinforcing materials such as steel and textiles. Compounding, the science of selecting and combining materials for a specific tire component, is complex. Categories of materials used in tire compounding include the following:

- **Natural Rubber:** Natural rubber provides specific performance characteristics to tires, such as tear and fatigue crack resistance. Some tires, especially truck and bus tires, use natural rubber in tread compounds to provide reduced rolling resistance (the resistance the tire encounters when rolling down the road, an important consideration for fuel efficiency). Natural rubber is a form of polyisoprene which is obtained by tapping rubber trees (*Hevea brasiliensis*).
- **Synthetic Polymers:** The two main synthetic rubber polymers, or elastomers, used in tire manufacturing are butadiene rubber and styrene butadiene rubber (SBR). These synthetic rubber polymers are used in combination with natural rubber. The physical and chemical properties of these rubber polymers determine the performance of each component in the tire as well as the overall tire performance. Another important synthetic rubber is halogenated polyisobutylene rubber, commonly known as halobutyl rubber, which is used in the inner liner. This material causes the inner liner to have reduced air permeability, which helps to keep the tire inflated.
- **Fillers:** Multiple grades of carbon black and coupled/uncoupled precipitated amorphous silica are used as fillers to reinforce the rubber and modify its properties resulting in improved wear performance and traction.
- **Antidegradants:** Antidegradants are added to rubber compounds to protect tires from overly rapid deterioration by ozone, oxygen, fatigue, and heat. Antidegradants include both antioxidants, which help to keep rubber from breaking down due to the effects of temperature and oxygen exposure, and antiozonants, which are used to impede the effects of exposure to ozone on the surface of the tire. Antidegradants in tires must serve in two load performance conditions, static and dynamic operations modes, which describe when the tire is at rest or flexing under motion, respectively.
- **Processing aids:** Bio-based oils, low aromatic petroleum oils, pine tar, and resins are the most common softening agents used in rubber compounding. Tackifying resins can be added to increase the rubber compound stickiness (tack) which helps the various tire components stick together during assembly of tire components.
- **Curing Systems:** Sulfur, chemical accelerators (often derivatives of benzothiazole), stearic acid, and zinc oxide are crucial ingredients for vulcanization, which transforms soft uncured rubber into a solid elastic article during tire curing. Curing systems not only enable vulcanization, but also shorten the vulcanization time and impact the length and number of crosslinks in the rubber matrix which in turn affects the rubber's properties.

Rubber compounds are uniquely formulated for the performance requirements needed for each tire component. For example, the rubber compound for the inner liner component of a tire is formulated to hold air inside the tire at the correct pressure when inflated; this requires specific polymers and ingredients that are unique to that purpose. The rubber compound for the tread component of a tire contacts the road, so it is formulated to meet performance expectations such as grip, wear, wet traction, snow traction, fuel efficiency, and other tire performance needs.

3.1.1.2 Tire manufacturing processes

The tire manufacturing process begins with the selection of polymers, fillers, oils, and other ingredients such as antidegradants, that will combine into a rubber compound to provide the exact characteristics wanted for the specific tire component. A machine called a Banbury[®] mixer combines the various raw materials for each compound into a homogenized batch of black material with the consistency of chewing

gum. The mixing process is computer-controlled to ensure batch-to-batch consistency. The compounded materials are then sent to machines for further processing into tire components such as sidewalls, belts, body plies, treads, or other parts of the tire.

The various tire components then come together in a machine where the tire is built from the innermost layer to the outermost layer. The uncured tire, often referred to as a "green tire" in the tire industry, is then placed inside a hot mold and inflated to press it against the mold, forming the tread pattern and the sidewall features. The tire is then vulcanized by heating it to more than 300 degrees Fahrenheit (150 degrees Celsius) for a pre-specified time which causes chemical reactions which transform the various tire components to form a finished tire.

For additional details around each specific component and their functions please see the free National Highway Traffic Safety Administration (NHTSA) resource "The Pneumatic Tire" (US DOT, 2006).

Tire manufacturing also involves compliance with various environmental and occupational safety regulations. For example, factories typically require air and water emissions permits and must comply with federal Occupational Safety and Health Administration (OSHA) regulations. For manufacturing facilities located in California, workplace warnings must be given if facilities use chemicals listed under California's Proposition 65.

3.1.2 Different Types of Tires

3.1.2.1 Passenger car and light truck tires

Passenger and light truck tires are the predominant tires in the US (see Table 3.1, below). Passenger and light truck tires can be categorized as OE (Original Equipment) which are supplied on a vehicle at its time of purchase, or replacement tires. OE tires must meet specific, often numerous and complex performance requirements specific to the vehicle manufacturer. OE tires are designed to a specific vehicle model year/make/model/trim level combination, and any changes to the materials used to manufacture OE tires, or the tire design itself, would require approval from the vehicle manufacturer. OE tires typically do not come with treadwear warranties.

Tires designed for the replacement market ("replacement tires") are designed to perform well on a wide range of vehicles – often as many as 30 different vehicle applications are appropriate for a single tire service description (tire size/speed rating/load index combination). Passenger and light truck replacement tires can be installed by a tire dealer or other tire service professional without original equipment manufacturer (OEM) approval. In the replacement market, consumers typically demand optimized treadwear and wet traction performance. In the replacement market, tire price also is a key consideration for consumers in many cases.

According to the DTSC's Product-Chemical Profile, "'motor vehicle tire' does not mean a motor vehicle on which tires have been installed" (DTSC, 2023). Tires installed on new vehicles are not part of the Priority Product definition. OE tires are considered replacement tires due to requirements in OE contracts for OE tires to be available as replacements, customer demand for OE tires in the replacement market, and to manage excess OE tire inventory. For purposes of this Stage 1 AA, OE tires are considered to be a subset of the replacement tire market and included in the analyses.

Table 3.1 U.S. Tire Industry Shipments Summary

2023 U.S. TIRE INDUSTRY ACTIVITY SUMMARY							
Shipments							
<i>(in thousands of units)</i>							
		2022		2023		% Change 23/22	
		Total	Radial	Total	Radial	Total	Radial
Passenger							
	<i>Industry Original Equipment</i>	41,616	38,817	45,657	42,723	9.7%	10.1%
	<i>Industry Replacement</i>	213,730	213,184	219,180	218,637	2.5%	2.6%
	USTMA Exports	13,962	13,932	14,462	14,412	3.6%	3.7%
	Total Passenger	269,308	265,933	279,299	275,771	3.7%	3.7%
Light Truck							
	<i>Industry Original Equipment</i>	6,260	6,250	5,856	5,846	-6.5%	-6.5%
	<i>Industry Replacement</i>	37,241	37,082	34,253	34,162	-8.0%	-7.9%
	USTMA Exports	4,349	4,349	3,842	3,842	-11.6%	-11.6%
	Total Light Truck	47,849	47,680	43,952	43,851	-8.1%	-8.0%
Truck & Bus							
	<i>Industry Original Equipment</i>	6,487	6,487	6,218	6,218	-4.1%	-4.1%
	<i>Industry Replacement</i>	26,652	26,508	20,777	20,670	-22.0%	-22.0%
	USTMA Exports	2,026	2,026	1,944	1,944	-4.0%	-4.0%
	Total Truck & Bus	35,164	35,021	28,938	28,831	-17.7%	-17.7%

Notes:

Source: USTMA, 2024

Passenger and light truck replacement tires can also be divided into additional performance categories including all-season, summer, snow/winter tires, and a newer category of all-weather tires. All-season passenger and light truck tires are the most common tire type in the US and, as the name suggests, are general-purpose tires designed to perform in most climates. All-season passenger replacement tires typically come with a wear warranty from the tire manufacturer, typically in the 50,000- to 80,000-mile range. Antidegradants are a critical factor in allowing a tire to achieve these long mileage warranty periods.

Passenger and light truck tires have similar construction and utilize similar materials. However, light truck tires are designed to carry higher loads at higher inflation pressures, which requires the use of thicker rubber components, higher strength textiles and steel, and multiple body plies.

3.1.2.2 Truck and bus radial tires

Truck and bus radial tires differ in construction from passenger and light truck tires because the demands for truck and bus radial tire performance are more severe. Truck and bus radial tires contain steel cords as their body plies, instead of the textile plies found in passenger and light truck tires, and typically contain three or four steel belts rather than the two typically seen in passenger car and light truck tires. Depending on the application and type of service, truck and bus radial tires can last up to 150,000-300,000 miles on their original tread. Tires which are used for commercial purposes are designed to be retreaded, which is a

process to replace the tread on the tire casing. A truck and bus radial tire body (also known as a casing or carcass) may be retreaded up to three times and may last up to a total of 750,000 miles. Because the life cycle of truck and bus radial tires is much longer than that of a passenger or light truck tire, truck and bus radial tire rubber compounds typically contain higher levels of antiozonants/antioxidants (*i.e.*, 6PPD).

3.1.2.3 Motorcycle tires

Motorcycle tires differ in construction from both passenger and light truck tires and truck and bus radial tires due to the varying demands of the different types of motorcycles which are in use. A typical motorcycle tire for on-road application has a tread life ranging from 10,000-15,000 miles, depending on the motorcycle, driving style, and road surfaces encountered.

3.2 Chemical of Concern for the Priority Product

The chemical of concern for the Priority Products is N-(1,3-dimethylbutyl)-N'-phenyl-p-phenylenediamine (6PPD), Chemical Abstract Service Registry Number 793-24-8. 6PPD is within the class of PPDs and is the main antidegradant used in tires (Figure 3.3).

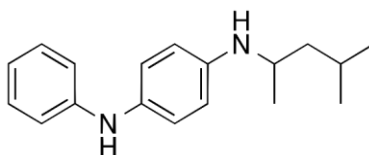

Figure 3.3 Chemical Structure of 6PPD

6PPD is used to protect tires from deterioration due to fatigue, thermo-oxidative breakdown, and from exposure to environmental degradation agents such as ozone and oxygen. These environmental degradation agents will attack the exposed tire surface and cause cracks and hardening of the rubber component throughout the tire's lifetime. In addition to the tire surface, interior portions of the tire (*i.e.*, the tire belt coat compound) can be attacked by oxygen diffusing from air inside the tire and penetrating through the grooves of the tire tread.

6PPD reacts with environmental degradants, ozone, and oxygen, faster than these degradants can react with the rubber or by quenching the reactive products of degradants and rubber, which protects the rubber products from degrading. As 6PPD reacts with the degradants, it is consumed, leaving less 6PPD in the tire. All tire compounds, except the inner liner and white rubber compounds (where used as sidewall decoration, lettering, or symbols), currently contain 6PPD as an essential antidegradant. It is important to note that 6PPD is currently used in all Consortium member passenger, light truck, truck and bus radial, and motorcycle tires. The Consortium is not aware of any motor vehicle tires available today that are 6PPD-free.

The adoption of the use of 6PPD in tires was a gradual process. Tire manufacturers began using 6PPD in tire manufacturing in the mid 1960's and early 1970's. In 1969, a British patent was published regarding the manufacturing of the 6PPD molecule (Davies and Neale, 1969). By 1975, 6PPD comprised 60% of the antiozonant used in tires (other, less effective PPDs were used previously)⁷ (US EPA, 1975).

⁷ The first PPDs developed were active antiozonants but they were not as effective as 6PPD as they did not provide protection of rubber compounds for more than one and a half years. IPPD and DAPD were the first to be used in rubber compounds in the mid-

6PPD can transform into a number of reaction products when it carries out its intended function and reacts with ozone and oxygen. The reaction product of primary interest in this AA is 6PPD-quinone (6PPDQ, Figure 3.4), which was identified for the first time in December 2020 (Tian *et al.*, 2021). This same paper also suggested a link between this newly discovered substance and potential impacts to coho salmon (*Oncorhynchus kisutch*) attributed to roadway stormwater runoff. In their publication, Tian *et al.* (2021) state: "Exposures to ozone-synthesized and tire leachate-derived 6PPD-quinone (~20 ug/liter nominal concentrations) both induced rapid (<5 hours, with initial symptoms evident within 90 min) mortality...which matched the 2 to 6 hours mortality observed for positive controls." Similar findings in other laboratory studies were subsequently reported by other researchers (*e.g.*, Lo *et al.*, 2023). It should also be noted that significant declines in the coho salmon populations in California were observed since the 1940s, pre-dating the use of 6PPD in tires by several decades (California Dept. of Fish and Game, 2002).

Some other salmonid species may be similarly affected under similar circumstances, although with lower toxicological impacts than to coho, while other species apparently exhibit negligible toxicological susceptibility (see for example Brinkmann *et al.*, 2022; Hiki and Yamamoto, 2022; Greer *et al.*, 2023a). Multiple studies have shown that the closely related Chinook salmon are much less susceptible. For example, Lo *et al.* (2023) reported that "Juvenile coho were 3 orders of magnitude more sensitive to 6PPD-quinone compared with juvenile Chinook, with 24-h median lethal concentration (LC₅₀) estimates of 41.0 and more than 67,307 ng/L, respectively."

The biological mechanisms by which the toxicity occurs, and why it affects some species and not others, is not yet known but is the subject of active research. For example, Tian *et al.* (2022) summarized the challenges of understanding the effects of 6PPDQ: "The mechanisms of toxicity of 6PPD-Q to coho salmon need to be characterized, while its toxicity, both acute and sublethal, to additional organisms needs to be broadly evaluated, including insights into mechanisms of species-specific sensitivities." Although scientific studies have continued since Tian *et al.*'s 2022 publication (*e.g.*, Foldvik *et al.*, 2022, 2024; Montgomery *et al.*, 2023; Anderson-Bain *et al.*, 2023; Ackerly *et al.*, 2024), the mechanism of 6PPDQ's effect remains unclear. Coho salmon remain the most sensitive of the species examined. In their Product - Chemical Profile for Motor Vehicle Tires Containing 6-PPD, DTSC describes a number of possible mechanisms of action for 6-PPD causing URMS but notes that these require further study (DTSC, 2022). With respect to non-aquatic toxicity, DTSC also notes that "6PPD has been shown to be acutely toxic through oral and dermal routes of exposure in animal [*e.g.*, rodent] studies, although at relatively high dosages" but that "[n]o studies are currently available to evaluate the human health effects of 6PPD-quinone exposure."

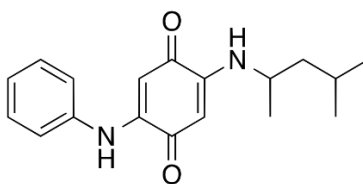

Figure 3.4 Chemical Structure of 6PPD Quinone

3.3 Function of the Chemical of Concern in the Priority Product

All tires contain antidegradants to prevent degradation of the rubber compounds caused by exposure to oxygen, ozone, fatigue, and elevated operating temperatures. Antioxidants and antiozonants are two classes

1960s. DAPD reacts minimally with ozone, and IPPD reacts too fast with ozone leading to premature depletion. The final PPDs to become commercialized were 6PPD, 7PPD, and 8PPD (Kuczkowski, J. A., 1990).

of antidegradant. There are in turn, two types of antioxidant and antiozonant performance that are important in tires: dynamic and static operation modes.

- Dynamic load performance: Antioxidants and antiozonants with dynamic operation modes protect the tire while it is in motion and being flexed;
- Static load performance: Antioxidants and antiozonants with static operation modes form a coating that protect the tire when it is in its resting and stationary state.

6PPD performs as an antioxidant and antiozonant in both dynamic and static operation modes. 6PPD reacts with ozone in the air to minimize the attack on the tire surface and reacts with the oxygen coming from the internal inflation pressure that degrades the belt rubber compound, thus preventing degradation of both the internal and external sides of the tire. Antidegradants are essential to ensure tire safety. Without the use of high-performing antidegradants like 6PPD, tire rubber compounds crack and degrade rapidly, creating potentially serious safety concerns (Figure 3.5).

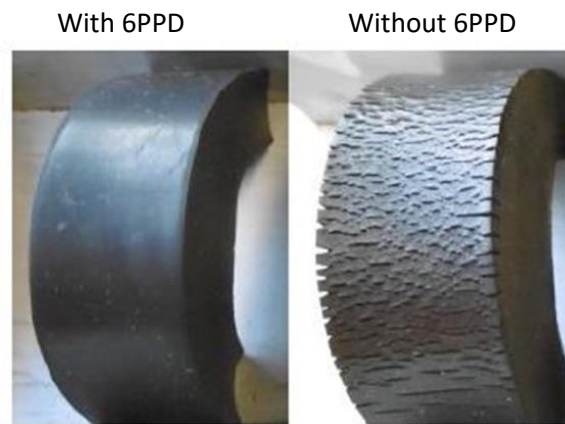

Figure 3.5 Dynamic Antiozonant Effect of 6PPD, 0.5 ppm Ozone Concentration, 40°C, 48 hours. Source: Schunk, A. 2022

The antiozonant and antioxidant properties of 6PPD are critical to creating durable tires. These properties are also important for tire longevity, leading to less demand on natural resources and energy for tire production as well as decreased tire waste. As an antidegradant reacts with degradants, its concentration in the tire is reduced; therefore, tires that are expected to last longer in the market require higher concentrations of these chemicals. 6PPD has the ability to migrate through the tire and reach the surface where it is needed to protect the tire from exposure to oxygen and ozone damage. Most importantly, the chemical migrates at the necessary rate such that the 6PPD contained in the tire can be present at the surface throughout the tire's intended lifetime. Any alternative to 6PPD would need to satisfy a similar surface availability \times time profile.

In summary, antidegradants such as 6PPD must provide the following functions:

- **Protection against ozone**
 - Readily reactive with ozone to prevent crack formation on the surface of the rubber, but not too reactive in order to prevent premature depletion
- **Protection against oxygen**

- Reactive with oxygen to prevent hardening of the rubber, loss of strength, improve tire wear, and maintain long-term durability, while not reacting so aggressively with oxygen as to cause premature depletion.
- **Protection against fatigue**
 - Reactive with the free radicals generated by breaks in rubber polymer during flexing. These free radicals can break the polymer chains and crosslinks in the rubber compound that would lead to a loss of strength for body plies, sidewall, and tread.
- **Optimal migration rate/ diffusion**
 - Adequate solubility and diffusivity in rubber compounds, also referred to as migration and mobility, which allows the chemical to move to the tire surface where it is needed to react with oxygen and ozone to ensure long term protection of the tire from oxygen and ozone damage over its life
 - Available in the rubber formulation at an effective concentration over a tire's entire life cycle to ensure protection from ozone and oxygen damage
- **Be compatible with manufacturing processes**
 - No adverse effects on the rubber cure rate, tack, viscosity, *etc.*
 - Resistance to temperatures encountered during the tire vulcanization process
- **Be compatible with other aspects of tire safety and performance**
 - The chemical cannot interfere with the function of other rubber compounding ingredients needed for safety (*e.g.*, steel belt adhesion, cornering ability)

3.4 Key Performance Requirements for the Priority Product

The California Code of Regulations (CCR) §69505.5 states that an AA "shall identify the functional, performance and legal requirements of the Priority Product that must also be met by the alternatives under consideration." There are substantial requirements that tires must meet in order to be sold on the market. These requirements may be regulatory in nature (*i.e.*, safety), manufacturer-driven, or customer-driven, such as rolling resistance, wear, and other performance attributes. In addition, tires are a globally manufactured and distributed product and therefore must comply with a wide range of regulations in multiple countries.

3.4.1 Testing of Rubber Compounds Prior to Actual Tire Development

There are many steps that are needed to evaluate tire safety and performance. Before a tire is built and assessed for performance and safety, laboratory screening tests to evaluate the performance of various tire compounds must be completed with satisfactory results. These initial screening tests are essential to ensure that only viable compounds are used in development of tire products that then have to undergo more detailed and legally required testing.

All new rubber compounds using an alternative antidegradant must be tested and compared to a "control" or "witness" containing a standard material, in this case containing 6PPD, that has been produced at the same time and handled in the same manner. This is especially true for antidegradants, which are reactive chemistries and can be consumed during processing and aging. Each formula contains a variety of raw materials, all of which have some level of allowable range of variation. The results can also be influenced by the environmental conditions during the processing steps and during the testing; for these reasons, it is critical to have a control made at the same time.

Any alternative antidegradant would also need to be tested in multiple rubber compounds per tire component because each tire manufacturer uses different tire compounds in their products depending on the tire's intended use. The reader can find examples in the published literature (see for example, the Vanderbilt handbook [Sheridan, MF, 2010]). Accordingly, the use of different tire compounds among manufacturers influences the types of tests that they need to perform in order to demonstrate that an alternative is acceptable.

Based on the critical functions of an antidegradant, a potential list of screening tests by rubber formula type has been established by the Consortium members which includes existing modified ASTM and ISO standard laboratory methods that can be used for all the screening tests except migration. Multiple methods are mentioned in literature for assessing chemical migration (Lederer *et al.*, 1981).

Antidegradants must pass these screening tests (Table 3.2) as a first step in identifying a possible alternative.

Table 3.2 Potential Laboratory Screening Tests for Requirements by Rubber Compound

Method	Key Parameter	In Rubber Compound Testing		
		Black Sidewall	Tread	Belt Coat
ASTM D1646	Processability (viscosity and scorch)	○	○	○
ASTM D5289-19A/ASTM D2084	Cure, Reversion	○	○	○
ASTM D412-A, ASTM D573	Stress/Strain, Normal and Aged	○	○	○
ASTM D624, ASTM D573	Die C Tear, Normal and Aged	○	○	○
ASTM D2240	Durometer Hardness, Normal and Aged		○	
Lederer RCT	Migration	○	○	○
ASTM D1149	Ozone: Static operation mode	○	○	
	Ozone: Dynamic operation mode	○		
ISO 1431-2012 (11.3)	Ozone: Intermittent Dynamic Exposure, Normal and Aged	○		
ASTM D4482-06	Fatigue to Failure	○		
ASTM D5992-96	Dynamic Properties/Viscoelastic	○	○	○
LAT100/ASTM D5963-04/DIN 53 516	Wear		○	
ASTM D430/ASTM D813	Demattia Fatigue, Normal and Aged		○	
ASTM D2229	Wire Adhesion, Normal and Aged			○
	Green aging			○
	Heat aging			○
	Oxygen aging			○
	Steam aging			○

Notes:

ASTM = American Society for Testing and Materials; ISO = International Organization for Standardization.

3.4.2 Regulatory Requirements for Motor Vehicle Tires

Tires are highly regulated to ensure their safety, quality, and durability. Under the National Traffic and Motor Vehicle Safety Act of 1966 ("Vehicle Safety Act") (US Congress, 1966), automotive vehicles or motor vehicle equipment (including tires) are broadly regulated in terms of potential defects that could

impact motor vehicle safety. The Vehicle Safety Act created the National Highway Traffic Safety Administration ("NHTSA"), which promulgated the Federal Motor Vehicle Safety Standards (FMVSS) as directed by Congress. All passenger, truck and bus, trailer, and motorcycle tires sold in the United States (whether OE or replacement) must meet all applicable FMVSS (49 CFR Part 571). Additionally, passenger car tires sold in the United States must conform to the Uniform Tire Quality Grading Standards (UTQGS) (49 CFR § 575.104).

The Vehicle Safety Act has been amended several times since it was enacted in 1966. Most notably, the Transportation Recall Enhancement, Accountability, and Documentation ("TREAD") Act, enacted in 2000, added several new regulatory requirements for new motor vehicle tires (US Congress, 2000).

Tire manufacturers are required by law to self-certify to the appropriate FMVSS that every tire they manufacture meets safety, durability, and other requirements or regulations prior to sale to the consumer. NHTSA conducts periodic audits of new tires subject to FMVSS to assure compliance. The Safety Act explicitly preempts any state law or regulation that conflicts with a NHTSA regulation relating to "safety." The rationale is that vehicles travel from one state to another and between countries. The absence of a uniform set of safety rules would allow one state to impose arbitrary requirements that could significantly impact interstate commerce.

3.4.2.1 Passenger and light truck tires

Pursuant to the TREAD Act, NHTSA promulgated FMVSS No. 139 (49 CFR § 571.139) in 2003, which established testing requirements for new pneumatic radial tires for light vehicles. FMVSS No. 139 applies to all new pneumatic radial tires for use on motor vehicles made after 1975 with a gross vehicle weight of 10,000 pounds or less, which includes passenger and light truck tires with a tread depth of less than 18/32 of an inch. All tires are required to have dimensions within specific limits and specified markings that notify the consumer of the dimensions of the tire, the maximum load carrying capacity, the tire identification number (TIN), and that the tire is certified to meet the applicable FMVSS. FMVSS No. 139 also imposes requirements for tread wear indicators so consumers can be aware of the need for tire replacement.

FMVSS 139 requires tire manufacturers to meet the following new tire testing requirements:

- **High speed performance:** The high speed test is run on 1.70 m (67") diameter test drums⁸. Tires must complete the 160 km/hr (100 mi/hr) step with no visual evidence of separation in the tread, sidewall, ply, cord, inner liner, belt, or bead; chunking, open splices, cracking or broken cords and the tire pressure when measured within 15-25 minutes after the end of the test cannot be less than 95% of the initial inflation pressure.
- **Endurance:** The endurance test is run on 1.70 m (67") diameter test drums. All tires must complete the endurance portion, plus a 90-minute low inflation pressure step with no visual evidence of tread, sidewall, ply, cord, belt or bead separation, chunking, open splices, cracking, or broken cords, and the tire pressure, when measured within 15-25 minutes after the end of the test cannot be less than 95% of the initial inflation pressure.
- **Bead unseating resistance:** The test requires that tires retain air pressure and beads remain seated on the wheel in a test where an anvil is pressed against the tire sidewall. Wheel, tire inflation pressure, and anvil location are specified by rim diameter and tire type.

⁸ The test drum is a cylindrical structure meant to simulate the road surface. The tire is pressed against the drum and spun to simulate the effect of driving.

- **Tire strength (plunger energy):** The tire strength test requires that tires withstand a slow-moving plunger placed in the center area of the tread to a minimum level of calculated energy.

3.4.2.2 Uniform tire quality grading for passenger car tires

Also pursuant to Section 203 of the Vehicle Safety Act, NHTSA established the -UTQGS as a way to assist the consumer to compare various tires (49 CFR § 575.104). This regulation pertains to passenger car, SUV, and some light truck tires. Tire types excluded from UTQGS are LT-metric light truck tires, winter-type snow tires, low-volume production passenger car tires, motorcycle tires, and tires for truck and bus applications. While the UTQGS specify treadwear, traction, and temperature grades for tires within the scope of this regulation, the threshold values within these tests are informational only and are not directly linked to safety performance of motor vehicle tires.

3.4.2.3 Regulatory Testing Requirements for Truck and Bus Radial Tires and Motorcycle Tires

All new truck and bus radial tires (as well as some light truck tires) and motorcycle tires, are required to meet the following test requirements under FMVSS No. 119:

- **Endurance:** The test tire must complete the full endurance test with no visual evidence of tread, sidewall, ply, cord, belt or bead separation, chunking, open splices, cracking, or broken cords, and the tire pressure at the conclusion of the test cannot be less than the initial inflation pressure.
- **Tire Strength (plunger energy):** The tire strength test requires that tires withstand a slow-moving plunger placed in the center area of the tread to a minimum level of calculated energy.
- **High Speed Performance (applicable only to motorcycle tires and non-speed restricted tires with rim diameter code of 14.5 or less and load range A, B, C, or D):** The test tire must withstand testing at specified load over a series of increasing speeds for a set period of time. The test tire must complete the full test with no visual evidence of tread, sidewall, ply, cord, belt or bead separation, chunking, open splices, cracking, or broken cords, and the tire pressure at the conclusion of the test cannot be less than the initial inflation pressure.

3.4.3 Compliance with and Enforcement of NHTSA Regulations

The Vehicle Safety Act grants broad authority to NHTSA "reduce traffic accidents and deaths and injuries resulting from traffic accidents" by establishing FMVSS (US Congress, 1966). In addition, NHTSA has established regulations that address safety defects in motor vehicles and motor vehicle equipment (including tires) go beyond compliance with FMVSS.

The Vehicle Safety Act establishes a self-certification system for compliance with applicable FMVSS and UTQGS, where it is the responsibility of a manufacturer of vehicles and/or items of motor vehicle equipment, including tires, to certify that each of its regulated products is in full compliance with the performance requirements of all applicable FMVSS and consumer information regulations. This compliance burden is borne solely by the motor vehicle or equipment manufacturer.⁹

⁹ A manufacturer self-certifies a tire meets all applicable federal motor vehicle safety standards by molding "DOT" on the sidewall of the tire in association with the TIN, which identifies the manufacturing plant and date of manufacturer (week and year), among other information.

In addition to assuring that its tires meet all applicable FMVSS, a tire manufacturer designs and manufactures a tire to reduce the risks of a tire containing a safety defect. NHTSA regulations require manufacturers of vehicles and vehicle components to submit information to NHTSA about any FMVSS non-compliances or potential defects (49 CFR § 579).

When a tire manufacturer designs and manufactures a tire, it considers the risk of a potential tire recall. NHTSA maintains broad authority to enforce its regulations by imposing civil and criminal penalties (49 CFR § 578) and by instituting recalls of motor vehicles and motor vehicle equipment that do not meet FMVSS or contain a safety-related defect. Coupled with the NHTSA compliance surveillance program described in the previous section, the NHTSA recall authority creates a strong interest in compliance to all NHTSA requirements due to the potential damage to a company's reputation caused by a significant recall.

3.4.4 Additional Manufacturer Test Criteria for Highway Tires

All tire manufacturers perform a combination of voluntary outdoor vehicle tests, indoor drum tests, and technical tests in addition to all required regulatory tests. In addition to the tests outlined below, tire manufacturers may have their own proprietary test methods based on their specific tire designs and according to their market experiences and needs.

3.4.4.1 Indoor (drum tests) for passenger and light truck tires

Below is a list of typical indoor tests (drum tests) employed in tire development programs. Indoor laboratory tests are typically run on 1.70 m (67") diameter drums that have been an industry standard for decades. Tire manufacturers may have their own proprietary indoor drum test methods based on their specific tire designs and according to their market experiences and needs.

- **High speed performance:** Passenger tires are typically marked with a speed symbol following the maximum load rating. The tire speed symbol indicates the is the highest speed for which a tire is rated. The test method for marking a tire with a specific speed symbol is defined by UN Regulation No. 30. While most tires sold in the US contain speed symbol markings, it is an optional marking in the US from a regulatory perspective. However, most vehicles sold in the US today specify a tire fitment with a minimum tire speed symbol to meet or exceed the speed capability of the vehicle.
- **Endurance:** Tire endurance is a measurement of how long a tire can withstand severe conditions before displaying a condition that indicates the end of the test (damage to the tire). Endurance can be tested by varying the speed, load, inflation pressure, temperature, and/or number of cycles. The most typical tire endurance test varies the load. While FMVSS specifies an endurance test, tire manufacturers also conduct proprietary endurance tests in addition to the regulatory requirements. Some endurance tests are conducted on artificially aged tires, where the tire aging process is accelerated through the use of higher ambient temperatures and ozone and/or oxygen concentrations. These accelerated aging tests are intended to mimic the condition of tires which have been in service, including mileage and environmental exposure.
- **Rolling resistance:** The force necessary to keep a tire rolling is known as rolling resistance. To measure rolling resistance, a load is placed on the tire while it is being forced to turn by the drum and the resistance force which the tire generates to prevent it from turning is measured. In the US, this parameter first became important to vehicle manufacturers in the 1990s with implementation of more stringent Corporate Average Fuel Economy (CAFE) standards for new cars because lower tire rolling resistance equates to greater fuel economy (US DOT, 2006). For

regulatory purposes, rolling resistance is measured according to ISO 28580:2018 and is expressed in terms of rolling resistance coefficient (RRC). Rolling resistance is regulated by UN Regulation No. 117 and other governments globally. Currently, the California Energy Commission is developing a regulatory proposal to regulate rolling resistance in California pursuant to AB 844 (California State Assembly, 2003 Chapter 645).

3.4.4.2 Outdoor (vehicle) tests for passenger and light truck tires

In addition to indoor tests, manufacturers also test tires on actual vehicles to simulate actual (sometimes worst case) driving conditions. To some extent these tests are company specific; each tire manufacturer has proprietary formulas, manufacturing processes, and tire designs and their understanding of their products in the market and how they respond to the variety of environmental and use conditions is unique and must be assessed by each company individually. Below is a list of typical outdoor vehicle performance tests that passenger and light truck tires are subjected to.

- **Wear rate:** Traditionally with an outdoor test, sets of tires are driven at prescribed speeds on a known course to evaluate wear rate, usually measured in miles of travel per thousandth of an inch of tread depth loss (*i.e.*, miles per mil) or as tread loss per mileage increment (*i.e.*, mils/1000 mi).
- **Irregular wear:** During a wear test the tires are assessed for any indications of irregular wear. Uneven or abnormal wear features can significantly shorten the service life or mileage potential of tires.
- **Gravel chip/tear:** For passenger and light truck tires that are intended to be driven off road, an evaluation is conducted on vehicle on a gravel route to assess chipping and tearing of tread elements.
- **Handling – dry, wet, and snow:** Handling is a result of tire/vehicle interactions in response to various driver inputs. Handling evaluations include various road conditions such as dry, wet, and snow but also everyday driving and emergency steering situations.
- **Ride comfort:** A vehicle's perceived ride comfort, whether "sporty" or "plush," can be significantly influenced by tires. The ride comfort is assessed over a variety of road conditions and can include assessment of impacts like potholes and train tracks.
- **Noise:** Tire noise can be generated from the interaction of the tire with the road. Pass-by noise is measured from the sides of the road with a vehicle traveling at a specified speed with the engine not running.
- **Endurance:** Outdoor testing for tire endurance usually involves driving a vehicle on a closed course at a specified level of loads, inflation pressures, and speeds (US DOT, 2006 224-2581).
- **Field Testing:** Tire manufacturers may also conduct field testing to obtain performance data for tires operated under real-life conditions for an extended period of time. This testing is typically performed by a contracted fleet with routine monitoring by the tire manufacturer.
- **Traction:** Dry, and wet: Specially equipped instrumented trailers with computer-controlled braking capability are towed over known skid pad surfaces. Brakes are applied gradually to cause wheel lock-up and peak and slide friction forces are recorded.
- **Snow traction:** Snow testing is conducted as specified by ASTM F1805. Per FMVSS No. 139 (49 CFR § 571.139), to be marked with the Alpine (snow) symbol, a tire must achieve a traction index of 112 or greater as compared to the ASTM F2493 standard reference test tire.

3.4.4.3 Optional technical tests for passenger and light truck tires

In addition to the typical indoor drum and outdoor performance tests, manufacturers also often test finished tires for additional technical properties using specialized equipment, depending on customer requirements and product performance specifications. Some of these tests include the following:

- **Weight:** OE vehicle manufacturers often specify tire weight targets as part of their requirements for meeting CAFE goals since the weight of the tire is directly related to its rolling resistance and fuel efficiency.
- **Force and moment properties:** A tire's cornering capability comes from the forces generated when a tire's direction of motion is different from its heading direction, causing a slip angle. This test is an indication of how the tire will perform on vehicle handling assessments.
- **Electrical resistivity:** Moving vehicles can generate static electricity which is exacerbated by low temperature and humidity.
- **Uniformity:** Due to material and assembly variations that occur during manufacturing and curing, small deviations in tire cross section circumferentially can result in measurable spring rate or dimensional changes, for example, an out-of-round or out of balance condition. This can have an impact on handling, noise, and ride comfort.
- **Air permeation:** Inner liner rubber compounds are formulated to minimize permeation of air through the tire carcass. The air permeation test measures the air loss over a specified time and conditions.
- **Dynamic ozone:** An indoor drum method where the tire is exposed to ozone while it is running on a standard drum at a specified speed, temperature, and ozone concentration. This test can be used to correlate sidewall compound ozone cracking between a variety of market conditions and judge differences in performance of sidewall rubber compounds.
- **Aged tire properties:** ASTM F2838 is a method for inflating tires with a specified oxygen content, pressure, and temperature and placing them in an oven for a specific amount of time to simulate market conditions for the belt coat compound. Once a tire is aged, the belt coat compound can be cut out of the tire and tested to compare the physical properties of the compounds after aging.

3.4.4.4 Additional Manufacturer Test Criteria for Truck and Bus Radial Tires

Tire manufacturers may have their own proprietary test methods based on their specific tire designs according to their market experiences and needs.

- **High speed performance:** Not all truck and bus tires are marked with a speed rating. FMVSS 119 specifies that tires restricted to use at speeds of 55 mph (90 km/hr) or less must be marked to indicate this limitation. For tires which are marked, the tire speed rating is the highest speed that a tire can handle before it does not perform as designed. The test method for marking a tire with a specific speed symbol is defined by UN Regulation No. 54. While many tires sold in the US contain speed category markings, it is an optional marking in the US from a regulatory perspective.
- **Endurance:** Tire endurance is a measurement of how long a tire can withstand severe conditions before reaching its limit. Endurance can be tested by varying the speed, load, inflation pressure,

temperature, and/or number of cycles. The most typical tire endurance test varies the load. While FMVSS specifies an endurance test, tire manufacturers also conduct proprietary endurance tests in addition to the regulatory requirements.

- **Field Testing:** Tire manufacturers may also conduct field testing to obtain performance data for truck and bus tires operated under real-life conditions for an extended period of time. This testing is typically performed by a contracted fleet with routine monitoring by the tire manufacturer.

In addition to the above, truck and bus tires are tested for many of the parameters discussed in Sections 3.4.4.2 and 3.4.4.3.

3.4.5 SmartWay Certification for Truck and Bus Radial Tires

SmartWay[®] Certification is a collaborative effort between the United States Environmental Protection Agency (US EPA) and the freight industry designed to help businesses move goods in the cleanest, most energy-efficiency ways possible while reducing greenhouse gases and air pollution, and protecting public health. SmartWay[®] is a voluntary program outside the state of California; however, within California, the California Air Resources Board (CARB) requires fleets to operate on SmartWay[®] verified tires. The SmartWay[®] program publishes a list of new and retreaded commercial vehicle tires which have been verified to demonstrate a rolling resistance coefficient at or below certain targets set by EPA (US EPA, 2012, 2022).

3.4.6 Summary of Performance Testing Requirements

The paragraphs above outline the extensive set of test requirements that are required for a new tire formulation or design before it can be placed in the market. Starting with laboratory tests as shown in Table 5.14, the successful formulation then passes through several additional stages of testing before finally being tested as manufactured tires on an actual vehicle. Based on the experience of Consortium members, the tire research and development, design, and performance testing process for a tire using existing, commercially-produced materials known to perform as necessary in tires, can take a minimum of 4 to 6.5 years. In the tire design process, each step may be repeated multiple times until an acceptable design is achieved, which can significantly extend the design process. Furthermore, challenges encountered while conducting a step in the tire design process may require development to go back to an earlier stage. In the case of replacing 6PPD, once a new candidate antidegradant is identified, an additional 4 years (minimum) of limited-scale field testing would be required to ensure performance as a tire ages. After satisfactory results are obtained from field testing, additional time will be needed for deployment of the new antidegradant in tires for the market, which could take months to a few years.

3.4.7 Other Regulatory Requirements for the Priority Product

In addition to performance requirements, other regulatory requirements could impact the feasibility or timeline for implementation of any alternative to 6PPD in motor vehicle tires. For example, chemicals that are used in tire manufacturing need to be registered in the various jurisdiction where tires are manufactured (*e.g.*, the US, the European Union, China, South Korea). Whether or not a possible alternative is already listed on the various chemical inventories could be a significant factor in terms of the timeline for implementing an alternative. In addition, given the volumes of antidegradant that will be required for global tire production, even chemicals already present on chemical inventories may be shifted to higher production volume categories, which could trigger additional data submission requirements in terms of chemical,

environmental and toxicological properties. In particular, the need for additional toxicity testing, particularly for carcinogenicity or reproductive toxicity, could add significantly to the cost and timing of implementing any alternative (*e.g.*, a standard carcinogenicity study can take up to four years to complete). Another potential regulatory requirement is California's Proposition 65, which will become significant if any possible alternative is listed by the State of California as known to cause cancer or reproductive harm. Some of the possible alternatives also have use restrictions in the US. For example, some carbon nanotubes and graphene have Significant New Use Restrictions under the Toxic Substance Control Act (TSCA) (US EPA, 2023a), which means additional regulatory obligations would need to be considered if either were to be used in tires. The State of Washington also has announced "6PPD Alternatives Assessment Hazard Criteria," which differ from those required by the SCP regulations. The SCP regulations do not require consideration of criteria established by other states in searching for an alternative. From a practical implementation standpoint, the Washington criteria could be considered, among other factors, in the Stage 2 AA when selecting final recommended alternatives.¹⁰

3.5 Necessity of the Function of the Chemical of Concern in the Priority Product

Under CCR §69505.5 3(A), responsible entities, in this case, Consortium members, are required to determine whether the chemical of concern or an equivalent replacement is necessary in order to meet the product's functional and legal requirements or whether the chemical of concern can simply be eliminated from the product without replacement. As discussed in prior sections, all tires require antidegradants, including antioxidants and antiozonants, for safe performance. Thus, simply removing the chemical of concern, 6PPD, from motor vehicle tires without replacement is not an option.

¹⁰ We also note that the Washington hazard criteria are essentially guidelines for use in the evaluation of alternatives and not standards for compliance (*e.g.*, like US EPA water quality criteria).

4 Scoping, Identification of Possible Alternatives and Relevant Factors

4.1 Purpose and Approach for this Stage 1 AA

As conceived by Gradient and the Consortium, the goal of a preliminary (Stage 1) AA under the SCP program is to answer the following question: Do potentially safer, functionally acceptable, and technically feasible alternatives to the Priority Product exist that should be given a more in-depth consideration to determine if they qualify as acceptable alternatives? If the answer to this question is yes, then a 2nd Stage AA is appropriate, where factors such as economic feasibility are considered. If the answer is no, then an Abridged AA is required. The aim of Stage 1 is not to definitively identify a final alternative but rather to identify apparently acceptable candidate alternatives for further study. We believe this philosophy is in accord with the SCP regulations (CalDTSC, 2013a).

4.2 Alternatives Under the SCP Regulation

The SCP AA process requires responsible entities to identify and consider alternatives to 6PPD that meet the definition of "alternative" under section 69501.1 and potentially meet the Priority Product's requirements as outlined in section 3 of this AA (CalDTSC, 2013b SCPR section 69505.5(b)). To create the list of candidate alternatives, the Safer Consumer Products regulation requires responsible entities to "evaluate available information that identifies existing possibly viable alternatives for consideration in the AA" (CalDTSC, 2013b SCPR section 69505.5(b)).

An alternative may include any of the following:

- Removal of a Chemical of Concern from a Priority Product, with or without the use of one or more replacement chemicals.
- Reformulation or redesign of a Priority Product and/or manufacturing process to eliminate or reduce the concentration of a Chemical of Concern in the Priority Product.
- Redesign of a Priority Product and/or manufacturing process to reduce or restrict potential exposures to a Chemical of Concern in the Priority Product.
- Any other change to a Priority Product or a manufacturing process that reduces the potential adverse impacts or potential exposures associated with the Chemical of Concern in the Priority Product, or the potential adverse waste and end-of-life effects associated with the Priority Product that also meets the Priority Products function.

4.3 Inclusion of Performance as a Consideration in the Stage 1 AA

The SCP regulations do not list performance as a required consideration (*i.e.*, relevant factors) for a Stage 1 AA but rather include it as a required consideration for Stage 2. However, the SCP regulations (§ 69505.5 (e)) permit for the Consortium to include additional factors that they deem relevant to the AA at their

discretion (CalDTSC, 2013a). The Consortium maintains that performance is a critical element of an AA at the initial stage because an alternative that has unacceptable performance (*i.e.*, performs poorly compared to the current product by a reasonable metric related to consumer safety or expectations) may impact tire safety, longevity, or health or environmental impacts, and will not be a viable alternative and should therefore not be considered further. Thus, performance is included as a relevant factor in this Stage 1 AA report.

4.4 Scoping: Alternatives Outside the Scope of This AA Report

The first element of an AA involves scoping, or determining the range of alternatives that will and will not be considered in the AA. Certain alternatives are being excluded from further analysis because they are too preliminary in their stage of development to meet the likely implementation schedule under the SCP regulation. These alternatives also have very limited data with which they can be evaluated and would require a revision of federal safety regulations which is something beyond the scope of the SCP program. Some alternatives also likely pose the same issues as current tires (*i.e.*, by using rubber tread) and so would not constitute an alternative with a different hazard profile. Three possible technologies are not being considered as part of this AA: 1) non-pneumatic tires, including Shape Memory Alloy Radial Technology (SMART) tires; 2) electrostatic particle collectors; and 3) modified EPDM or halobutyl elastomers.

4.4.1 Non-Pneumatic Tires

As mentioned in the DTSC Technical Report, some companies are working towards non-pneumatic, or airless motor vehicle tires. These transmit the vertical load and tractive forces from the roadway to the vehicle and generate the tractive forces that provide the directional control of the vehicle without the containment of any gas or fluid for providing these functions. Examples of prototype non-pneumatic tires are shown below (Figure 4.1).



Figure 4.1 Examples of Non Pneumatic Tire Products. Sources (left to right): Michelin, 2023; Bridgestone Corp., 2013; Goodyear, 2023.

As of early 2024, there are no commercially available non-pneumatic motor vehicle tires being sold in the United States, and the FMVSS currently require all new motor vehicles to be equipped with pneumatic tires. Market introduction of a non-pneumatic tire is expected within the next several years, but the FMVSS and multiple state laws would need to be amended before this can occur. Widespread adoption of non-pneumatic tires over a broad range of tire sizes, load capacities, and speed ratings is anticipated to be at least several additional years into the future. Non-pneumatic tires are incompatible with many of the current industrial processes utilized by the tire industry. Significant investment, potentially including new production facilities, will likely be required to mass-produce these types of tires.

Non-pneumatic tires for off-road applications such as agricultural equipment, construction equipment, and utility terrain vehicles (UTVs) are commercially available; however, tires for these applications are designed for significantly different operating conditions than motor vehicle tires (*e.g.*, lower speeds) and are not subject to FMVSS, as NHTSA's authority only extends to vehicles and vehicle components for on-highway use.

Although non-pneumatic tires rely on a different mechanism to support a vehicle load *versus* conventional motor vehicle tires, many of the components in non-pneumatic tires, including the tread, are composed of rubber compounds that contain 6PPD to protect the compounds from environmental degradation and fatigue. Accordingly, 6PPD would still be present in non-pneumatic tires. Also, due to the tread compounds used, treadwear rates of any future non-pneumatic tires may not be significantly different than conventional pneumatic tires of the same size, load capacity, and speed rating. While the total amount of 6PPD in such tires may be reduced (due to the lack of a sidewall), 6PPD would still be present in the portion of the product contacting the roadway. It is also unclear whether the concentration of 6PPD in the tread rubber would have to be different (*e.g.*, higher) in these tires to compensate for the reduced reservoir created by a lack of sidewall.

The DTSC report mentions nickel-titanium spring tires from the SMART Tire company as a possible alternative. The SMART tire is another concept for a non-pneumatic tire. At this time, the tire is not in production (the company website suggests it would be available for bicycle tires in 2023 but no other information is given) and the manufacturer indicates they are looking for investors. The company website indicates that the product for vehicle applications will contain a rubber tread compound, so it is not known if it will contain 6PPD. As with the other non-pneumatic tires discussed above, the concentration of 6PPD in the tread is not known.

Due to the unknown timing of widespread availability for motor vehicle use and their current materials of construction, non-pneumatic, or airless tires, are deemed to be outside the scope for this report.

4.4.2 Electrostatic Particle Collectors

Tyre Collective is a company that is working on an electrostatic collection device for TRWP (The Tyre Collective Ltd., 2024). This device is placed behind the tire on the vehicle and is not an innovation that can be applied to a tire. This technology is in the proof-of-concept phase and the most recent trial showed a 20% collection efficiency by mass. A 20% reduction in TRWP release may not be sufficient to meet the SCP requirement of a "material difference". It could also impose an additional burden on consumers if the collector has to be replaced or emptied periodically in a repair shop to function. The tire industry also has no authority to require additional products beyond tires to be installed on new vehicles or retrofitted to existing vehicles. This would be the choice and responsibility of vehicle manufacturers, who are not subject to the AA requirement. It is unknown if such a device would impact aerodynamics, fuel efficiency or vehicle clearance. Therefore, electrostatic particle collectors are also deemed to be outside the scope of this report.

4.4.3 Modified EPDM or halobutyl rubber to reduce 6PPD concentrations in sidewall

Consortium members also identified several approaches for reducing the concentration of 6PPD in tires, which constitute a potentially viable approach under the SCP regulations. The alternatives involve using (1) a modified EPDM to formulate the sidewall rubber (two approaches) or (2) bromobutyl rubber to formulate the tread. Both EPDM and bromobutyl rubber are inherently resistant to ozone attack. While these materials normally cannot be used in tire sidewall and tread due to chemical incompatibility (*e.g.*, bromobutyl rubber is used exclusively in the inner liner), the Consortium did discover patents which

describe ways to use these elastomers (with modifications) to formulate sidewall (EPDM) and tread (bromobutyl) rubber.

There are two reported EPDM applications. The first involves EPDM modified with N-chlorothiosulfonamides (Hopper, 1976). In this case, the structure of the EPDM has been modified to put a chlorine atom along the backbone of the EPDM, which is subject to thermal degradation to produce hydrochloric acid (HCl). It is well known that chlorinated polymers can undergo thermal degradation to produce HCl (Krongauz *et al.*, 2011). Tire manufacturers avoid introducing chlorinated materials into the production process because HCl is known to corrode production equipment and would also likely require changes to air emissions permits if chlorinated compounds are being generated. Further, this application is only relevant for replacing 6PPD in sidewalls and thus would not affect the composition of tread material, which is the source of TRWP. The extent to which the tire sidewall contributes to the potential migration of 6PPD from tires into the environment (*via* blooming and washing off rather than from TRWP) is unknown and unquantified. Loss of 6PPD/6PPDQ from tread will occur predominantly while the vehicle is moving (by generation of TRWP), whereas sidewall loss of 6PPD/6PPDQ (by being washed off the sidewall) would occur predominantly during the parked stage of vehicle use (since, at least for passenger vehicles, the vast majority of time is spent parked). Since 6PPD will still be used in other parts of the tire, the potential benefit of this alternative is unclear. The Consortium is aware of one patent that considered the potential use of modified EPDM in tread (Sandstrom, 1992), but this still required the use of antidegradants such as 6PPD.

The second EPDM approach for sidewalls involves blends of conventional EPDM and natural rubber in an attempt to make ozone resistant sidewalls (Tinker and Jones, 1998). A special mixing protocol was required and mixing conditions were specified to maximize the probability of success. Despite these enhancements, the tires experienced structural failures during product testing. In addition, the mixing protocol used by the authors could not be effectively used in a tire plant because of "rework" issues. "Rework" is a recycling process where scrap material from processing operations is put back into fresh mixes of rubber. Because this study required the use of virgin ingredients, rework was not possible (to determine the effect of rework on a compound, a great deal of mixing is required so that the final levels of added material becomes stabilized). The potential for rework is critical because it involves a substantial amount of compound, and elimination of the use of rework would generate substantial production waste, require higher volumes of raw ingredients, with associated lifecycle impacts, and make tires uneconomical to consumers. In addition, as noted above, this approach is only relevant to sidewalls which would not address concerns with 6PPD in TRWP.

The bromobutyl rubber patent describes a formulation requiring an organosilane cross linking agent and "effective amounts of processing aids" whose nature is not stated. Like EPDM, the use of bromobutyl rubber would also significantly impact the possibility of rework, potentially creating more waste material. For use of bromobutyl rubber in tread, although the ozone resistance of the bromobutyl rubber is mentioned, antioxidants and antiozonants are still included as ingredients in the patents so the degree of 6PPD reduction is not clear. In addition, if other rubber (requiring 6PPD) is used for the sidewall and other tire components, the 6PPD in the rest of the tire could still migrate to the tread and be put into the environment *via* TRWP. Finally, it is commonly known that butyl elastomers have very high hysteresis relative to natural rubber, polybutadiene and SBR elastomers. This high hysteresis would result in higher operating temperatures as well as higher rolling resistance, which could result in failure to meet tire endurance performance requirements specified in US FMVSS 119 and 139. In addition, higher hysteresis results in lower fuel mileage for internal combustion engines and reduced range for electric vehicles..

Thus, because the potential benefit appears questionable and there are many unknowns regarding the feasibility of implementation, these options are not evaluated further in the AA.

4.4.4 Waxes and Coatings

As mentioned in the DTSC Product-Chemical Profile (CalDTSC, 2022), waxes and coatings could provide a physical barrier to prevent ozone attack. However, this approach only works under static conditions (*i.e.*, when tires are not in motion) and "face significant challenges under dynamic conditions – that is, during a tire's intended use on a motor vehicle" (CalDTSC, 2022).

Blends of microcrystalline and paraffin waxes are currently used as processing aids in production of tire rubber to provide lubrication, mold release, and improve ozone resistance (Akrochem, 2002). However, waxes are always used in combination with 6PPD in tires. When used alone, waxes can only protect tires from ozone under static conditions. While cars are in motion (*i.e.*, dynamic condition), the wax film breaks, exposes the underlying rubber to ozone attack, and causes earlier failure (Akrochem, 2002). Similarly, coatings wear off while cars are in motion and prematurely expose the underlying rubber to ozone attack. DTSC's Product-Chemical Profile (CalDTSC, 2022) noted that waxes and coatings are "likely infeasible means of protecting the tire tread." Because sidewalls also flex during movement and can experience scuffing and other environmental damage, coatings and waxes are also not a good solution for protecting non-tread parts of the tire from ozone.

4.5 Possible Alternatives to 6PPD in Motor Vehicle Tires

4.5.1 Approach for Identification of Alternatives

Once the scope of the AA has been identified, the next critical step is to gather information on possible alternatives. To conduct an informative AA, one needs to consider not only those products made by the Consortium members but also other products that are available as these may be possible alternatives. As required under the SCP regulation, the Consortium must consider any candidate alternatives that are posted on the Department's website (CalDTSC, 2024). DTSC indicates that additional information sources which should be considered are journals, articles, books, references, handbooks, encyclopedias, patents, and internal company files. To identify possible alternatives, the Consortium conducted literature searches, surveyed members for literature sources, and surveyed expert industry consultants for additional literature sources. The following literature sources were evaluated by the Consortium to identify candidate alternatives:

- Technical journals, including, but not limited to
 - Rubber Division of the American Chemical Society – Rubber Chemistry and Technology
 - Rubber World
- Trade media, including, but not limited to
 - Tire Business
 - Rubber and Plastics News
 - Tire Review
 - International Tire Technology Magazine
- Reference literature and books, including, but not limited to
 - "Ozonation of Organic and Polymer Compounds" by Gennady E. Zaikov and Slavcho K. Rakovsky
 - "Ozone Risk Communication and Management" by Edward Calabrese, Charles Gilbert, and Barbara Beck
 - Vanderbilt Rubber Handbook, 14th edition

- "Blends of Natural Rubber: Novel Techniques for blending with Specialty Polymers," edited by A. J. Tinker and K. P. Jones, Chapman & Hall, London, 1998.
- Rubber Compounding Chemistry and Applications, 2nd Ed., Brendon Rogers, CRC Press, 2016 p. 419-459
- Online reference material, including, but not limited to
 - PubChem
 - Chemical supplier websites
- Government materials, including, but not limited to
 - Chemical Profile for Motor Vehicle Tires Containing N-(1,3-Dimethylbutyl)-N'-phenyl-p-phenylenediamine (6PPD) (CalDTSC, 2022)
 - Washington Department of Ecology Technical Memo (WA Ecology, 2021)
- Patent searches, including, but not limited to
 - United States Patent and Trademark Office (USPTO)
 - Google patents
- Consultation with university and government researchers, including but not limited to
 - University of California, Berkley
 - University of Washington
 - Washington State University
 - University of Massachusetts-Lowell
 - US Geological Survey (USGS)

In addition, USTMA prepared a survey concerning knowledge of research on alternatives that was sent to all Consortium members. The survey asked questions about alternatives currently under investigation as well as alternative antidegradants that had been evaluated in the past and found unsatisfactory. It also asked about company awareness of research or ideas being put forth by other entities. Responses to the survey were aggregated *via* a third party law firm to ensure confidentiality. A copy of the survey is included as Appendix D.

Over 70 possible alternative antiozonants were identified through this process (see Appendix F). The identified chemicals were screened for compound effectiveness against ozone. Once the information was collected, the chemicals were tabulated along with their related scientific information from the literature review in a spreadsheet and scored as to their perceived feasibility to function as an antiozonant in tires. The following scoring system was used:

Compound Effectiveness Against Ozone:

- 1 = There is existing ozone data that indicate the chemical does not work in tire rubber
- 2 = Feasibility data are lacking but the chemical structure indicates is it unlikely to work in tires as an antiozonant
- 3 = Feasibility data are lacking but the chemical structure is promising as an antiozonant
- 4 = There are some positive ozone data indicating effective performance in tires but data are limited

Based on this scoring approach, chemicals with compound effectiveness against ozone scores of 3 or 4 in Appendix F were evaluated further in this preliminary (Stage 1) AA. However, all possible alternatives suggested by DTSC in the Priority Product profile (CalDTSC, 2022) and all possible alternatives listed on DTSC's website (CalDTSC, 2024), including but not limited to those possible alternatives suggested by the Washington State Department of Ecology (WA Ecology, 2021) were retained for this Preliminary AA, irrespective of their scores for effectiveness against ozone. Although the search was broad enough to include combinations of antidegradants that could be used to replace 6PPD, relatively few antidegradant mixtures were identified. This is likely because investigating binary or greater mixtures of antidegradants

introduces a high degree of complexity into testing (*i.e.*, requiring tests of multiple concentration combinations).

Overall, a total of 43¹¹ possible alternatives were evaluated further in this Stage 1 AA. A number of the possible alternatives suggested by DTSC or references cited by DTSC (*e.g.*, modified EPDM, non-pneumatic tires, coating, wax) are discussed in more detail in Section 4.4, but not evaluated further for hazard, exposure, and performance in this Stage 1 AA.

4.5.2 Possible Alternatives Identified

4.5.2.1 Possible Alternative PPDs

Based on the review process outlined above, the Consortium identified 19 potential 6PPD analogs that could potentially serve as substitutes for 6PPD. Note that these are not demonstrated to be actual alternatives to 6PPD but rather are chemicals that merit evaluation as shown in the AA to see if there is sufficient information indicating they could be possible alternatives to 6PPD. The order of the chemicals listed in Table 4.1 below does not indicate a relative level of priority.

Table 4.1 Possible PPD Derived Alternatives Meriting Further Study in Stage 1 AA

Chemical Name	Acronym	CAS
N-(1,4-Dimethylpentyl)-N'-phenyl-p-phenylenediamine	7PPD	3081-01-4
N-Isopropyl-N'-phenyl-p-phenylenediamine	IPPD	101-72-4
N-Cyclohexyl-N'-phenyl-p-phenylenediamine	CPPD	101-87-1
N,N'-Diphenyl-p-phenylenediamine	DPPD	74-31-7
N,N'-Bis(1,4-dimethylpentyl)-p-phenylenediamine	77PD	3081-14-9
4,4'-Dioctyldiphenylamine	DOPD	101-67-7
N,N'-Ditolyl-p-phenylenediamine	Commercial DTPD	68953-84-4
N,N'-Dicyclohexyl-p-phenylenediamine	CCPD	4175-38-6
Diaryl-p-phenylene diamine	DAPD	68953-84-4
N,N'-Di-2-naphthyl-p-phenylenediamine	DNPDA	93-46-9
N'-Phenyl-N-Fluorenyl-Para-Phenylenediamine	NA	No CAS
N-(p-Phenylthiomethylphenyl)-N'-(1,3-dimethylbutyl)-p-phenylenediamine	NA	No CAS
4-(2,5-Dimethyl-1H-pyrrol-1-yl)-N-phenylaniline	NA	No CAS
N,N - (Ethane-1,2-diyl) bis (N-phenylbenzene-1 4-diamine or similar chemical 1-N-[2-(4-anilinoanilino)ethyl]-4-N-phenylbenzene-1,4-diamine	NA	No CAS
4-N-(2,3-Dimethylphenyl)-1-N-phenylbenzene-1,4-diamine- R1 and R2 are methyl	NA	No CAS
RU997, Irgazone 997 Reaction product of N-phenyl-N'-(1,3-dimethylbutyl)-p- phenylenediamine with an alkyl glycidylthioether	NA	No CAS
4-[4-(4-Methylpentan-2-ylamino)anilino]phenol	NA	No CAS
Representative example from class (4-((4- (dimethylamino)phenyl)amino)phenol)	NA	6358-22-1
N-1-Methylheptyl-N'-phenyl-p-phenylenediamine	8PPD or UOP 688	15233-47-3

Notes:

CAS = Chemical Abstracts Service Number; NA = Not Available; PPD = Paraphenylene Diamine.

¹¹ While waxes and coatings were carried from Appendix F into the Stage 1 AA because they were suggested by DTSC, they were not evaluated further for hazards, exposure, and performance because they are non-viable alternatives when tires are in motion. Thus, they did not contribute to the count of possible alternatives evaluated in this Stage 1 AA. See Section 4.4 for more discussions on wax and coating.

Among these are PPDs that have been discussed in various documents as possible 6PPD replacements (*e.g.*, 7PPD, IPPD, 77PD, CPPD) and which are used to some extent commercially. The list also contains less well-known analogs, many of which lack CAS registry numbers. Lacking CAS numbers makes identifying toxicological or chemical data for these analogs challenging because all can be described by various chemicals names.

4.5.2.2 Possible non-PPD chemical alternatives

The Consortium's search process also identified 24 non-PPD possible alternatives as shown below (Table 4.2). Again, these are not demonstrated to be alternatives to 6PPD but rather are chemicals that merit evaluation in the AA to see if there is sufficient information indicating they could be potential alternatives to 6PPD. The order of the chemicals listed below does not indicate a relative level of priority.

Table 4.2 Possible Non-PPD Alternatives Meriting Further Study in Stage 1 AA

Chemical Name	Acronym	CAS
N-1,3-Dimethylbutyl-N'-phenyl quinone diimine	6QDI	52870-46-9
Polymerized 2,2,4-trimethyl-1,2-dihydroquinoline	TMQ Oligomer	26780-96-1
Nickel dibutyldithiocarbamate	NBC	13927-77-0
Ethoxyquin	NA	91-53-2
Dilauryl thiodipropionate	NA	123-28-4
N,N-Diethyl-2,2,4-trimethyl-1H-quinolin-6-amine (R= N(C ₂ H ₅) ₂)	NA	No CAS
Mixed xylene diamines N,N'-Dibenzyl-p-xylene-alpha,alpha'-diamine-	NA	25790-41-4
2,4,6-tris-(N-1,4-Dimethylpentyl-para-phenylenediamino)-1,3,5-triazine	TAPDT	121246-28-4
N-Phenyl-1-naphthylamine	NA	90-30-2
N-Phenyl-2-naphthylamine	NA	135-88-6
[2-Methyl-4,6-bis((octylthio)methyl)phenol (Irganox 1520) ¹	NA	110553-27-0
Specialized graphene ²	NA	1034343-98-0
1,1'-Pentamethylenebis(2,2-di-n butylhydrazine)	NA	No CAS
α-C-4-Hydroxy-3,5-dimethylphenyl-N-isopropyl combined with 2,2'-Methylenebis[6-(1-methylcyclohexyl)-p-cresol]	NA	77-62-3
N-(4-Methylpentan-2-yl)-10H-phenothiazin-3-amine	NA	No CAS
7-(4-Methylpentan-2-ylamino)-2,3,4,10-tetrahydro-1H-acridin-9-one	NA	No CAS
2-Cyclohexyl-N-(4-methylpentan-2-yl)-1H-indol-5-amine	NA	No CAS
4-(1H-Indol-2-yl)-N-(4-methylpentan-2-yl)aniline	NA	No CAS
α-C-4-Hydroxy-3,5-dimethylphenyl-N-tert. butyl nitron	NA	No CAS
Amine functionalized lignin	NA	No CAS
Rambutan peel extract	NA	No CAS
Octyl gallate ³	NA	1034-01-1
Nano calcium carbonate surface modified by gallic acid	NA	No CAS
Specialized carbon nanotube mixture ⁴	NA	No CAS

Notes:

6QDI = N-1,3-dimethylbutyl-N'-phenyl quinone diimine; AA = Alternative Analysis; CAS = Chemical Abstracts Service Number; NA = Not Available; NBC = Nickel dibutyldithiocarbamate; PPD = Paraphenylene Diamine; TAPDT = 2,4,6-tris-(N-1,4-dimethylpentyl-para-phenylenediamino)-1,3,5 triazine; TMQ = Poly(1,2-dihydro-2,2,4-trimethyl-quinoline).

(1) A potential alternative is Irganox 1520 CAS 110553-27-0 blended with Vulcazon AFS. However, according to the source patent (Dall'Abaco *et al.*, 2018), the best ratio is where 100% of the blend is Irganox 1520. Additionally, no hazard data were located for Vulcazon AFS. Thus, only Irganox 1520 CAS 110553-27-0 was evaluated further in this AA.

(2) The materials referred to as graphene in this report are graphene-based materials (sometimes referred to as a graphene nano-platelet) with a surface area not greater than 180 m²/g, and a carbon content greater than 99% and an oxygen content less than 1%. The lateral particle size of these materials is between 100 nm and 5 μm.

(3) Octyl gallate was investigated instead of propyl, butyl or pentyl gallates. Propyl gallate has been tested as an antiozonant for non-rubber applications. Propyl gallate, however, is expected to be less suitable for rubber than other gallate esters with longer carbon chains. Propyl gallate melts at 150°C, which is the temperature at which rubber is mixed. Natural rubber compounds are sometimes mixed at a lower temperature. Unless propyl gallate completely melts and is dispersed in the compound, it will not have an opportunity to function as an antiozonant. Octyl gallate is a much better choice for this analysis because it melts at approximately 100°C and is sure to melt during mixing. Butyl gallate melts at 144°C so it may be acceptable, but octyl gallate has been used as a food additive, is more readily available and has more hazard information.

(4) An example of specialized carbon nanotube mixture is MOLECULAR REBAR[®] carbon nanotubes. The composition of MOLECULAR REBAR[®] carbon nanotubes is not known to the consortium members. However, according to a patent by Molecular Rebar Design on mixtures of discrete carbon nanotubes (Peddini, 2021), the mixture is a dried liquid concentrate of carbon nanotubes and various rubber processing oils (*i.e.*, tris (2-ethylhexyl) trimellitate oil, TP-95, HyPrene 100 naphthenic oil, castor oil, carnauba wax, curing co-agents, and/or sebacates), in which carbon nanotubes may make up anywhere from 5 to 50% of the dried liquid concentrate. Additionally, according to a 2016 SDS from Molecular Rebar Design on MR 1420X DLC (naphthenic oil-MR dry liquid concentrate), this product is 15-20% of functionalized multiwalled carbon nanotubes (CAS # not yet assigned) and 75-85% of naphthenic oil CAS # 64742-52-5 (Molecular Rebar Design, 2015).

Notably these include a number of possible alternatives (*e.g.*, ethoxyquin, dilauryl thiodipropionate) that likely cannot replicate the functions of 6PPD but were included in the list because they were identified by DTSC or Washington Ecology as possible alternatives. As with the possible PPD alternatives, a number of these chemicals also lack CAS registry numbers making it difficult to identify potential toxicity and chemistry data.

4.6 Relevant Factors

According to the SCP regulations, each alternative must be reviewed to determine whether its use would lead to a material difference relative to the existing chemical (here 6PPD) in the various relevant factors listed in the regulation. We have considered the possibly relevant factors listed in Tables 3-1A and 3-2B of the DTSC AA Guide (2017) (which are consistent with those listed in the SCP regulation, § 69505.5 (c) (CalDTSC, 2013a)). Our review occurred in stages. For some factors (*e.g.*, molecular weight) it was readily apparent that these would not be material differentiators among the different products under review. For others (notably the various toxicities specified in the SCP regulation [CalDTSC, 2013a]), we had to first tabulate data for the possible alternatives to understand if these factors differed materially among the products (the results of the tabulation are discussed in Section 5). Based on our current knowledge of the properties of the different alternatives we have identified, we have determined which factors make a material difference among the priority product and any possible alternatives such that it would inform the decision of the Stage 1 AA. The conclusions we have reached are provided in Table 4.4.

4.6.1 Information on Sales of the Priority Product in California

The SCP regulations require that product sales information be included in the AA. As indicated in Table 4.3 below, an estimated 33,332,000 passenger car/light duty truck tires were shipped to California in 2022 and an estimated 3,160,000 heavy duty truck and bus tires were shipped to California in that year, for an estimated total number of tires shipped to California in 2022 at 36,492,000 units. Further details regarding the derivation of this number are provided in Appendix E.

Table 4.3 Estimated Annual Shipments of the Priority Product in California

Vehicle Category	USTMA Tire Shipments in 2022	
	U.S.	CA (est.)
Passenger/Light Duty Truck	298,847,000	33,332,000
Heavy Duty Truck/Bus	33,139,000	3,160,000
Total	331,986,000	36,492,000

Notes:

CA = California; est. = Estimated; U.S. = United States.

4.6.2 Relevant Exposure Pathways

We have considered the exposure pathway-related factors listed in Table 3-2C of the DTSC AA Guide (2017) (which are consistent with those listed in the SCP regulation, § 69505.5 (c) (3)) (CalDTSC, 2013a). Based on our current knowledge of the properties of the different possible alternatives we have identified, we have determined which exposure pathway-related factors make a material difference among the priority product and any possible alternatives. The conclusions we have reached are described in Table 4.5.

4.6.3 Conceptual Model for Product Life Cycle

Figures 4.2 and 4.3 show the conceptual exposure models for the life cycle of the Priority Products (*i.e.*, 6PPD-containing tires), and the potential non-6PPD-based tires, respectively. Both types of products are assumed to have the same life cycle stages, although end of life process may vary depending on the alternative.

Across the various life cycle stages (*e.g.*, raw materials extraction, manufacturing, distribution, use, disposal) of the Priority Products, exposure to 6PPD (or its possible alternatives) for raw material production workers, tire manufacturing workers, consumers, or the general public *via* the inhalation and/or dermal contact exposure routes is possible. For the chemical production and tire manufacturing workers, the main routes of concern are inhalation and dermal, although engineering controls and PPEs are used for some chemical production and tire manufacturing activities. For both new and retreaded tires, there is potential exposure (inhalation mostly) during tire buffing and retread casing preparation, however, engineering controls are in place for workers.

During the use phase of the life cycle, there are some emerging exposure pathways relating potential inhalation exposures to airborne TRWP for the general public (Cao *et al.*, 2022; Johannessen *et al.*, 2022). More data are needed in order to confirm these findings.

With respect to fish consumption, existing studies have reported the presence of 6PPDQ or 6PPDQ metabolite only in parts of fish that are not commonly consumed such as the brain (Hiki *et al.*, 2022 223-10360; Liao *et al.*, 2024 224-6089), bile (Montgomery *et al.*, 2023 224-6594), and gills (Hiki *et al.*, 2022 223-10360). Data are unavailable to assess the presence of 6PPDQ in other parts of fish that are more commonly consumed (*e.g.*, muscle) and if there are species related differences in 6PPDQ uptake.

In California, the current industry metrics for end-of-life tire processing estimate that 45%, 16%, and 35% of end-of-life tires enter into landfills, tire derived fuel, and recycling (*e.g.*, retreaded as tires for buses and

heavy-duty trucks, crumb rubber), respectively, in 2021 (CalRecycle, 2023). As for environmental exposures relating to the end-of-life processing of 6PPD-containing tires, more data are needed in order to assess potential concerns because migration of 6PPD, and the degradation product 6PPDQ, from recycled tires in products such as crumb rubber is not well characterized.

End of life processes are not known for possible alternatives to 6PPD. It is possible that motor vehicle tires containing possible alternative(s) to 6PPD will have similar end of life processes like landfill, reuse, crumb rubber, *etc.*

4.7 Life Cycle Segments

Consistent with the requirements of the Stage 1 AA, we approached life cycle considerations from the perspective of what is readily known or understood about the possible alternatives without engaging in extensive analysis. The Stage 2 AA would involve a more detailed effort at substantiating and potentially quantifying life cycle differences among the different products under review. The information presented below is intended to be complimentary to the life cycle information provided in Tables 4.4 and 4.5. We note that several life cycle assessments (LCAs) have been developed for tires (BLIC, 2001; Piotrowska *et al.*, 2019; Dong *et al.*, 2021; Michelin, 2021); however, none of these are granular enough to discuss the life cycle impacts of using 6PPD in tires. Thus, these LCAs provide very limited information for evaluating the life cycle impacts of tires containing 6PPD *versus* those that contain a possible alternative.

4.7.1 Raw Materials Extraction

To better understand the impacts of 6PPD and the possible alternatives, we compiled information on chemical production for the 6PPD and the other alternatives by consulting the National Library of Medicines PubChem database, which provides data on chemical manufacturing processes including the raw ingredients (Table 4.6). We used the database to sequentially trace back the processes and ingredients used to produce 6PPD and the possible alternatives until we reached an apparent starting material (*e.g.*, simple hydrocarbons that are extracted from fossil fuels or mineral salts obtained from mining). Information was available for most but not all possible alternatives; for some specific PPDs information was lacking but could be inferred from information provided for other members of this family. Based on our review, it is expected that 6PPD and most of its possible alternatives will ultimately be produced from fossil fuel sources or from mining activities (*e.g.*, metal catalysts, sulfur). Carbon nanotubes are primarily produced by vapor deposition using carbon rich gases (*i.e.*, methane or ethylene) obtained from fossil fuels, although use of carbon dioxide (*e.g.*, from carbon capture) is a possible although not widespread technology. Commercially available graphene products are produced by chemical treatment of mined graphite. Octyl gallate can be obtained from plant sources although it is likely that chemical synthesis will be required to meet demand. Both amine functionalized lignin and rambutan peel extract involve agriculturally produced materials. It is unclear whether current agricultural production of these materials is sufficient to support the antioxidant/antiozonant needs of tire production, especially for rambutan peel extract. If the active ingredients in rambutan peel extract are produced synthetically, they may well involve fossil fuel precursors.

While information on raw materials extraction is limited, we believe it indicates it is unlikely that there will be material differences among the possible alternatives, as all involve inputs involving fossil fuels and/or mined materials of various types (*e.g.*, metals). All of the alternatives will have a potential for worker exposure during the raw materials extraction phase; the extent and potential hazards of the exposure could differ but is unlikely to be materially relevant for those involving fossil fuel sources. For other possible alternatives, there is uncertainty whether chemical synthesis from fossil fuel precursors will be required to

meet demand, if chemical synthesis is required, then exposure potential during this life cycle stage will likely be the same. Thus, the overall impact on raw materials extraction is unlikely to be materially different for any of the possible alternatives under consideration based on information that is currently available.

4.7.2 Resource Inputs and Other Resource Consumption

This aspect of the life cycle describes raw ingredients and energy required to produce the antidegradant as well as other materials that might be impacted by the production processes (*e.g.*, water used for cooling). This information would likely be found in LCAs and those available for tires do quantify resource inputs (water, energy) for tire manufacturing. However, as noted above, there is no LCA available that quantifies the aspects of the life cycle specific to 6PPD and thus quantitative comparisons to the impacts of the possible alternatives is not feasible. None of the alternatives under consideration would require a wholesale change in the resource inputs to components which make up the majority of a tire; it is expected that tires will still be comprised of elastomers, fabrics, steel, silica, carbon black, *etc.* 6PPD (or a possible alternative) comprises only a small percentage of the mass of a tire, so even if the resource inputs required for an alternative were to be significantly different from 6PPD, the overall impact on the resource inputs for the tire would be small. It seems likely that production of alternate PPDs would involve similar resource inputs and consumption as 6PPD. Many of the non-PPD inputs also involve some of the same raw ingredients (*e.g.*, aniline) so their production pathways should not be materially different in terms of their impact on resources. Some of the possible alternatives are at least partially mineral in nature (*e.g.*, graphene, carbon nanotubes, nickel dibutyldithiocarbamate) and so their processes are likely to be different but data are lacking to allow for comparisons to 6PPD. Lignin is a waste product of wood product manufacture, but the production of amine functionalized lignin would introduce energy and chemical inputs. Rambutan peel extract similarly involves a waste product as a starting ingredient with further chemical processing. Octyl gallate can be obtained from plant materials but how this could be done at the scale needed to meet tire production is unknown. Details about production processes are limited based on internet searches for their producers or the processes involved. It is also conceivable that some possible alternatives would be produced at different locations which could have different impacts in terms of raw material and chemical intermediate transportation (both in terms of distance and transportation mode). However, data are lacking to assess such effects and moreover, transportation networks would likely change significantly to increase efficiency due to the large volume of antidegradant involved. Similarly, with data lacking on the particular production processes required for many of the non-PPD alternatives, it is not possible to know how exposure potential might vary during this life cycle phase. Exposure potential for the different PPD alternatives is likely to be similar to that of 6PPD unless different process chemistry is required. Overall, whether resource inputs and consumption during production would be materially different between 6PPD and the possible alternatives is unknown at this time.

4.7.3 Intermediate Materials Processes

Intermediate materials processes refers to chemicals that are produced in the synthesis pathways of 6PPD and its possible alternatives. If an alternative involves a particularly hazardous (or non-hazardous) component during its production, that could constitute a material difference relative to 6PPD. On the other hand, an alternative that eliminates a hazardous chemical used during the production process would be preferable. Review of information on the chemical precursors of the functional ingredients in the Priority Product and possible alternatives (as summarized in Table 4.6) suggests that the PPD-related alternatives have essentially equivalent intermediate materials and processes as 6PPD. The non-PPD materials (*e.g.*, TMQ, ethoxyquin, NBC, DLTD, graphene, carbon nanotubes) involve different chemistries but all appear to involve industrial chemicals with some significant hazard. The hazards of graphene and carbon nanotubes depend on the structure (*i.e.*, thickness and aspect ratio) and stage of the production process.

As shown in Table 4.6, amine functionalized lignin may involve some hazardous chemistries in lignin extraction (*e.g.*, methanol) or amine functionalization but details are lacking. Rambutan peel extract may similarly involve hazardous chemicals in extraction (*e.g.*, ethanol, methanol); less hazardous extraction solvents (*e.g.*, hydrochloric acid) appear possible but all extraction process data appears related to small scale production; the chemistries appropriate for large scale production are unclear. From what is known regarding production of octyl gallate, chemical derived from natural sources (*e.g.*, fatty acid esters) does not appear to involve particularly hazardous chemistries although production from fossil fuel sources does involve some hazardous reagents (nitrous acid and p-cresol). Overall, it appears unlikely that intermediate materials processes are materially different among 6PPD and the various possible alternatives both in terms of potential risks for exposure and potential impacts on the environment.

4.7.4 Manufacture

We interpret this life cycle stage as relating to the manufacturing of the tire itself (*i.e.*, the priority product) as earlier steps in the life cycle (*e.g.*, manufacturing of tire ingredients) are discussed in sections 4.7.2 and 4.7.3). The basic process of tire manufacturing described earlier (*i.e.*, mixing the individual compound, assembling each component, and then building the tire from the inner side outwards in a tire assembly machine) will likely remain the same for the foreseeable future. As indicated in Tables 5.1 to 5.3, all the possible alternatives pose some hazards which could be relevant for workers during exposure. 6PPD and a number of the possible alternatives (DTPD, CCPD, ethoxyquin, Irgazone 997, N-phenyl naphthalenes, and octyl gallate) are category 1 skin sensitizers; as already mentioned, this could expose workers who do not wear appropriate PPE (in violation of employer instructions). Other possible alternatives (graphene, carbon nanotubes, DLTP, NBC) do not have this hazard and would present less risk. Many of the latter do have other hazards (*e.g.*, NBC is a carcinogen, ethoxyquin has systemic toxicity) so this may not constitute a material difference. In addition, there are many toxicity data gaps for a number of the possible alternatives so the potential hazards for workers from these chemicals is hard to judge.¹² Whether existing methods for controlling worker exposure during production can also be employed for the alternatives is also unknown. Overall, 6PPD and all of the possible alternatives have some hazardous properties involved in their manufacture (Table 4.6) These range from aniline and its precursors for the PPD alternatives to nickel, quinoline, ethoxyaniline, and various mineral acids. It should be noted that 6PPD (or a possible alternative) comprises a small percentage of the mass of the tire and it is assumed that all other ingredients (*e.g.*, elastomers, fabric belts, steel, carbon black, silica, other additives) will largely remain the same and contribute the same level of hazard and potential for exposure. The extent to which some additives may change with a new antidegradant is also not currently known. Moreover, tires will still require vulcanization which constitutes the major source of energy required during the production process. Thus overall, changing the antidegradant may not have a material difference on the impacts of the manufacturing stage but data are too limited to be certain.

4.7.5 Packaging

There appears to be no material difference among the priority product and the possible alternatives under consideration in terms of the type of packaging that would be used. Tires are shipped in shipping containers, on pallets or individually, depending on the needs of the commercial customer. Any alternative would likely have the same general weight and dimensions as an existing tire so the method of packaging would not be expected to be different. Regarding the antidegradant itself, it is also anticipated that a chemical

¹² It should be noted that for chemicals to be used in large volumes such as would be required for an antidegradant in tires, these toxicity data gaps would have to be filled under various global chemical registration programs. This would allow for a better understanding of these hazards; however, the data are not currently available.

alternative to 6PPD would likely have a similar volume and density as 6PPD, therefore no significant change in raw material packaging would occur as a result of substitution of an alternative, unless higher quantities were required to offset any difference in mobility or reactivity vs. 6PPD. In terms of exposure potential, 6PPD has very low volatility and would not pose a potential for exposure during the packaging stage. Potential worker exposure should be similarly low for all possible alternatives in the packaging stage; alternatives that have excessive volatility or otherwise migrate out of the tire into the workspace would defeat the purpose of having a long lasting antidegradant in the tire. Overall, there is no expectation that switching to an alternative product would require either more or less packaging.

4.7.6 Transportation/Distribution

Transportation/distribution of the priority product and/or chemical of concern is considered to be an insignificant pathway in terms of 6PPD migration to the environment because the tires on the vehicles used for this purpose generate a very small fraction of the total TRWP generated on an annual basis in California and, as a result, pose minimal potential for significant exposure. Additionally, the tires being transported do not emit the chemical of concern during transport for distribution or sale. There is no evidence that transportation impacts (*e.g.*, from chemical suppliers to formulators; from formulators to retail outlets) would be different among the priority product or any of the possible alternatives under consideration. For example, 6PPD and its possible alternatives do not constitute the bulk of the product weight, so shipping tonnage would not be expected to be different. Depending on the production of the alternative (*e.g.*, at locations more or less distant from tire manufacturing facilities) there could be an impact on the transportation/distribution portion of the life cycle. However, no data are available to assess this potential impact since an alternative has not been definitively identified. It is also likely that cost would incentivize minimizing transportation of raw ingredients to tire production facilities so transportation impacts (*e.g.*, CO₂ emissions, TRWP generated from transport trucks) from the antidegradant production facility to tire production locations may not significantly change but this is unclear at the present time. In terms of potential for exposure during the transport phase, as noted above, an alternative that had a greater potential to volatilize or otherwise be emitted from the tire than 6PPD would likely not be a suitable replacement.

4.7.7 Use

Use is one area where the possible alternatives may have materially relevant differences to 6PPD, because the use phase of the product involves generation of TRWP and washing off of the antidegradant present on the tire surface. In addition, if a new alternative changes the abrasion rate of a tire, that will have an impact on TRWP generation. If the alternative also has differential hazards *versus* 6PPD (as some appear to do) this could be a materially relevant difference. If alternatives can reduce the release of 6PPD (or another chemical with similar toxicity to susceptible species) to the environment, then there would be a material difference in this parameter. Beyond the reported effect of 6PPD on certain salmon species, there are other aspects of the use phase which will need to be considered. One important consideration would be whether an alternative results in greater or lesser tire wear, potentially resulting in different environmental impact. However, TRWP generation rate likely depends more on driving conditions (*e.g.*, vehicle, load, speed, drive cycle, road surface type) than the antidegradant. Any alternative that could be implemented in a reasonable timeframe would still be rubber-based. Given the potential for a reduction in impact of the antidegradant, this does appear to be a factor that will be materially relevant to alternative selection.

The use phase may also consider storage of the tires when not in use (*e.g.*, in an attached garage), in the vehicle trunk (*e.g.*, spare tires), or in a distribution facility. Again, the low volatility of 6PPD does not indicate significant exposure during storage and an alternative that is more volatile or otherwise migrates

out of the tire during storage would not satisfy the goals of having a long-term reservoir of antidegradant in the tire.

4.7.8 Operation and Maintenance

Tires require little maintenance while in actual use. The maintenance that is required (*e.g.*, maintaining tire pressure, tire rotation, balancing) would not be expected to change with any of the possible alternatives. This phase of the product lifecycle is also not associated with release of 6PPD from the tire and exposure of any potential receptor. Consortium members cannot conceive of a mechanism by which this would be different for any of the possible alternatives given that the basic nature of a tire will remain the same. In terms of exposure potential, all antidegradants will be required to be present on the surface of the tire to act against ozone. Thus, dermal contact (*e.g.*, during tire rotation or changing) may be possible but would occur for all antidegradants to some degree (the extent is unknown). Overall, operation and maintenance is unlikely to be a relevant factor among 6PPD and the possible alternatives.

4.7.9 Waste Generation and Management

We interpret this stage of the lifecycle to refer to production waste during tire production. TRWP are a wear product generated during the use phase but the impact of these is discussed in Section 4.7.7. Manufacturers cycle excess formulated compound back into the manufacturing process (called rework); this substantially minimizes waste generated during tire production. The ability to continue the rework process is critical for minimizing production waste and will need to be considered for any alternative. For example, as noted, earlier Consortium members' experience suggests it may be difficult to use modified EPDM or bromobutyl rubber as rework in production due to issues of behavior with other tire additives (*e.g.*, carbon black) and is one of the reasons why they were not included in the AA. Any alternative antidegradant that impacts processing time or temperature stability could significantly impact the potential for rework. The extent to which any of the alternatives affect rework is not known at this time. It is also unclear to what extent worker exposure to possible alternatives from production waste management could differ. Although many of the physico-chemical properties of the alternatives would need to be similar to be effective in a tire, how the waste would be managed during production is unknown. Overall, this stage of the life cycle has the potential to be substantially different among the possible alternatives.

4.7.10 Reuse and Recycling

As shown in the conceptual model for tires (Figures 4.1 and 4.2), about half of passenger tires in California are reused or recycled at the end of their useful life. Significant portions of the spent tire stream is re-used as fill material (road paving or crumb rubber infill), as structural materials (*i.e.*, sea walls) or burned for energy (*e.g.*, in cement kilns). When burned for energy in a cement kiln or incinerator, 6PPD is likely degraded to CO₂ and other gases; a typical operating temperature for a cement kiln is well over 1000°C and tire pyrolysis is reported to occur at temperatures ranging from 300°C to 700°C (Zerin *et al.*, 2023). The flashpoint of 6PPD is reported to be 202°C (see Appendix C), meaning that 6PPD would be consumed during the thermal processing of tires. US EPA (2016) noted "Laboratory testing of a rotary kiln incinerator simulator (RKIS) indicated that efficient combustion of supplemental TDF [tire-derived fuel] can destroy many volatile and semivolatile air contaminants. However, it is not likely that a solid fuel combustor without add-on particulate controls could satisfy air emission regulatory requirements in the US."

One particular consideration for truck and bus tires is retread. An alternative that interferes with the retreading process could substantially increase tire waste because new truck and bus tires would need to be

purchased and discarded more frequently. Depending on the possible alternative there could also be an increased or reduced potential for exposure of retread facility workers. During retreading, the old worn tread is "buffed" away to expose the tire casing. The tire tread is then rebuilt and the tire is cured in an analogous process to original tire manufacturing. Exposure may occur during these processes. It is not clear how implementation of possible alternatives might affect the retread processes and potential exposure of retread workers. It is assumed that major effects on the retread process would not be tolerable to manufacturers but how retread might differ with another antidegradant remains to be investigated. Overall, the reuse and recycling stage of the life cycle has the potential to be substantially different among the possible alternatives.

4.7.11 End-of-life Disposal

According to CalRecycle, in 2021, 45% of the passenger tires waste stream was landfilled, 16% was used as tire derived fuel, and 35% was recycled, for example as crumb or ground rubber or retreading for bus or heavy-duty truck tires, *etc.* (CalRecycle, 2023). Note that use as tire-derived fuel and use as crumb rubber are classified as reuse and are discussed in Section 4.7.10. If tires with alternative antidegradants have a different lifespan this could impact the amount of post-manufacturing tire waste generated and could exceed reuse and recycling capacity. It is also possible that chemicals can leach out of tires and impact the environment from improperly designed or operated disposal facilities. Overall, the end-of-life stage of the life cycle has the potential to be substantially different among the possible alternatives.

5 Comparison of Alternatives

5.1 Hazard

5.1.1 Hazard Evaluation Approach

According to the SCP Regulation (CalDTSC, 2013a), a hazard evaluation comparing 6PPD and possible alternatives must include hazard endpoints from the Green Chemistry Hazard Traits defined in the California Code Of Regulations, Title 22, Division 4.5, Chapter 54.¹³ Gradient organized the human health hazard endpoints into two groupings (*i.e.*, Group A and Group B). Group A hazard endpoints have corresponding GHS hazard endpoints (*e.g.*, acute toxicity, carcinogenicity, mutagenicity), which allowed for transfer of existing hazard assignments according to each chemical's ECHA Registration, Evaluation, Authorisation, and Restriction of Chemicals (REACH) dossiers and GreenScreen assessments, if available. Some additional hazard endpoints, not included among the Green Chemistry Hazard Traits but necessary for our scoring system, were also added to the evaluation of Group A endpoints (*i.e.*, systemic organ toxicity, dermal and respiratory sensitization). The latter two endpoints were also evaluated as part of the SCP hazard trait of immunotoxicity.

Group B hazard endpoints are those that do not have corresponding GHS hazard endpoints (*e.g.*, ototoxicity, hematotoxicity, immunotoxicity, cardiovascular toxicity). To a large extent, these types of specific toxicity are subsumed in the larger category of "systemic toxicity," which *is* addressed in ECHA dossiers and GreenScreen assessments under Systemic Target Organ Toxicity – Repeated Exposure.¹⁴ Nonetheless, to comply with the SCP regulations, we addressed these remaining health endpoints (*i.e.*, discussed herein after as "Group B" endpoints) by reviewing ECHA dossiers, supplemented by GreenScreen assessments, for data on these particular health effects.

5.1.1.1 Hazard of Constituents *versus* Risk of Final Products

It is important to stress that while individual chemical-specific hazards are presented for possible alternatives in this section, chemical-specific hazards do not necessarily reflect the hazards of the actual final product (*i.e.*, a tire). Thus, when reviewing chemical-specific hazard data obtained from testing of individual product ingredients (such as anti-degradants), the indication of a hazard does not necessarily equate to an actual human or ecological health risk caused by using the chemical in the tire.

¹³ This evaluation is based on a literature review of the available studies and did not involve an independent verification of the results of any study.

¹⁴ Two of the discretionary endpoints added to Group A, namely skin sensitization and respiratory sensitization, partially fit under the Group B endpoints (dermal toxicity, respiratory toxicity and immunotoxicity) but do not fully address all forms of toxicity that might fit under these categories. As noted above, these group B endpoints are not fully addressed by GHS hazard criteria. To comply with the SCP regulations, where one of these Group A endpoints is considered relevant, the corresponding Group B endpoint is considered relevant.

5.1.1.2 Group A Endpoints

For the Group A human health hazard endpoints (*e.g.*, carcinogenicity, mutagenicity, reproductive and developmental toxicity) (summarized in Table 5.1), we reviewed the hazard properties of 6PPD and the possible alternatives for hazard properties using mainly ECHA REACH dossiers (ECHA, 2024) and existing GreenScreen assessments, if available.

There are a number of additional potential hazard concerns required by the SCP regulations that are not classified in the ECHA dossiers. These were addressed as follows:

- **Endocrine Disruption and California Proposition 65.** The European Union's (EU) Endocrine Disruptor Priority List and the California Proposition 65 list were used to inform these endpoints (UL LLC, 2023).
- **Terrestrial Toxicity.** Pharos (Healthy Building Network, 2019) was used to inform this endpoint.
- **Bioaccumulative Potential.** Chemicals are considered bioaccumulative if the bioconcentration factor (BCF) is >1,000 according to California Code of Regulations, according to title 22, Division 4.5, Chapter 54, Article 5 (CalOEHHA, 2012).
- **Persistence.** Based on the Globally Harmonized System of Classification and Labelling of Chemicals (GHS) (UN, 2019), possible alternatives are considered persistent if 0 to <20% of the chemical degrades within 28 days, inherently biodegradable if 20 to <60% of the chemical degrades within 28 days, and readily biodegradable if 60 to 100% of the chemical degrades within 28 days.
- **Global Warming Potential (GWP).** We compared the possible alternatives to the greenhouse gases listed in Table 8.a.1 of the "Fifth Assessment Report of the Intergovernmental Panel on Climate Change (IPCC)" (IPCC, 2013). Chemicals that are neither gases nor chlorinated/fluorinated were considered to have negligible GWP.
- **Ozone-Depleting Potential (ODP).** US EPA's list of ozone-depleting substances (US EPA, 2018b) was used to evaluate this endpoint. Chemicals that are neither gases nor chlorinated/brominated were considered to have negligible ODP.
- **Clean Air Act VOC Contributing to Smog Formation.** We assessed whether each possible alternative is a volatile organic compound (VOC); a chemical was considered to be a VOC if it had a vapor pressure equal to or greater than 0.1 mm mercury (Hg) based on criteria in CARB (2009). Additionally, we noted whether the chemical is listed as a substance exempted under 40 CFR § 51.100 (as per CARB, 2009).

To meet the SCP regulations' requirement for an easily understood matrix of hazards, we adapted the color-coding system used by various hazard evaluation tools, such as the GreenScreen hazard evaluation system (Clean Production Action, 2019). This employs a red/orange/yellow/green "heat map"-type color coding to allow the reader to easily compare the hazards of different chemicals at a high level. In addition, we added light grey shading to the endpoints for which no data were found (*i.e.*, data gaps). It should be noted that data gaps do not indicate a lack of toxicity; they merely indicate that no information was found.

5.1.1.3 Group B Endpoints

For group B endpoints (*e.g.*, ototoxicity, cardiovascular toxicity), we qualitatively summarized the reported findings concerning these adverse effects or the lack of relevant adverse effects, as well as any data gaps (Table 5.2). In conducting our review, we focused primarily on repeated-dose studies, because these typically have the most detailed evaluation of potential health effects, whereas acute dosing studies often

only examine a limited number of health effects using gross measures (*e.g.*, clinical signs, organ weight changes). This is a qualitative approach, but we believe that the alternative approach (creating an arbitrary and novel GHS-like scoring rubric for all of the additional SCP hazard endpoints that lack recognized classifications like the GHS) would be unreasonably burdensome and problematic, because, as noted above, many of these health effects are already addressed in the larger category of systemic toxicity. As noted earlier, when a discretionary Group A endpoint (*e.g.*, respiratory or dermal sensitization) was considered to be materially different among the possible alternatives, the corresponding Group B endpoint (immunotoxicity) were also considered relevant. Finally, for some Group B endpoints we took the following approaches for certain Group B endpoints:

- **Epigenetic Toxicity.** We noted from our review whether possible alternatives were or were not genotoxic. Genotoxicity generally implies changes in the DNA sequence, which is outside the scope of epigenetic toxicity, but genotoxicity also implies a potential for interaction with DNA, so it is evaluated given that more direct data on epigenetic effects are lacking. In addition, we looked for other relevant information in our data sources regarding other types of DNA activity (*i.e.*, altered methylation).
- **Reactive in Biological Systems.** In their Priority Product profile, DTSC cited this as a factor of concern. We are unable to make a determination about this relevant factor for a number of possible alternatives due to lack of hazard data. For 6PPD, DTSC listed 6PPDQ as reactive in biological systems in the Priority Product Profile (CalDTSC, 2022).
- **Immunotoxicity.** We included respiratory and dermal sensitization as relevant under this endpoint, as these are immune system-mediated effects.

Again, it should be noted that the chemical-specific hazards presented in Tables 5.1-5.4 for the possible alternatives do not represent the potential hazards or risk of finished tires. As part of the tire production process, the individual tire ingredients are chemically altered *via* various processes (*e.g.*, cross-linking, degradation) (Bebb, 1976) that make it difficult to quantitatively extrapolate from the risk of the individual ingredients tested as single substances to that of the finished product in a reliable manner. In addition, the finished tire limits the ability of 6PPD to migrate (*i.e.*, relative to the exposed surface area of the tire, concentration and accessibility of 6PPD is low).

5.1.1.4 Salmonid Acute Toxicity

Ecotoxicity data evaluated in Group A were obtained from ECHA dossiers which primarily relied on Organisation for Economic Co-operation and Development (OECD) Test Guidelines (TGs). Typical OECD TG test species of fish include zebrafish (*Danio rerio*), fathead minnow (*Pimephales promelas*), carp (*Cyprinus carpio*), Japanese medaka (*Oryzias latipes*), guppy (*Poecilia reticulata*), bluegill (*Lepomis macrochirus*), rainbow trout (*Oncorhynchus mykiss*), three-spined stickleback (*Gasterosteus aculeatus*), sheephead minnow (*Cyprinodon variegatus*), European sea bass (*Dicentrarchus labrax*), and red sea bream (*Pagrus major*) (see for example, OECD TG No. 203 and No. 210). Coho salmon are not an OECD TG test species. Because DTSC listed 6PPD due to effects on coho salmon and certain other salmon species, we also gathered available published acute toxicity data in salmonids more broadly.

For each possible alternative, we conducted a comprehensive literature search to identify relevant lethal concentration 50 (LC₅₀) data for the parent chemical and quinone product if applicable (*i.e.*, phenylene diamines). We focused specifically on data reported in the peer-reviewed literature and as summarized in scientific and regulatory agency reports (such as DTSC and WA DOE) for organisms in the Salmonidae family (*e.g.*, genera *Salmo*, *Salvelinus*, *Oncorhynchus*), based on phylogenetic relationship to coho

salmon. Species in genus *Salmo* include Atlantic salmon (*Salmo salra*) and brown trout (*Salmo trutta*). Species in genus *Salvelinus* include Arctic char (*Salvelinus alpinus*), brook trout (*Salvelinus fontinalis*), and white-spotted char (*Salvelinus leucomaenis pluvius*). Species in genus *Oncorhynchus* (other than coho salmon, *Oncorhynchus kisutch*) include Chinook salmon (*Oncorhynchus tshawytscha*) and rainbow trout (*Oncorhynchus mykiss*). We conducted searches of the scientific literature in the PubMed, Scopus, and US EPA ECOTOX databases, agency reports (e.g., DTSC, WA DOE), and, as mentioned, ECHA REACH dossiers. For PubMed¹⁵ and Scopus¹⁶ literature searches, we searched the common name and CASRN of each chemical in a search string to identify aquatic toxicity data in salmonids. In order to provide the most conservative evaluation in the current AA, we identified the lowest reported LC₅₀s for each possible alternative for both the parent chemical itself and its quinone product if applicable and available. Other studies may have reported higher LC₅₀ values. We also reported the duration of exposure (e.g., 24 hrs, 96 hrs), experimental flow conditions (e.g., flow-through, static) and whether the exposure concentrations were nominal or verified by experimental measurement. Results of the salmonid acute toxicity evaluation are presented in Table 5.4.

5.1.1.5 USGS studies of alternatives involving cell lines

Although the SCP program does not require generation of additional data, under sponsorship from USTMA, the US Geological Survey (USGS) have conducted initial studies on a subset of PPD-related possible alternatives, specifically, CCPD, 77PD, and DPPD, with 6PPD studied for comparison. These three phenylene diamines were selected because they have slightly different chemical structures (alkyl alkyl or aryl aryl substitutions) compared to 6PPD (alkyl aryl substitution), or they were selected because they were mentioned as possible alternatives by documents published by California DTSC (CalDTSC, 2022) and/or Washington Department of Ecology (WA Ecology, 2021). The USGS authors had previously published a study demonstrating that the *in vitro*, Pacific salmon cell system was able to partially replicate the species-specific differences in susceptibility to 6PPDQ reported in whole animal studies (Greer *et al.*, 2023a). The current studies used cell lines derived from two Pacific salmon species, coho and Chinook. The goal of these cell-based studies was to determine whether the selected alternatives produced toxicity in salmonid cells in a manner similar to 6PPD. Given the difficulty in conducting screening studies in whole salmon (e.g., time, cost, availability, low throughput) and the need for new approach methodologies that limit the use of live animal screening, these studies were also intended as proof-of-concept investigations to determine whether a cell-based screening approach would provide a rational basis for identifying a subset of possible alternatives to 6PPD.

The studies conducted in collaboration with the USGS focused on the selected possible alternatives as well as their ozonation products. Rather than isolated chemical solutions, the studies involved extracts of tire rubber that had been formulated with the different antiozonants at a standard concentration. Strips of the rubber were subjected to ozone at three different concentrations (0, 10, and 40 parts per hundred million (pphm)). Strips were then eluted in 100% ethanol overnight. A portion of each extract was sent to an

¹⁵ As an example PubMed search, the search string for IPPD was as follows: (101-72-4[EC/RN Number]) OR ("N-isopropyl-N'-phenyl-p-phenylenediamine"[tiab:-0] OR IPPD) AND (oncorhynchus OR ecotox*[Title/Abstract] OR aquatic[Title/Abstract] OR ecolog*[Title/Abstract] OR ecosystem*[Title/Abstract] OR fish[Title/Abstract] OR salmon[Title/Abstract] OR trout[Title/Abstract] OR "marine organisms"[Title/Abstract] OR "aquatic organisms"[Title/Abstract] OR "freshwater"[Title/Abstract] OR wildlife[Title/Abstract] OR fauna[Title/Abstract] OR "Ecotoxicology"[Mesh] OR "Aquatic Organisms"[Mesh] OR "Ecosystem"[Mesh] OR "Fishes"[Mesh] OR "Animals, Wild"[Mesh] OR "Ecology"[Mesh] OR "Salmon"[MeSH] OR "Trout"[Mesh]) NOT (zebrafish OR Human OR mice).

¹⁶ As an example Scopus search, the search string for IPPD was as follows: (CASREGNUMBER (101-72-4) OR TITLE-ABS-KEY ("IPPD" OR "N-isopropyl-N'-phenyl-p-phenylenediamine")) AND TITLE-ABS-KEY (ecotox* OR aquatic OR fish OR salmon OR trout OR "marine organisms" OR "aquatic organisms" OR "freshwater" OR wildlife OR invertebrates OR oncorhynchus) AND NOT TITLE-ABS-KEY (zebrafish OR human OR mice).

analytical laboratory for quantification of parent compounds and associated quinones. The rubber extracts were then tested at different concentrations in both the coho-derived cell line (CSE-119) and Chinook cell line (CHSE-214). Because the research is being conducted under a Cooperative Research and Development Agreement (CRADA) with USGS, which intends to publish the results in a peer reviewed journal, full details of the methods cannot be provided here but may be able to be shared with DTSC by USTMA as confidential business information. A brief, preliminary overview of the results of these studies is provided below in Section 5.1.3.5.

5.1.1.6 Transformation Products

As required by the SCP regulations, we also identified the main transformation products of the possible alternatives and reviewed their chemical properties and potential toxicity (Table 5.10). We identified potential transformation pathways and products mainly *via* ECHA REACH dossiers (ECHA, 2024). We then reported the classified GHS hazards of the potential transformation products *via* the ECHA dossiers of the transformation products. Additionally, we noted if any transformation product is on the EU Persistent, Bioaccumulative, and Toxic (PBT) list, the California Toxic Air Contaminant (TAC) list, and/or the California Proposition 65 list, using Underwriters Laboratories Inc.'s (UL) List of Lists (LOLI) (UL LLC, 2023). In Table 5.10, possible alternatives that were present on any of these lists or which had significant toxicity under GHS classification (*e.g.*, carcinogenicity category 1, acute or chronic toxicity category 1, mutagen) were flagged with orange shading.

Prior to reliance on information in ECHA dossiers, we evaluated the potential to conduct analyses with the Open (Quantitative) Structure-Activity/Property Relationship App (OPERA) and the OECD QSAR Toolbox. Overall, neither program yielded useful information and in fact, while OPERA can predict physical-chemical properties, environmental fate parameters, and toxicity endpoints (Mansouri *et al.*, 2018), it does not have a module to predict transformation products. Our methodology and findings are discussed briefly below.

Regarding hydrolysis, we used the OECD QSAR Toolbox hydrolysis simulator at pH neutral, acidic, and basic. Under these conditions, none of the hydrolysis simulators predicted transformation products for any PPD-based alternatives, most likely because the p-phenylenediamine moiety (present in 6PPD and similar PPDs) may not be included in the software's hydrolysis model training set. In contrast, for two non-PPD alternatives, 6QDI and dilauryl dithiopropionate, hydrolysis transformation products could be modeled based on hydrolysis at their imine and ester bonds, respectively. The modeled hydrolysis products were identical to those reported in the ECHA REACH dossiers for the possible alternatives (described below).

Regarding ozonation and oxidation, we looked for tools that could address these transformation pathways. We did not find programs that could model transformation products through the ozonation pathway. The QSAR Toolbox does not contain an ozonation simulator, but does contain an autoxidation simulator. Autoxidation is a free radical reaction of a chemical with molecular oxygen that results in the formation of oxidation products of 6PPD (OECD, 2017). The QSAR Toolbox autoxidation simulator did not predict 6PPDQ as one of the oxidation products. We note that although 6PPD can react with ozone or potentially ozone-related secondary oxidants (*e.g.*, hydroxyl radical), no significant degradation of 6PPD in zero-grade (ozone-free) air was observed experimentally after 6 hours of exposure, as reported by Hu *et al.* (2022).

As mentioned, due to the lack of utility using QSAR modeling approaches to evaluate transformation products of the alternatives, we identified potential transformation pathways and products mainly *via* ECHA REACH dossiers (ECHA, 2024). We did not conduct a search of peer reviewed literature for transformation products of the alternatives but note that Cao *et al.* (2022) reported formation of respective quinone products of 6PPD, CPPD, DPPD, DTPD, and IPPD in environmental samples in Hong Kong

(e.g., urban runoff, roadside soils, and air particles). In addition, Johannessen *et al.* (2022) reported various transformation products of 6PPD in passive air samples from 18 cities (*i.e.*, 6PPDQ, 6PPD TP181, 6PPD TP198, 6PPD TP212, 6PPD TP256, 6PPD TP274, 6PPD TP282, 6PPD TP298, and 6PPD TP373).

ECHA REACH dossiers provide some information on potential transformation products but are incomplete in terms of the range of possible transformation products covered. Data on potential transformation products was available for 6PPD and six of the 43 possible alternatives (Table 5.10). The six possible alternatives were: five PPD derived chemicals (7PPD, 77PD, IPPD, commercial DTPD, and DAPD) and the non-PPD alternative 6QDI. These six possible alternatives had hydrolysis studies reported in the ECHA dossier. The 37 remaining possible alternatives did not have ECHA REACH dossiers or their respective dossiers did not identify transformation products in their hydrolysis studies.

Among the six possible alternatives with data in ECHA REACH dossiers, 11 potential hydrolysis products were identified. According to ECHA, most PPDs have similar transformation pathways for hydrolysis where the first step is the cleavage of the alkyl chain resulting in a phenolic chemical (*e.g.*, 4-hydroxydiphenylamine for 6PPD, 7PPD, and IPPD) and an alkylamine (ECHA, 2024). The structure of the alkylamine will vary due to PPDs having different alkyl chain lengths. For example, for 6PPD the alkylamine formed is 1,3-dimethylbutylamine, whereas for 7PPD the alkylamine formed is 1,4-dimethylpentylamine. Most PPDs are currently understood to form a quinone-imine transformation product which may be from the oxidation of the phenolic chemical. The secondary hydrolysis products are usually p-benzoquinone and p-hydroquinone, and in some cases, an amine due to the cleavage of the second amino group. For PPDs linked to phenyl groups (*e.g.*, 6PPD, 7PPD), the amine formed is aniline. Most PPDs are expected to follow a similar transformation pathway and produce similar transformation products. Quinones were not listed as a transformation product in any of the ECHA dossiers of any of the examined chemicals.

5.1.2 Hazard Scoring Approach

We quantitatively scored hazards of 6PPD and possible alternatives using an adaptation of the Chemical Scoring Index (CSI). The CSI is a largely GHS-based tool for ranking the hazards of chemicals in oil and gas products (Verslycke *et al.*, 2014). The CSI has been used in prior AAs that have been accepted by DTSC. The CSI considers not only the hazard but also the percentage of each chemical in the product formulation. These two pieces of information are combined using a scoring matrix to arrive at a total hazard score for the chemicals in the product. The original form of the CSI is heavily focused on acute toxicity hazards and did not have all the endpoints required under the SCP regulations (Verslycke *et al.*, 2014), so some modifications to the CSI were required for this assessment. The modifications to the original CSI approach consisted of the following, and are also described in Tables 5.5-5.7:

- **No data substances.** Gradient did not attempt to score chemicals that have no data, since doing so would result in low scores, which could be interpreted as less hazardous compared to chemicals with higher scores based on data. We also did not use predictive toxicity modeling software to fill endpoints such as aquatic toxicity or dermal sensitization because doing so would unfairly give data-poor compounds a scoring advantage compared to data-rich compounds. The majority of the data-gap endpoints cannot be modeled, thus data-gap penalty scores, which are always lower than the score of the most severe classification, would be applied. For example, DOPD CAS 101-67-7 is a complete data-gap chemical. If we were to score DOPD using the data-gap penalty scores, its total score would be 220, which would make DOPD appear as a less toxic alternative than 6PPD, a data-rich chemical, that has a total score of 275. However, DOPD should not be considered a less toxic alternative to 6PPD because DOPD lacks toxicity information.

- **Mixtures.** One of the possible alternatives being evaluated in this Stage 1 AA is a mixture of nitrones as a class and Lowinox WSP. While hazard data was identified for Lowinox WSP, no hazard data was identified for nitrones as a class. *If* hazard data were identified for nitrones as a class, then we would have used GHS mixture classification rules (UN, 2019) to classify the mixture based on hazards and percentage of the individual components. Note, it is also important to know if individual components in a mixture would react in a way resulting in a set of hazards that do not reflect the hazards of the individual components (*e.g.*, monomers and additives resulting in a polymer). It is not known what type of reaction nitrones as a class and Lowinox WSP would have and whether this would have an effect on the hazards of the mixture.
- **Assigning a penalty for endpoint-specific data gaps for data-poor chemicals.** The original CSI approach does not penalize data gaps on an *endpoint-by-endpoint* basis. It only penalized a product if <30% of its composition is accounted for by components with no data, with a maximum penalty score of 100 for the environmental categories, 100 for the human health categories, and 50 for the physical categories (if ≥30% of a product's composition is accounted for by components with no data, it would not be evaluated [see above]). Thus, the CSI lacks granularity in terms of how many or which health endpoints have missing data. For this AA, we added endpoint by endpoint penalty scores for data gaps, which is more conservative than the CSI's approach. These data gap scores were assigned based on hazard severity (*i.e.*, the maximum carcinogenicity and mutagenicity data gaps are scored 50 *versus* 10 for endocrine disruption). Also, in general, data gap penalty scores are lower than the Category 1 hazard scores for the same endpoint, and data gap penalty scores generally decrease with decreasing chemical concentrations, except for some categories of particular concern (*e.g.*, Category 1 carcinogens).
- **Chronic aquatic toxicity.** The CSI does not have scores for chronic aquatic toxicity; thus, the CSI's scoring system for acute aquatic toxicity was used.
- **Terrestrial toxicity and GWP.** The CSI does not have scores for terrestrial toxicity or GWP; thus, scores for these metrics were created.
- **Mutagenicity, reproductive/developmental toxicity, and systemic toxicity single- and repeated-dose toxicity.** Under the original CSI approach, scores did not differ between the GHS subcategories for mutagenicity, reproductive/developmental toxicity, and systemic toxicity single- and repeated-dose toxicity. To provide more granularity in the scoring, for this AA, we adopted the maximum CSI score for Category 1 for all of the abovementioned hazard endpoints, but scaled down to a lower score for subsequent subcategories (approximately 50% of the Category 1 score for Category 2, and so on). This approach is in line with the spirit of the GHS and CSI. Note that the CSI implemented lower scores for Categories 2 and below for carcinogenicity, corrosivity, and acute mammalian and aquatic toxicity, but not for the four abovementioned endpoints.
- **Endocrine.** We moved the endocrine hazard endpoint from ecological toxicity to human health toxicity. Additionally, we used a score of 25, instead of the original 50 in the CSI, for endocrine disruptors, because the EU's Endocrine Disruptor Priority List, which we used for this assessment, is a listing of chemicals with endocrine *concern* that should be explored *via* testing, rather than a list based on studies showing actual effects. In contrast, the maximum score for mutagenicity is 50 and is based on positive findings of a mutagenic effect.
- **Skin and respiratory sensitization.** We created separate skin and respiratory sensitization categories from the original CSI's "sensitizer" category. Additionally, we used a maximum score of 50, instead of the original 25 in the CSI, for skin and respiratory sensitization. This is because the original CSI approach was developed for oil and gas applications, in which sensitization was less of an issue.

- **VOCs contributing to tropospheric ozone formation.** We used a maximum score of 75, instead of the original 50 in the CSI, for this endpoint. Because smog formation is a particular concern for California cities, we increased the maximum score for this endpoint.
- **Eye and skin irritation.** We created separate categories for eye and skin irritation from the "irritant" category in the original CSI to be more consistent with the required SCP regulations' toxicity categories. We assigned a maximum data gap penalty score of 25 for products in which components with no data account for more than 30% of the composition, matching the score of 25 for Category 1 skin or eye irritants, because these are common hazards.

When the original CSI approach provided numerical scoring values for an endpoint, we used those scores, other than the abovementioned deviations for endocrine disruption, skin and respiratory sensitization, and VOCs contribution to tropospheric ozone formation. When scores for endpoints were created, we employed scores that were consistent with similar endpoints (*e.g.*, we used the same scoring used for "irritation" in the original CSI approach for the new eye and skin irritation scores). In our scoring approach, we did not score Group B endpoints (Table 5.2) or acute toxicity in salmonids, because any adverse effects that rise to the level of GHS classification would already be captured under the single target organ toxicity – repeated exposure endpoint and acute aquatic toxicity, respectively, and we wanted to avoid "double counting." We also did not attempt to score chemicals that have no data, since doing so would result in low scores, which could be interpreted as less hazardous compared to chemicals with higher scores based on data.

Lastly, Greenscreen assessments classified 6PPD and several possible alternatives as respiratory sensitizers based on dermal sensitization hazard, a respiratory sensitization structural alert (phenylenediamine alert from OECD QSAR Toolbox), and/or professional judgement (ToxServices, 2021a,b,c,f,g,h). Gradient listed ToxService's hazard assignments in the relevant hazard table (Table 5.1 Group A); however, Gradient did not score the endpoint based on respiratory sensitization assignment. Instead, a data gap score was assigned because there are very few recognized respiratory sensitizers relative to the large number of skin sensitizers (Kimber *et al.*, 2018; North *et al.*, 2016).

According to the United Kingdom government agency, Health and Safety Executive, there are only approximately 45 substances or chemical groups that are recognized respiratory sensitizers, mostly made up of enzymes, dusts, and low-molecule-weight chemicals (United Kingdom, Health and Safety Executive, 2021). Comparatively, there are many thousands of known or suspected dermal sensitizers (Kimber *et al.*, 2018). Additionally, many chemical allergens are exclusively dermal sensitizers (Kimber *et al.*, 2018). In other words, a substance's ability to elicit a dermal sensitization response is not a good predictor of its ability to elicit a respiratory sensitization response.

It is also important to recognize that the mechanisms in which dermal sensitization occurs (*i.e.*, adverse outcome pathway) is well understood, however, very little is known about the adverse outcome pathway leading to respiratory sensitization (North *et al.*, 2016). Respiratory sensitizers tend to induce a predominantly T helper cell type 2 (Th2) response involving IgE antibodies, whereas dermal sensitizers tend to induce a predominantly T helper cell type 1 (Th1) response (North *et al.*, 2016).

5.1.3 Hazard Scoring Results

5.1.3.1 Hazards of 6PPD and Possible Alternatives

Tables 5.1 and 5.3 summarize hazard scoring for the human health (Group A endpoints only), and environmental and physical evaluation parameters, respectively. The total hazard scores for each possible alternative are summarized in Table 5.8.

When interpreting the hazard scores, the higher the score, the greater the potential concern. However, while we quantitatively scored hazards of 6PPD and possible alternatives, it should be stressed that the hazard scores should be treated as approximations of hazards (*i.e.*, ballparks) because of the underlying uncertainties. A score of 100 would be considered less toxic than a score of 400, however, a score of 275 should be considered more or less the same compared to a score of 300.

6PPD and all 43 possible alternatives exhibited a lack of global warming or ozone depletion potential, contribution to smog formation, and flammability. That is, all 43 possible alternatives were essentially equal to 6PPD with respect to physical hazards and received scores of 0. Accordingly, total hazard scores were only affected by the human health and environmental hazard parameters. For example, 6PPD received a total hazard score of 275 based on scores of 125, 150, and 0 for human health, environmental, and physical hazards, respectively.

Human health and environmental hazard data were available for 19 of the 43 possible alternatives. Total hazard scores for these 19 alternatives ranged from 40 to 325. For a number of alternatives, no hazard data were available to develop a hazard score (*i.e.*, rambutan peel extract, amine functionalized lignin, DNPDA). The only possible alternative that received a total hazard score higher than 6PPD was 6QDI, a non-PPD possible alternative, with a score of 325. 6QDI was concluded to have many data gaps and relied on surrogate data from 6PPD for most hazard endpoints, and thus the higher hazard score for 6QDI was due to data gap penalties (*i.e.*, penalties of 25 each for data gaps for carcinogenicity and germ cell mutagenicity). Therefore, 6QDI may not necessarily need to be excluded from consideration as a possible alternative until relevant hazard endpoints are experimentally determined for 6QDI itself (rather than reliance on 6PPD as a surrogate).

Graphene (CAS 1034343-98-0), it is an engineered nanomaterial made completely from carbon. Not all graphenes are the same. The form of graphene evaluated in this report, due to positive performance, is a specialized form of graphene nanoplatelets. Even within this category of graphene, there could be differences (*e.g.*, size, number of layers, surface area, surface chemistry) that could contribute to differences in toxicity (Fadeel *et al.*, 2018; Achawi, *et al.*, 2021). Additionally, from a worker safety perspective, graphene nanomaterials must be handled with proper engineering controls and PPE to limit inhalation exposure (The Graphene Council and Barkan, 2023). The same increased level of engineering controls and PPE would be required for carbon nanotubes as well. The form of graphene (CAS 1034343-98-0) reported in the toxicology studies of the ECHA dossier (reported in Tables 5.1, 5.2, 5.3, and 5.8 of this report) consists of sets of graphene nanoplatelets (The Graphene Council and Barkan, 2023; ECHA, 2024). It is not known if the toxicology studies cited in the ECHA dossier would apply to the form of graphene under study in this AA based on size and shape. However, a patent on one form of this material, Prophene™ by Akron Polymer Solutions, described three commercial grades of Prophene™, which are various sizes and shapes of graphene without other modification¹⁷ (Paschall *et al.*, 2023). Note, the manufacturer of Prophene™, Akron Polymer Solutions, is not listed as one of the joint registrants of graphene in the ECHA dossier (ECHA, 2024).

No hazard information were identified for specialized carbon nanotube mixtures. While there are ECHA dossiers for various forms of carbon nanotubes (*i.e.*, branched and cross-linked multi-walled carbon nanotubes EC number 951-407-3, no CAS number; single wall carbon nanotubes EC number 943-098-9, no CAS number), the hazard information reported in these dossiers was not used to inform the hazards of specialized carbon nanotube mixtures. One example of specialized carbon nanotube mixture is MOLECULAR REBAR® carbon nanotubes. According to a patent by Molecular Rebar Design on mixtures

¹⁷ Grade PS50 with particle, sheet, or plate sizes of 50 nm to 5 microns; Grade PS100 with sheet or plate sizes 100 nm to 5 microns and increasing conductivity; and Grade PS150 with sheet or plate sizes of 150 nm to 10 microns.

of discrete carbon nanotubes (Peddini, 2021), the invention in question is dried liquid concentrates of carbon nanotubes and various rubber processing oils (*i.e.*, tris (2-ethylhexyl) trimellitate oil, TP-95, HyPrene 100 naphthenic oil, castor oil, carnauba wax, curing co-agents, and/or sebacates), in which carbon nanotubes may make up anywhere from 5 to 50% of the dried liquid concentrate. Furthermore, the carbon nanotubes described in the patent may be single, double, or multi-wall and they may or may not be oxidized on the interior and/or exterior surface. Additionally, according to a 2016 SDS from Molecular Rebar Design on MR 1420X DLC (naphthenic oil-MR dry liquid concentrate), this product is 15-20% of functionalized multiwalled carbon nanotubes (CAS # not yet assigned) and 75-85% of naphthenic oil CAS # 64742-52-5 (Molecular Rebar Design, 2015). It seems likely that the MOLECULAR REBAR[®] carbon nanotubes with the performance data (as described later in Table 5.13) is a version of the dried liquid concentrate described in the above-mentioned patent or SDS. Since carbon nanotubes may make up anywhere from 5 to 50% of the dried liquid concentrate with the remainder being potentially toxic rubber processing oils (*e.g.*, naphthenic oil), the ECHA dossier hazard profiles of pure carbon nanotubes were not used to inform the hazards of specialized carbon nanotube mixtures.

5.1.3.2 Group B Human Health Hazard Endpoints

Table 5.2 summarizes results for each possible alternative with respect to Group B human health hazard endpoints (*i.e.*, those that do not have corresponding GHS hazard endpoints such as ototoxicity or cardiovascular toxicity). As discussed, quantitative hazard scoring was not performed for Group B hazard endpoints and these endpoints are subsumed in the larger category of "systemic target organ toxicity" addressed in ECHA dossiers and GreenScreen assessments. Nevertheless, we qualitatively summarized Group B hazard information for each possible alternative in accordance with SCP guidelines.

Liver effects (*e.g.*, changes in liver organ weight and changes in liver functions) and hematological changes (*e.g.*, macrocytic anemia) were observed for 6PPD and some of the possible alternatives. However, the effects were either considered adaptive and/or not clinically significant by the respective ECHA dossier registrants (ECHA, 2024). Kidney effects, such as increased kidney organ weight and histopathological changes, were found for some of the possible alternatives; however, none of the respective ECHA dossier registrants considered the effects to classifiable either (ECHA, 2024). In addition, many of the possible alternatives and 6PPD are dermal sensitizers, but this information was already captured under Group A endpoints.

5.1.3.3 Salmonid Acute Toxicity – Parent Chemicals

Table 5.4 summarizes salmonid acute toxicity data (*i.e.*, LC₅₀) for the possible alternative parent chemical. As mentioned, we identified LC₅₀s for the parent chemicals themselves, and for their quinone products when appropriate and available. This section discusses results for the parent chemicals. For 6PPD, the lowest reported LC₅₀ in coho salmon was 250 µg/L in juveniles exposed for 24 hrs (Tian *et al.*, 2021), however, the lowest reported LC₅₀ in a salmonid was 140 µg/L in rainbow trout exposed for 96 hrs (Monsanto Co., 1977, as cited in the EcoTox database).

Eight of the 43 possible alternatives (as the parent chemicals) had LC₅₀ data available in a salmonid. The eight possible alternatives were four PPD derived chemicals (77PD, commercial DTPD, CCPD, and DAPD) and four non-PPD chemicals (6QDI, NBC, ethoxyquin, and N-Phenyl-1-naphthylamine). The lowest reported LC₅₀s of the nine possible alternatives ranged from 24 to >100,000 µg/L. The LC₅₀s were all determined in rainbow trout, with the exception of 77PD for which an LC₅₀ of 24 µg/L was determined in juvenile coho salmon exposed for 96 hrs (Chapelet *et al.*, 2023).

Two of the eight possible alternatives had LC₅₀s lower than 6PPD: 77PD and CCPD, for which LC₅₀s of 24 and 130 µg/L were reported after 96 hr exposures. As discussed, for 77PD the LC₅₀ data was reported in coho salmon (Chapelet *et al.*, 2023). For CCPD, the available LC₅₀ value was based on the LC₅₀ for 44PD as a surrogate (*i.e.*, 130 µg/L as reported by Dionne [1995 as cited in ECHA, 2024]). In contrast, the remaining six possible alternatives had LC₅₀s higher than 6PPD, ranging from 440 to >100,000 µg/L. Two of these six chemicals had LC₅₀s at least two orders of magnitude greater than that of 6PPD, the non-PPD chemicals ethoxyquin and NBC for which LC₅₀s of 18,000 and >100,000 µg/L, respectively, were reported in rainbow trout after 96 hr exposures.

Overall, among the 43 possible alternatives, LC₅₀ data in coho salmon was only available for 77PD. As mentioned, all other LC₅₀s were reported in rainbow trout, and although the majority were on the same order of magnitude as 6PPD, two non-PPD chemicals had LC₅₀s at least two orders of magnitude greater than that of 6PPD.

Ultimately, as discussed, changes to individual tire chemical components occur during manufacturing (Bebb, 1976). Thus, any potential toxicity hazards for individual tire components (to salmonids or otherwise) cannot be directly extrapolated to potential hazards or risk associated with their presence in a final vehicle tire product.

5.1.3.4 Salmonid Acute Toxicity – Quinone Products

Table 5.4 summarizes the lowest reported salmonid acute toxicity data (*i.e.*, LC₅₀) for 6PPDQ and quinone products of the potential PPD derived alternatives. For 6PPDQ, the lowest reported LC₅₀ in coho salmon was 0.041 µg/L as measured in juveniles (alevins) exposed for 24 hrs (Lo *et al.*, 2023). In addition, Nair *et al.* (2023) reported an LC₅₀ of 0.64 µg/L in juvenile rainbow trout exposed to 6PPDQ for 96 hrs. By contrast, LC₅₀ values reported in all other *Oncorhynchus* species were three to four orders of magnitude greater than in coho salmon, ranging from >1.3-2.4 µg/L in juvenile chum salmon (McIntyre *et al.*, 2021) to 67 µg/L in juvenile Chinook salmon (Lo *et al.*, 2023).

For potential PPD derived alternatives, LC₅₀ data for a quinone product was only available for five possible alternatives, 77PDQ, CPPDQ, DPPDQ, DTPDQ, and IPPDQ. Chapelet *et al.* (2023) reported an LC₅₀ > 226 µg/L in juvenile coho salmon exposed to 77PDQ for 96 hrs. In addition, Nair *et al.* (2023) reported LC₅₀s > 50 µg/L (the highest tested concentrations) in juvenile rainbow exposed to 77PDQ, CPPDQ, DPPDQ, DTPDQ, and IPPDQ for 96 hrs.

Overall, data regarding potential acute toxicity of the quinone products of the potential PPD derived alternatives is limited only to two studies involving 77PDQ (Chapelet *et al.*, 2023; Nair *et al.*, 2023), and CPPDQ, DPPDQ, DTPDQ, and IPPDQ (Nair *et al.*, 2023). These studies suggest there may be lower acute toxicity of 77PDQ, CPPDQ, DPPDQ, DTPDQ, and IPPDQ relative to 6PPDQ, however, these results will require validation by other laboratories and further studies. Hence, there is inadequate evidence to assess the potential acute toxicity hazard of quinone products of the potential PPD derived alternatives in salmonids.

5.1.3.5 USGS Predecisional Summary

Rubber samples containing 6PPD or one of three potential alternatives (77PD, CCPD, or DPPD) were used to address potential toxicity using cell Pacific cell-line toxicity assays established in Greer *et al.* (2023a). Studies conducted by USGS demonstrated the utility of cell-line-based approaches for initial screening of potential 6PPD alternatives. Ozonation of rubber containing 6PPD led to significant toxicity for coho cells in comparison with the Chinook salmon line. All rubber samples reacted with ozone resulting in production

of quinone transformation products. Representatives of all three classes of PPDs (77PD, CCPD, or DPPD) and their quinones showed differential toxicity relative to 6PPD, providing a preliminary indication that not all PPDs pose the same degree of hazard to coho as 6PPD.

Although preliminary, the Consortium believes this supports the consideration of other PPDs as part of the Stage 2 AA. As noted above, the USGS work is being conducted under a CRADA, and under the terms of that agreement, the results cannot be publicly released prior to publication by USGS. A confidential version of the results is being provided to DTSC separately as confidential business information. It is hoped that publication will allow for public release of the information during Stage 2.

5.1.3.6 Hazards of environmental degradation products

As shown in Table 5.10, ECHA dossier hazard data were available for 6PPDQ and four of the 11 potential hydrolysis products identified: 1) p-benzoquinone, 2) p-hydroquinone, 3) aniline, and 4) 1-methyl-propylamine. None of the potential breakdown products are listed on the EU PBT list. In addition, of the potential breakdown products, only aniline is present on the California Proposition 65. All of the identified breakdown products are present on the California TAC list, except for 6PPDQ and 1-methyl-propylamine.

All 4 of the hydrolysis breakdown products mentioned above are classified under GHS as Category 1 for acute aquatic toxicity, however, the classifications are not necessarily based on evidence in salmonids. Two of the breakdown products (p-hydroquinone and aniline) were also classified as Category 2 for carcinogenicity. A number of the breakdown products are also classified as skin sensitizers.

Overall, several of the possible PPD based alternatives (*i.e.*, 7PPD, 77PD, and 6QDI) have breakdown products in common with 6PPD (*i.e.*, aniline and p-benzoquinone) and thus have the potential for similar health hazards (*i.e.*, shaded orange in Table 5.10). For the majority of possible alternatives, breakdown products were not described in the ECHA dossiers and no conclusions about their potential hazards can be reached. This was notably the case for many of the possible non-PPD based alternatives (*e.g.*, NBC, DLTP, ethoxyquin, graphene). This constitutes an important source of uncertainty in the AA. Further research into the potential breakdown products of these possible alternatives is required.

It should also be noted that any chemical-hazards summarized above based on studies of pure chemical do not necessarily reflect actual hazards or risks associated with vehicle tires because the extent to which the possible alternative antidegradant will be released from the TRWP and be subject to breakdown is currently unknown.

5.2 Performance

As noted earlier, the Consortium members chose to include performance as a consideration in assessing alternatives in Stage 1. As discussed previously, demonstrating an alternative anti-degradant formulation is safe and effective in a tire is a lengthy process and it makes sense to focus the evaluation and available resources on the promising candidates as soon as practical. With 43 possible alternatives under consideration in Stage 1, evaluating what is known about their performance is a reasonable consideration for prioritization.

We investigated whether there were any available models to predict the behavior of antidegradants in tires (*e.g.*, migration, ozone protection). Several models of migration of chemicals in polymers were identified (*e.g.*, US EPA, 1990) but these were concerned with migration in simple polymers (*e.g.*, polypropylene) rather than the complex matrix of rubber with all of the various additives and layers. These were not found

to be useful for assessing migration of antidegradants through tire rubber. A recently published paper discusses modeling to predict the interactions of PPDs with ozone (Rossomme *et al.*, 2023). The authors' conclusions were that the ability to form a quinone was essential to the effectiveness of the PPD as an antiozonant. While useful for understanding PPD reaction chemistry, this model was not considered useful for evaluating non-PPD alternatives and has also not been verified using actual testing. Overall, we did not locate any models which could help inform the possible properties of an antidegradant in tires.

Lacking suitable models, we relied on the experience and knowledge of a working group of technical advisors, composed of 11 tire industry representatives with many decades of experience in tire development and manufacturing. In the working group member's combined experience, the best antiozonant has the para phenylene diamine structure (an aromatic ring with two nitrogens in the para positions) which allows for formation of a quinone. The value of the diamines in the para position has long been recognized by others (*e.g.*, Cox, 1958). In addition, antiozonants that have been successfully used in rubber in the past contain at least one nitrogen—for example, ethoxyquin. Nitrones (an N-oxide of an imine) are another class of chemicals that show some promise based on published studies. Prediction of reactivity against ozone is difficult, however, and members primarily relied on published screening level studies as described below. In terms of potential migration of antidegradants in rubber, factors working group members considered were the size and polarity of the molecule, the potential interaction with the filler (silica or carbon black), the polymer type, and the operating temperature (see Choi, 2001; PPG Industries *et al.*, 2020). Unfortunately, with multiple factors affecting migration, there are no clear "yes/no" criteria that can be specified.

To organize performance information available for the possible alternatives we considered three groupings: information available from studies published pre-2020 (the date the Tian *et al.* 2021 study was published on-line); data from testing on a select set of PPD alternatives conducted by Flexsys in conjunction with the USGS toxicity studies; and data from performance studies published post 2020. Each of these is discussed below.

5.2.1 Performance Data from Studies Pre-2020

Table 5.11 summarizes data for 29 possible alternatives that were published in patents, journal publications or other sources prior to 2020. This table lists the class of compound, the chemical name and CAS registry number, the results and interpretation of the screening-level performance test. The references for where the test information can be found are also included.

Preliminary performance was assigned to one of four categories:

- **Some promising ozone data (colored green).** These possible alternatives had positive data regarding ozone performance in screening level tests (*i.e.*, bench scale testing, not in finished tires).
- **Limited ozone data (also colored green).** These possible alternatives had some positive data for ozone performance in screening level tests but there were some concerns about the study, often a lack of an appropriate control or a lack of information about controls.
- **Insufficient data, no ozone data (colored yellow).** The chemical lacks any data related to performance as an antiozonant. Note that a chemical having positive data as an antioxidant does not indicate the chemical can perform as an antiozonant (Akrochem, 2010).

- **Poor ozone performance (colored red).** For these possible alternatives, the available data indicate the chemical does not perform as an antiozonant or performs poorly compared to 6PPD.

Those possible alternatives that have either some promising ozone data or limited ozone data are eligible to be included in the Stage 2 AA if they also have hazard information.

Note that in a few cases, literature sources indicated promising ozone performance, but Consortium members had actually tested the alternative and found it did not perform well against ozone. Consortium members conducted these tests in rubber compounds representative of those commonly used in tires and under laboratory conditions used to validate rubber compounds for use in tires, including critical aging tests that were not part of the literature sources. In such cases, the member experience was considered more definitive, and the materials were not considered to perform well against ozone.

In some cases, performance testing was pertained to static ozone resistance rather than dynamic ozone resistance. While not definitive, a chemical that is effective in static ozone testing may not perform well in a dynamic ozone test. Chemicals that have good dynamic ozone performance are assumed to have good static ozone performance.

Another potential concern is the migration potential of the alternative in tire rubber. As noted earlier, additives that migrate too slow or too fast relative to 6PPD will not provide stable ozone protection. However, no possible alternatives were eliminated solely based on concerns about migration potential.

It should also be noted that in these older studies, not all comparisons of performance were made against 6PPD. For example, some were compared to ethoxyquin or other PPDs, and in such cases, Consortium technical experts inferred whether this indicated similar or better performance compared to 6PPD was possible (generally we leaned towards including rather than excluding such compounds from further study). In addition, because the data comes from different sources, testing conditions may not be consistent across the chemicals evaluated, making interpretation challenging.

Table 5.11 Performance Data on Possible Alternatives From Sources Prior to 2020

Class of Compound	Chemicals	CAS	Performance Test Results	Interpretation of Performance Data	Reference
Phenylene Diamine	N-(1,4-dimethylpentyl)-N'-phenyl-p-phenylenediamine (7PPD)	3081-01-4	Comparable to 6PPD in Tier 2 type dynamic ozone test in SBR	Some promising ozone data	G. Wilder, US 3,839,275 "Preserving rubber with N-(1,4 dimethylamyl) - N'-para-phenylenediamine"
Phenylene Diamine	N-isopropyl-N'-phenyl-p-phenylenediamine (IPPD)	101-72-4	Comparable to 6PPD in Tier 2 type dynamic ozone test in SBR	Some promising ozone data	G. Wilder, US 3,839,275 "Preserving rubber with N-(1,4 dimethylamyl) - N'-para-phenylenediamine"
Phenylene Diamine	N-cyclohexyl-N'-phenyl-p-phenylenediamine (CPPD)	101-87-1	5% improvement over "commercial control" in Tier 2 type dynamic ozone test in NR; 17% improvement in SBR. Control not identified	Limited ozone data	US 3,511,805, M. Kosmin <i>et al.</i> , "Rubber preserved with alicyclicmethyl phenylenediamines"
Phenylene Diamine related	N-1,3-dimethylbutyl-N'-phenyl quinone diimine (6QDI)	52870-46-9	Shows approximately the same stabilizing effect as 6PPD in outdoor aging studies - Tier 2 testing but ozone level not provided	Poor ozone performance – Produces 6PPD when mixed with rubber	F. Ignatz-Hoover <i>et al.</i> , "Chemical additives migration in rubber" <i>Rubber Chemistry and Technology</i> (2003) 76 (3): 747–768
Dihydroquinoline	Polymerized 2,2,4-trimethyl-1,2-dihydroquinoline (TMQ)	26780-96-1	60% of activity of ethoxyquin in Tier 2 type testing	Poor ozone performance, not as active as ethoxyquin which is much less active than 6PPD	H. Kilbourne, "Chemical inhibition of ozone degradation of SBR", <i>Rubber Chemistry and Technology</i> (1959) 32 (4): 1155–1163
Diphenyl amine	4,4'-Dioctyldiphenylamine (DOPD)	101-67-7	15% better ozone resistance than ethoxyquin and 15% better than DTPD in a Tier 1 type test	Limited ozone data. However, migration rate is unsuitable based on expert judgment	H. W. Kilbourne, <i>et al.</i> "Chemical inhibition of ozone degradation of SBR", <i>Rubber Chemistry and Technology</i> , Vol. 32, p. 1155 (1959).
Phenylene diamine	N,N'-Ditolyl-p-phenylenediamine (Commercial DTPD)	68953-84-4	Equivalent to Ethoxyquin in a Tier 1 type test	Poor ozone performance based on 2023 Flexsys study (Table 5.12)	H. W. Kilbourne, <i>et al.</i> "Chemical inhibition of ozone degradation of SBR", <i>Rubber Chemistry and Technology</i> , Vol. 32, p. 1155 (1959).
Phenylene diamine	N,N'-Di-2-naphthyl-p-phenylenediamine (DNPDA)	93-46-9	No data - Listed only as an antioxidant in two separate articles. No ozone data.	Insufficient data, no ozone data	J. Amberlang, <i>et al.</i> , "Antioxidants and Antiozonants for General Purpose Elastomers" <i>Rubber Chemistry and Technology</i> (1963) 36 (5): 1497–1541.

Class of Compound	Chemicals	CAS	Performance Test Results	Interpretation of Performance Data	Reference
Metal dithiocarbamate	Nickel dibutyldithiocarbamate (NBC)	13927-77-0	Shown to be an antiozonant but cures too fast, which affects compound processability	Poor ozone performance	C. Pinazzi <i>et al.</i> , "Protection of natural rubber against atmospheric agents. I. The effects of nickel dibutyldithiocarbamate alone and in combination with protective agents. "Rubber Chemistry and Technology (1955) 28 (2): 438–456
Dihydroquinoline	Ethoxyquin	91-53-2	Early antiozonant used in tires but not as effective as CCPD	Poor ozone performance	H. W. Kilbourne, <i>et al.</i> "Chemical inhibition of ozone degradation of SBR", Rubber Chemistry and Technology, Vol. 32, p. 1155 (1959).
Sulfur compound	Dilauryl thiodipropionate	123-28-4	No Data. No reference to the material as an antiozonant	Insufficient data. No ozone data and not expected to be an antiozonant based on structural properties	Not available
Phenylene Diamine	4-N-(2,3-dimethylphenyl)-1-N-phenylbenzene-1,4-diamine- R1 and R2 are methyl	No CAS	No Data. No reference to the material as an antiozonant	Insufficient data, no ozone data	Not available
Phenylene Diamine	N' -Phenyl-N-Fluorenyl-Para-Phenylenediamine	No CAS	Shown to be equivalent to 77PD in SBR/NR in static ozone testing	Some promising ozone data	J. Hunt, US 3,625,913 "N'-Alkyl and N'-Aryl-N-Fluorenyl-p-phenylene=diamines as antiozonants in natural and synthetic diene rubbers"
Phenylene Diamine	N-(p-phenylthiomethylphenyl)-N'-(1,3-dimethylbutyl)-p-phenylenediamine	No CAS	Material provided good antiozonant protection but is expected to be too slow to migrate for long term protection based on expert judgment	Limited ozone data – but is expected to be too slow to migrate for long term protection based on expert judgment	J. Kuczkowski, US 4,124,565, "N,N' - DISUBSTITUTED-P-PHENYLENEDIAMINES"

Class of Compound	Chemicals	CAS	Performance Test Results	Interpretation of Performance Data	Reference
Phenylene Diamine	4-(2,5-dimethyl-1H-pyrrol-1-yl)-N-phenylaniline	No CAS	Original physical properties are equal to that of 6PPD and ozone testing shows excellent performance	Poor ozone performance – Although this specific patent shows positive data, several members have tested the molecule and found that the protection is insufficient	Youngju Kim (김영주), KR20090100673A, "Tire sidewall rubber composition" Patent
Phenylene Diamine	N,N - (ethane-1,2-diyl) bis (N-phenylbenzene-1 4-diamine [example chemical from patent])	No CAS	Tier 1 testing showed antiozonant activity is as good as 6PPD and Tier 2 testing showed better antifatigue activity	Limited ozone data – but molecular weight of compounds probably too high to effectively migrate based on expert judgment	M. Boone <i>et al.</i> , US Patent US 10,428,009 B2 METHODS OF MAKING COMPOUNDS AND MIXTURES HAVING ANTIDEGRADANT AND ANTIFATIGUE EFFICACY 2019
Phenylene Diamine (Kruger)	RU997, Irgazone 997 (Reaction product of N-phenyl-N'-(1,3-dimethylbutyl)-p-phenylenediamine with an alkyl glycidylthioether)	444992-04-5	No ozone data. Shown to migrate much slower than 6PPD	Insufficient data, no ozone data and shown to migrate much slower than 6PPD	R. H. Kruger, C. Boissiere, K. Klein-Hartwig & H. J. Kretzschmar (2005) "New phenylenediamine antiozonants for commodities based on natural and synthetic rubber", Food Additives and Contaminants, 22:10, 968-974
Dihydroquinoline	N,N-diethyl-2,2,4-trimethyl-1H-quinolin-6-amine (R= N(C ₂ H ₅) ₂)	No CAS	Shown to be a better antiozonant than ethoxyquin in Tier 2 lab tests	Some promising ozone data, but heavy staining may be an issue based on expert judgment	D. Beaver, <i>et al.</i> US Patent 2,713,047 6-diethylamino-1,2-dihydroquinolines
Hindered amine	N,N'-Dibenzyl-p-xylene-alpha,alpha'-diamine-	25790-41-4	Approximately 400% better than IPPD in time to cracking in NR and SBR compounds-Tier 2 testing but non-black compound	Some promising ozone data	E. Masatomo, <i>et al.</i> , US 3,634,316 "Sulfur vulcanizable natural and synthetic rubbery polymers containing xylene diamines as antiozonants"

Class of Compound	Chemicals	CAS	Performance Test Results	Interpretation of Performance Data	Reference
Triazine	2,4,6-tris-(N-1,4-dimethylpentyl-para-phenylenediamino)-1,3,5 triazine (Durazone 37 or TAPDT)	121246-28-4	Good solubility in NR but limited solubility in BR and SBR. Works as antiozonant at low levels in sidewall with phenolic resin as well as Durazone. No comparison to 6PPD. In EPDM sidewall ozone protection is equivalent to sample with no antiozonant. Several of the members tested this compound and it had poor performance.	Poor ozone performance	M. Pender, US 8,329,788 B2 "Tire having enhanced ozone resistance"
Phenyl naphthyl amines	N-Phenyl-1-naphthylamine	90-30-2	Listed as an antioxidant – poor ozone performance in chloroprene	Poor ozone performance	R. Murray, Factors Influencing the Ozone Resistance of Neoprene Vulcanizates under Flexure, RCT (1959) 32 (4):1117
Phenyl naphthyl amines	N-Phenyl-2-naphthylamine	135-88-6	Listed only as an antioxidant; no information regarding antiozonant potential	Insufficient data, no ozone data	Ambelang, J. C., <i>et al.</i> "Antioxidants and antiozonants for general purpose elastomers." Rubber Chemistry and Technology 36.5 (1963): 1497-1541.
Phenol	[2-Methyl-4,6-bis((octylthio)methyl)phenol (Irganox 1520)	110553-27-0	Samples containing very high levels of phenolic compound had good dynamic ozone performance in sidewall. At these levels, probably causes oxidation based on expert judgment.	Limited ozone data	D Dall'abaco, V. Formaggio, <i>et al.</i> , WO 2018/163041 A2, "TYRE FOR VEHICLE WHEELS "
Hydrazine	1,1' -Pentamethylenebis(2,2-Di-n- Butylhydrazine)	No CAS	Shown to be an antiozonant in dynamic testing of rubber but not compared to conventional antiozonants.	Limited ozone data	H. Stewart, US 3,157,616, Antiozonant rubber compositions containing alkylene bis-hydrazines
Nitrone + Phenolic AO	α - C-4- hydroxy- 3,5-dimethylphenyl - N-isopropyl and Lowinox WSP	Nitrone as a class, no CAS and Lowinox WSP - 77-62-3	Nitrone plus a phenolic antioxidant provided superior static ozone resistance to IPPD.	Some promising ozone data	G. Scott, UK Patent application 2137619 A-1984, "Nitrone compounds and stabilised rubber compositions containing them"

Class of Compound	Chemicals	CAS	Performance Test Results	Interpretation of Performance Data	Reference
Nitrone	α - C-4- Hydroxy- 3,5- dimethylphenyl-N-tert. butyl nitrone	No CAS	Compared to IPPD - reasonable ozone performance, some antifatigue activity, synergistic with phenolic antioxidants	Some promising ozone data	G. Scott, L. Nethsinghe, 1984 UK patent application 2137619A for "Nitrone compounds and stabilised rubber compositions containing them"
Gallate related	Octyl gallate	1034-01-1	Compound is an antioxidant. A similar compound, propyl gallate, is used in food applications and is shown to be active against ozone in protecting biological systems, but no data in tires or tire compounding was found.	Limited ozone data	Pauls, K.P. and Thompson, J.E. (1982) Effects of Cytokinins and Antioxidants on the Susceptibility of Membranes to Ozone Damage. <i>Plant and Cell Physiology</i> , 23, 821-832.
Gallate related	Nano calcium carbonate surface modified by gallic acid	No CAS	Using Irganox 1010 as the control, the compound showed improved static ozone resistance. However, 6PPD would be a better control, since Irganox 1010 is not an antiozonant. Additionally, no dynamic ozone data are available.	Some promising ozone data	Poompradub, Sirilux <i>et al.</i> "Improving oxidation stability and mechanical properties of natural rubber vulcanizates filled with calcium carbonate modified by gallic acid." <i>Polymer Bulletin</i> 66 (2011): 965-977.

Notes:

BR = Butadiene Rubber; CAS = Chemical Abstracts Service Number; EPDM = Ethylene Propylene Diene Monomer; NR = Natural Rubber; SBR = Styrene Butadiene Rubber.

5.2.2 Performance Testing at Flexsys of Possible Alternatives also Tested by USGS

As noted earlier, several PPDs (*i.e.*, CCPD, 77PD, DTPD, and 7PPD with 6PPD studied for comparison) were formulated into a model sidewall rubber compound, which was extracted and tested by USGS for potential toxicity using cell-based methods. To understand the potential performance of these formulated rubber materials, samples of the rubber were also tested for cure and dynamic ozone performance. Samples were exposed to ozone at concentrations of 10 pphm and 40 pphm for 24, 48, and 96 hours at 15% strain. Another series of samples were exposed to 40 pphm of ozone for 96 hours at 15% strain. Ozone performance was evaluated visually by estimating the size and number of cracks under the different conditions. The results of these tests are shown in Table 5.12. The same scoring system as described in Section 5.2.1 was used, although the yellow/insufficient data category did not apply. Two compounds showed adequate ozone performance; CCPD and 7PPD. Only 7PPD had performance equivalent to 6PPD; CCPD appeared to be less effective at higher ozone concentrations but showed at least some antiozonant activity that warranted further study. CCPD, DPPD and DTPD all failed the dynamic ozone testing (*e.g.*, had many more cracks than 6PPD). Table 5.12 also lists a few earlier studies from Table 5.11 that corroborated the results of the Flexsys testing.

Table 5.12 Performance Testing at Flexsys of Possible Alternative Also Tested by USGS

Chemical	CAS	Test Results	Interpretation of Performance Data	References
N,N'-Bis(1,4-dimethylpentyl)-p-phenylenediamine (77PD)	3081-14-9	Both samples failed in max ozone exposure where neither of two 6PPD samples failed	Poor ozone performance	Antiozonant study conducted at Flexsys in 2023
N,N'-diphenyl-p-phenylenediamine (DPPD)	74-31-7	Many more cracks than 6PPD at all ozone exposure conditions	Poor ozone performance	Antiozonant study conducted at Flexsys in 2023
N,N'-Dicyclohexyl-p-phenylenediamine (CCPD)	4175-38-6	Appearance was good at lower ozone exposure but at maximum ozone exposure only one of the two samples survived	Some promising ozone performance	Antiozonant study conducted at Flexsys in 2023
N,N'-Ditolyl-p-phenylenediamine (Commercial DTPD or DAPD)	68953-84-4	Both test samples failed at maximum ozone concentration.	Poor ozone performance	Antiozonant study conducted at Flexsys in 2023
N-(1,4-dimethylpentyl)-N'-phenyl-p-phenylenediamine (7PPD)	3081-01-4	Both test samples looked equivalent to 6PPD at all ozone levels.	Some promising ozone performance	Antiozonant study conducted at Flexsys in 2023

Notes:

CAS = Chemical Abstracts Service Number; USGS = United States Geological Survey.

5.2.3 Recent Performance Data at Other Laboratories (Post-2020)

Table 5.13 lists the performance results for a number of chemicals with published performance data since 2020. The same scoring system as described in Section 5.2.1 was used to evaluate the results. Several of the chemicals listed were tested with clear comparisons to 6PPD in terms of ozone protection, although again these may not involve tire compounds but other types of rubber where 6PPD is used (*e.g.*, nitrile

rubber). Nine chemicals were found to have at least some promising performance data indicating they would be appropriate for further study. The others were antioxidants but lacked data indicating antiozonant performance.

Table 5.13 Performance Data for Possible Alternative from 2020 to Jan 2024

Class of Compound	Chemical	CAS	Results from Non-standard Tests/Calculation	Interpretation of Performance Data	References
Phenylene Diamine	N,N - (ethane-1,2-diyl) bis (N-phenylbenzene-1 4-diamine [example chemical from patent])	No CAS	Material is more effective in ozone protection of liquid nitrile rubber than 6PPD	Some promising ozone data	M. Boone <i>et al.</i> , EP3394028, "Compounds with antidegradant and antifatigue efficacy and compositions including said compounds"
Phenylene Diamine	4-[4-(4-Methylpentan-2-ylamino)anilino] phenol	No CAS	Material has equivalent ozone protection to 6PPD in natural rubber/carbon black compounds	Some promising ozone data	X. Yang, WO 2022/146441, "Rubber composition with longer lasting antiozonation"
Inorganic	Specialized graphene	1034343-98-0	In sidewall compounds, it may be possible to reduce 6PPD if graphene is added to the rubber compound. However, Consortium members noted migration and diffusion across other tire components would need to be considered in assessing potential impacts.	Some promising ozone data	Doug Paschall <i>et al.</i> , "Tire Compounding with Prophene (sidewall)" Paper presented at Rubber Division Technical Meeting April 2022
Phenothiazine	N-(4-methylpentan-2-yl)-10H-phenothiazin-3-amine	No CAS	No ozone data but based on calculations the authors predict good ozone performance. It is an effective antioxidant	Some promising ozone data	C. Recker <i>et al.</i> , WO202206900 1A1, "Phenothiazine compound, its preparation and use in rubber blends and vehicle tires, as ageing protectant, antioxidant, antiozonant and colorant"

Class of Compound	Chemical	CAS	Results from Non-standard Tests/Calculation	Interpretation of Performance Data	References
Amine	7-(4-Methylpentan-2-ylamino)-2,3,4,10-tetrahydro-1H-acridin-9-one	No CAS	Compound has better oxidation onset temperature than 6PPD, but no ozone data.	Insufficient data, no ozone data	A. Jacob <i>et al.</i> , "Compound, rubber blend containing the compound, vehicle tire comprising the rubber blend in at least one component, process for producing the compound, and use of the compound as an ageing protectant and/or antiozonant and/or dye", WO 2023001338 A1
Amine	2-Cyclohexyl-N-(4-methylpentan-2-yl)-1H-indol-5-amine	No CAS	Compound has better oxidation onset temperature than 6PPD, but no ozone data.	Insufficient data, no ozone data	A. Jacob <i>et al.</i> , "Compound, rubber blend containing the compound, vehicle tire comprising the rubber blend in at least one component, process for producing the compound, and use of the compound as an ageing protectant and/or antiozonant and/or dye", WO 2023001339 A1
Amine	4-(1H-Indol-2-yl)-N-(4-methylpentan-2-yl)aniline	No CAS	Compound has better oxidation onset temperature than 6PPD, but no ozone data.	Insufficient data, no ozone data	A. Jacob <i>et al.</i> , "Compound, rubber mixture containing the compound, vehicle tire which has at least one component comprising the rubber mixture, process for preparing the compound, and use of the compound as an aging protection agent and/or antiozonant and/or colorant", WO2023001340A1

Class of Compound	Chemical	CAS	Results from Non-standard Tests/Calculation	Interpretation of Performance Data	References
Phenylene diamine	Representative example from class (4-((4-(dimethylamino)phenyl)amino)phenol)	6358-22-1	Good static and dynamic ozone resistance in natural rubber black compound.	Some promising ozone data	X. Yang and J. Arnold, World Patent WO 2022/146441 A1 "Rubber Composition with Longer Lasting Antiozonation"
Polymeric amine functionalized lignin	Amine functionalized lignin	No CAS	Ozone testing was static, but comparable to 6PPD. Fatigue was similar to 6PPD. Since there is no blooming or reservoir, it is unlikely to provide long term protection	Some promising ozone data	J. Chung, U. Hwang, J. Kim, N. Kim, J. Nam, J. Jung, S. Kim, J. Cho, B. Lee, I. Park, J. Suhr, D. Nam, "Amine-functionalized lignin as an eco-friendly antioxidant for rubber compounds" ACS Sustainable Chemistry and Engineering 2023, 11 (6), 2303-2313
Gallate related	Rambutan peel extract	No CAS	Ozone testing showed comparable crack resistance to 6PPD	Some promising ozone data	Sukatta U, Rugthaworn P, Seangyen W, Tantaterdtam R, Smitthipong W, Chollakup R. Prospects for rambutan peel extract as natural antioxidant on the aging properties of vulcanized natural rubber. SPE Polymers. 2021;2:199-209. https://doi.org/10.1002/pls2.10042

Class of Compound	Chemical	CAS	Results from Non-standard Tests/Calculation	Interpretation of Performance Data	References
Phenylene diamine	N-1-Methylheptyl-N'-phenyl-p-phenylenediamine (8PPD or UOP 688)	15233-47-3	No data but expected to perform similar to 7PPD. Reported as a commercial antiozonant in the 1970s.	Limited ozone data	A. Jacob, US Patent Application 20230312874 for: "Compound, rubber mixture containing the compound, vehicle tire which has at least one component comprising the rubber mixture, method for producing the compound, and use of the compound as an aging protection agent and/or antioxidant agent and/or antiozonant and/or dye"
Nanoscale carbon material	Specialized carbon nanotube mixture	No CAS	Preliminary static ozone data is positive. It is not known if the compound would work alone as an antiozonant in dynamic ozone tests over a prolonged period. May need to be used in conjunction with another antidegradant. Additionally, material is highly reinforcing and difficult to mix. Major adjustments required for use.	Some promising ozone data	Molecular Rebar Design, May 22, 2024. "Successful results: Molecular Rebar Rubber Compounds Eliminating Need for 6PPD"

Notes:

CAS = Chemical Abstracts Service Number; SPE = Society of Plastics Engineers.

5.2.4 Future Testing Required

In the sections above, possible alternatives were identified that produced positive results in initial screening tests of ozone protection. It must be stressed that such tests are the first step in evaluating an alternative and they cannot be assumed to indicate actual effectiveness in a manufactured tire. To place the above results in context, we provide below a discussion of further performance testing that may be required prior to selecting a final alternative.

As mentioned in Section 3.4, all new passenger, light truck, truck and bus, trailer, and motorcycle tires sold in the United States must meet rigorous FMVSS (49 CFR Part 571). However, well before a possible alternative is incorporated into a tire, it must pass many feasibility tests to assess its suitability in a tire.

To assess the feasibility of any new chemical or material in tires, chemical manufacturers, researchers, and tire manufacturers may conduct the Tier 1a screening tests listed in Table 5.14 below. Tire manufacturers may conduct the Tier 1b laboratory-scale screening tests noted in Table 5.14 to evaluate the performance of the candidate chemicals or materials in green (non-cured) and cured rubber compounds. A primary purpose of the Tier 1 laboratory-scale tests is to disqualify chemicals or materials that do not perform as required. Once a candidate chemical or material achieves the required outcome in laboratory tests, a tire manufacturer then typically conducts pilot, or intermediate-scale (Tier 2) tests, involving tens to a few hundred kilograms of rubber compounds. A limited number of test tires may be produced using rubber compounds from the pilot-scale mixing tests and used for preliminary tire testing before resources are committed to conducting manufacturing-scale tests. Tier 2 tire compound testing usually requires several iterations to determine if acceptable properties can be obtained. Only once the material achieves the required outcome in Tier 2 tests, will the new material be evaluated in factory-scale processing trials, followed by tire builds, and finally long-term tire testing (Tier 3). These factory-scale tests are also used as a means to ensure consistent batch-to-batch properties of the rubber compounds, consistent industrial performance, and consistent in-tire performance.

In order to assess the performance feasibility of 6PPD alternatives in tires, Consortium members would take the same approach as described above. Table 5.14 below is a non-exhaustive listing of tests which may be conducted by chemical manufacturers, researchers, and/or tire producers to screen and ultimately test candidate alternative antidegradants. Tire manufacturers will rely on properties listed in the Tier 1b, 2, and 3 sections of Table 5.14 and may also conduct additional testing, beyond what is listed in this table.

All tires sold in the US are required to comply with the requirements in all applicable FMVSS, so no possible alternatives would advance on to long-term tire testing if Tier 1 and 2 testing results are not favorable. In addition, regardless of how well a 6PPD alternative performs in laboratory-scale and pilot-scale testing, the performance of the alternative in a long-term, field, tire testing is the deciding factor regarding the suitability of the material for safe commercial scale use.

In addition to performance testing, toxicity testing would also be required to demonstrate that a selected alternative does not cause toxicity to coho salmon (or potentially other salmon species) and to support chemical registration in various jurisdictions if such registration has not already been established.

Table 5.14 Non-Exhaustive List of Performance Testing for Candidate Antidegradant Chemicals or Materials in Tires

Tiered Approach		Test Legally Required in the US?	Properties Tested	Description	Test Method
Tier 1a	Laboratory Testing for Screening of Chemicals for Inherent Antiozonant Activity	No. Chemical manufacturers, researchers, and/or Consortium members may utilize Tier 1a tests to screen chemicals before moving on to Tier 1b tests.	Reaction with Ozone	Test measures the ability to protect polymer in solution. Quick and easy to run.	Layer, R. 1966. <i>Rubber Chemistry and Technology</i> 39(5):1584-1592
			Migration	Tests ability of chemical to migrate to the surface	Ignatz-Hoover, F. 2003. <i>Rubber Chemistry and Technology</i> 76(3):747-768 (and references therein)
Tier 1b	Laboratory (Small-Scale) Testing of Candidate Alternatives in Green and Cured Rubber Compounds	No. Consortium members utilize Tier 1b tests to screen chemicals before moving on to Tier 2 tests.	Viscosity (Processability)	Rheological properties of green (uncured) rubber compounds	ASTM D6146
			Cure/Reversion	Speed of vulcanization / indicator of potential for reversion in a cured compound	ASTM D5289 ASTM D2084
			Stress-Strain	Mechanical properties of compound	ASTM D412-A
			Tear Strength	Ability to remove tire from mold	Die B Tear Strength: ASTM D624
			Ozone: Static	Ozone resistance	ASTM D1149
			Ozone: Dynamic	Ozone resistance in service	ASTM D1149
			Ozone: Intermittent Dynamic/Static	Best overall test – Reflects all states of tire	ISO 1431-2012
			Fatigue to failure	Effect of flexing on compound life	ASTM D4482
			Wire adhesion testing (belt and body ply compounds)	Adhesion of steel reinforcement to rubber compounds	ASTM D2229
			Viscoelastic Properties	Tire performance predictors (traction & rolling resistance)	ASTM D5992

Tiered Approach		Legally Required to Pass in the US?	Properties Tested	Description	Testing Method	
Tier 2	Pilot-Scale Testing of Tire Compounds ¹ / Testing of Tires ²	No, but all manufacturers would need alternatives to demonstrate acceptable performance for all Tier 2 tests before moving onto to Tier 3 tests.	Initial evaluation of performance in industrial processes			
			Green & cured properties listed in Tier 1b			
			Wear Test (Tread Compounds)	Tread lifetime	Various: LAT 100, ISO 23233:2009; DIN ASTM D5963	
			Aged Endurance	Machine (drum) testing of tires	Methods set by individual Consortium members	
			High Speed Performance			SAE J1561
			Rolling Resistance			ISO 17025, 28580 SAE J1269, J1270, J2452
			Traction	Wet & dry traction (and perhaps snow for some applications)	Wet: ASTM F1649 Dry: ASTM F1650 Snow: ASTM F2493	
Tier 3	Manufacturing-Scale Testing of Tire Compounds ¹ / Testing of Tires ²	Yes	Processability	Consistency of handling of rubber compound on tire plant equipment	ASTM D1646	
			All green & cured rubber properties listed in Tier 1b.			
			Endurance	Evaluates tire's ability to perform over extended lab test, including low pressure conditions for FMVSS No. 139 tires	FMVSS 119/139 (tire type dependent)	
			High Speed Performance	Evaluates tire performance at high test speeds	FMVSS 119/139 (tire type dependent)	
			Bead Unseat	Evaluates tire resistance to force applied to sidewall under lab test conditions	FMVSS 139 (passenger/some LT)	
			Tire Strength	Evaluates performance of tire under plunger force applied to tread	FMVSS 119/139	

Tiered Approach		Legally Required to Pass in the US?	Properties Tested	Description	Testing Method
			Field performance	Long-term evaluation of tires on vehicles in a limited-scale, monitored, evaluation	Methods set by individual Consortium members

Notes:

6PPD = N-(1,3-Dimethylbutyl)-N'-phenyl-p-phenylenediamine; ASTM = American Society for Testing and Materials; FMVSS = Federal Motor Vehicle Safety Standards; ISO = International Organization for Standardization; US = United States; UTQGS = Uniform Tire Quality Grading Standards.

Sources: FMVSS 139 (<https://www.nhtsa.gov/sites/nhtsa.gov/files/tp-139-02.pdf>); UTQG (<https://www.ecfr.gov/current/title-49/subtitle-B/chapter-V/part-575/subpart-B/section-575.104>).

(1) Several of these tests are run on both the original sample and aged samples. There are a number of additional tests that are run on specific compounds. For example, ply-to-ply adhesion strength, wire adhesion to wirecoat compound (wire coverage and pullout force), filler performance on cure (agglomeration), and other tests.

(2) In addition to these tests, each individual company will run proprietary tests to evaluate noise, handling, wet performance, wear, cut/chip resistance, performance on ice, performance in snow, and ride comfort.

5.3 Relative Exposure Potential

5.3.1 Relative Exposure Potential of 6PPD and Possible Alternatives

For Table 5.9, we consulted experimental, modelled, and estimated data from a variety of sources, including study reports, mainly from ECHA REACH dossiers (ECHA, 2024) and US EPA's EPI Suite software (US EPA, 2019a). In Table 5.9, all experimental values are bolded to differentiate between experimental and modeled or estimated data. Similar to the hazard information, there are many data gaps regarding information on the physical-chemical properties of the possible alternatives' ingredients, particularly those that do not have ECHA REACH dossiers or are polymers, mixtures, or unknown or variable compositions, complex reaction products, and biological materials (UVCBs). Polymers, mixtures and UVCBs cannot be modeled in programs such as EPI Suite, due to a lack of a Simplified Molecular Input Line Entry System (SMILES) and a reliable underlying dataset. In addition, Gradient did not color-code this table, because no color-coding was provided by the various data sources and because it would be difficult to assign relative preferences for many of the relevant factors.

Many of the physical-chemical parameters are not materially relevant given how vehicle tires are used (*e.g.*, melting and boiling point are not relevant because the TRWP are not likely to reach temperatures in which the chemical state of 6PPD in the tire will be altered, and volatility is addressed *via* the vapor pressure parameter). For those endpoints that would be materially relevant for vehicle tires (*e.g.*, log octanol-water partition coefficient [K_{ow}], log organic carbon partition coefficient [K_{oc}], vapor pressure, and water solubility), we used the following criteria from US EPA's "Interpretive Assistance Document for Assessment of Discrete Organic Chemicals" (US EPA, 2013) for the evaluation of possible alternatives' exposure potential in air, water, soil, sediment, and groundwater *via* soil and sediment:

- **Vapor Pressure – Estimated by MPBPWIN:**
 - $\geq 10^{-4}$ = Chemical mostly in the vapor (gas) phase.
 - 10^{-5} to 10^{-7} = Chemical in the vapor and particulate phase.
 - $\leq 10^{-8}$ = Chemical mostly in the solid phase.
 - For chemicals with a vapor pressure $< 10^{-6}$, there is low concern for inhalation exposure.
- **Water Solubility (mg/L) – Estimated by WSKOWWIN:**
 - $> 10,000$ = Very soluble.
 - $> 1,000$ - $10,000$ = Soluble.
 - > 100 - $1,000$ = Moderate solubility.
 - > 0.1 - 100 = Slightly soluble.
 - < 0.1 = Negligible solubility.
- **Log K_{ow} – Estimated by KOWWIN:**
 - < 1 = Highly soluble in water (hydrophilic).
 - > 4 = Not very soluble in water (hydrophobic).
 - > 8 = Not readily bioavailable.

- >10 = Not bioavailable – difficult to measure experimentally.
- **Log K_{oc} – Estimated by PCKOCWIN:**
 - >4.5 = Very strong sorption to soil and sediment; negligible migration potential to groundwater.
 - 3.5-4.4 = Strong sorption to soil and sediment; negligible to slow migration potential to groundwater.
 - 2.5-3.4 = Moderate sorption to soil and sediment; slow migration potential to groundwater.
 - 1.5-2.4 = Low sorption to soil and sediment; moderate migration potential to groundwater.
 - <1.5 = Negligible sorption to soil and sediment; rapid migration potential to groundwater.

The physical-chemical data in Table 5.9 were examined in the context of the abovementioned US EPA criteria to look for differences among the possible alternatives. The results of the comparison are included in Table 5.9.

For 6PPD, low exposure potential *via* air is expected (based on a value of 4.93×10^{-6} mm Hg at 25°C). Low exposure potential *via* air is also expected for the majority of alternatives. Twenty-four chemicals had vapor pressures at least one order of magnitude lower than 6PPD (ranging from 1.57×10^{-19} to 5.47×10^{-7} mm Hg at 25°C), and eight chemicals were on the same order of magnitude as 6PPD (ranging from 1.24×10^{-6} to 8.22×10^{-6} mm Hg at 25°C). No vapor pressure was found for graphene. However, vapor pressure for graphene would be negligible since graphene is an inorganic with melting point above 4,000°C. In contrast, two of the 11 remaining chemicals may have some air exposure potential due to vapor pressures greater than 0.0001 mm Hg (the non-PPD alternatives NBC and ethoxyquin).

Regarding exposure potential *via* water for 6PPD, we identified a water solubility of 2.83 mg/L at 25°C and log K_{ow} of 4.68 at 20°C, suggesting that 6PPD is relatively insoluble in water and hydrophobic. The majority of possible alternatives are expected to have similar exposure potential *via* water. In addition, 34 of the 43 possible alternatives had log K_{ow} values greater than 3.5 (ranging from 3.66 to 11.9), suggesting they are relatively hydrophobic. Based on water solubility greater than 100 mg/L, only two possible alternatives, the possible non-PPD alternatives 1,1'-pentamethylenebis(2,2-di-n-butylhydrazine) and representative example from class (4-((4-(dimethylamino)phenyl)amino)phenol), are expected to be soluble or moderately soluble in water, respectively. However, all of the possible alternatives have log K_{ow} values greater than 1, suggesting that none of the alternatives may be considered hydrophilic. For example, 1,1'-pentamethylenebis(2,2-di-n-butylhydrazine) and representative example from class (4-((4-(dimethylamino)phenyl)amino)phenol) have log K_{ow} values of 2.64 and 5.57, respectively.

Regarding exposure potential *via* sediment for 6PPD, we identified a log K_{oc} of 4.363 suggesting that the candidate chemical may sorb strongly to soil and sediment and have negligible to slow potential for migration to groundwater. All alternatives had log K_{oc} ≥ 3 (ranging from 2.992 to 11.407), suggesting at least moderate potential to sorb to soil and sediment and slow migration potential to groundwater. No log K_{oc} was identified for graphene.

Some of the possible alternatives have substantially less water solubility than 6PPD (*e.g.*, DOPD, DLTP, RU997, and TAPDT) which could affect their environmental partitioning. Similarly, some have

substantially higher log K_{ow} values (an indication of partitioning into organic materials) than 6PPD (e.g., DLTP, Ru997/Irgazone 997 blend, TAPDT, and DOPD) which again could result in different environmental behavior. Some also have substantially different vapor pressures (some higher, some lower) which could affect workplace exposures. While this evaluation provided some insight into the ingredient-level exposure potential of the possible alternatives, ideally, we would compare the product-level exposure data, because the ingredients are meant to react and create a structure that is distinctly different from the individual ingredients. Unfortunately, no product-level exposure information is available at this time for any alternative.

5.3.2 Relative Exposure Potential of Potential Breakdown Products

As summarized in Table 5.10, 6PPDQ did not have an ECHA dossier and therefore did not report information regarding physical-chemical parameters of interest (*i.e.*, vapor pressure, water solubility, log K_{ow} , and log K_{oc}). Data regarding relevant physical-chemical parameters was available for seven of the 11 potential hydrolysis products (4-hydroxydiphenylamine, 1,3-dimethylbutylamine, p-benzoquinone, p-hydroquinone, aniline, 6QDI, and 1-methyl-propylamine). In general, these hydrolysis products may have some exposure potential *via* air and water, but low to moderate exposure potential *via* sediment.

Briefly, based on reported vapor pressures ranging from 7.5×10^{-6} to 0.305 mm Hg at 25°C, the hydrolysis products may have potential to be in the vapor phase and therefore may exhibit some exposure potential *via* air. Based on water solubility ranging from 7.9 to 7,200 mg/L, the hydrolysis products are generally expected to be slightly soluble to soluble in water. Only one of the hydrolysis products, the non-PPD 6QDI (a reported hydrolysis product of 6PPD), has a log K_{ow} greater than 4, suggesting relative hydrophobicity. In contrast, log K_{ow} of the other hydrolysis products range from 0.1 to 2.82, suggesting relative hydrophilicity. Finally, available log K_{oc} values for the hydrolysis products range from 1.57 to 2.6, suggesting low to moderate potential to sorb to soil and sediment, and slow to moderate migration potential to groundwater.

As discussed, while this evaluation provided some insight into the exposure potential of the breakdown products (*via* hydrolysis only) of possible alternatives that could be used as ingredients, ideally, we would compare breakdown products resulting from completed vehicle tire. No such exposure information is available at this time.

6 Conclusions of Stage 1 AA

6.1 Selecting Possible Alternatives to the Priority Product

Using the data gathered related to hazard exposure potential and performance, as discussed in Section 5, we then used the information in aggregate to draw conclusions about whether there were possible alternatives that should be considered in greater depth in a Stage 2 AA. There are various methods for selecting alternatives in an AA, ranging from purely qualitative and narrative approaches to sophisticated approaches such as multi-criteria decision analysis (MCDA) (Beaudrie *et al.*, 2020). Although we used a modified CSI approach to score toxicological hazards (with the exception of group B endpoints and salmonid toxicity), we were unable to develop quantitative scores for relative exposure potential or performance. Relative exposure potential was scored as better, similar, or worse than 6PPD. Performance was scored as whether the available information suggested a chemical might be suitable for further testing (*i.e.*, the data were suggestive of ozone reactivity but not informative of performance in a tire), had insufficient data to understand potential performance, or had data indicating poor performance. Thus, our approach was both quantitative (with the modified CSI scoring) and qualitative (for group B endpoints, salmonid toxicity, relative exposure potential and performance). Given this combination of quantitative and qualitative information, a flexible narrative approach is the best method for considering the data and reaching a conclusion about a possible alternative's merits.

In our narrative analysis we considered the following:

- Whether the hazard score was preferable, similar, or less preferable than 6PPD. Preferable and less preferable were based on a chemical being 30 percent above or below the 6PPD CSI scores for human health, environmental hazards, and physical hazards. While this information was considered, we did not eliminate any possible alternatives from Stage 2 based on hazard score *alone*, except in the case of complete hazard data gaps. When there was absolutely no hazard data available from the sources we considered, we judged the barriers to obtaining regulatory approval for the chemical would be too high and that moving forward without such data could possibly lead to a regrettable substitution.
- Whether any of the Group B endpoints suggested a form of toxicity not found for 6PPD or more substantial than that reported for 6PPD. We found no convincing evidence of such a difference, so this did not figure in the consideration.
- Whether data on toxicity to salmonids suggested lower toxicity than 6PPD and 6PPDQ. If an alternative had an LC₅₀ value more than one order of magnitude greater or lower than that reported for 6PPD and 6PPDQ – that was considered to be an important difference.
- Whether key data on exposure potential (*e.g.*, water solubility, vapor pressure, log K_{ow}, log K_{oc}) suggested differential migration in the environment and therefore different exposure potential relative to 6PPD. This was a difficult consideration to assess because various potential exposure pathways are being considered, and a factor that was beneficial for one pathway could be detrimental to another (*e.g.*, reduced water solubility could mean less exposure *via* water but more exposure *via* sediment). While this information was also considered, we did not eliminate possible alternatives from Stage 2 based on relative exposure potential *alone*.

- Whether preliminary data from bench scale tests regarding performance of the chemical as an antidegradant (particularly protection against ozone) suggested the possible alternative to be eligible for inclusion in Stage 2 AA. In addition, when there were concerns about potential for migration in tire rubber, these were noted but were not a factor in ruling out a possible alternative.

Regarding the relevant factors listed in Tables 4.4 and 4.5 and rated as "yes" or "potentially" as to their relevance for reaching an AA conclusion, most of the health hazard and environmental hazard (*e.g.*, aquatic toxicity, effects on aquatic organisms, persistence) factors are already covered by the CSI hazard scoring approach and the salmonid data described above. Among the Group B human health endpoints, there were no differences among alternatives (considering data gaps and study limitations) that appeared to constitute a "material" difference. Among the environmental fate/physical and chemical properties described in Table 4.4, the most critical (*e.g.*, water solubility, vapor pressure, lipid, and carbon solubility) are also covered in the decision-making process, as noted above. Other potentially relevant factors that are physical/chemical properties – such as molecular weight, boiling point, *etc.* – are related to these critical properties (*e.g.*, chemicals with high boiling points also have high vapor pressures) and so were not explicitly considered separately. Flash point, a factor added by the Consortium members due to concerns about safety during manufacture, was judged to be only potentially relevant for those alternatives that lacked GHS flammability classification (which is based on flashpoint). A number of life cycle stages (*e.g.*, use, waste generation and management, reuse/recycling, and end-of-life) were all scored as potentially relevant; more information about how the possible alternatives would affect these stages of the tire life cycle is needed in order to determine their potential impact.

Overall, the decision to retain a possible alternative for further consideration in Stage 2 was based primarily on a chemical having sufficient hazard data and if the possible alternative also had some promising or limited ozone performance data. Whether a chemical and its quinone transformation product had lower toxicity to salmonids was considered but was not a determinant for exclusion because data exist for so few chemicals. As noted above, relative exposure potential also appeared to not be clearly differentiated among alternatives. Some alternatives appeared more likely to migrate through certain environmental media more than others, but whether this results in a significant difference in risk to all receptors of concern was not clear.

6.2 Possible Alternatives to Priority Product to Consider in Stage 2

The results of the Stage 1 AA are summarized in Table 5.15 where existing data on hazard, relative exposure potential, and performance are shown for each possible alternative. It should be noted that performance data are limited to simple screens where such information is available. As detailed earlier in this Stage 1 AA report, much more extensive testing would be required before any actual alternative could be implemented.

Of the 43 possible alternatives considered in the Stage 1 AA, only a few had both hazard data and screening level performance data suggesting a potential to perform in tires as an antiozonant. The chemicals that met these criteria and would be further evaluated in Stage 2 are the following:

7PPD. This chemical has similar overall hazard score relative to 6PPD. It also has similar exposure potential. In screening level tests conducted by Flexsys it showed effective performance against ozone.

IPPD. This chemical has similar overall hazard score relative to 6PPD (slightly lower environmental hazard). Results of one study suggest the quinone metabolite is less toxic than

6PPDQ in rainbow trout. It is slightly more likely to migrate to water. In a screening level test reported in a 1970 patent, IPPD showed effective performance against ozone; however, more data are required about its long-term protection ability in tires.

77PD. This chemical has somewhat lower hazard scores than 6PPD. One study (Chapelet *et al.*, 2023) showed that while the parent chemical is somewhat more toxic to coho salmon (and other species) than 6PPD, the quinone metabolite is far less toxic to coho salmon than 6PPDQ, meaning that the overall impact on coho would likely be less. In addition, based on limited data from cell-based studies conducted by USGS, it appears that the parent chemical and its corresponding quinone may have a slightly improved toxicity profile for coho salmon relative to 6PPD, a finding that requires confirmation. 77PD has similar exposure potential relative to 6PPD. In screening level tests conducted by Flexsys it showed effective performance against ozone.

CCPD. This chemical has similar overall hazard to 6PPD and, based on limited data from cell-based studies conducted by USGS, it appears that the parent chemical and its corresponding quinone may have an improved toxicity profile for coho salmon relative to 6PPD; a finding that requires confirmation. It also has similar exposure potential. In screening level tests conducted by Flexsys it showed effective performance against ozone.

Specialized graphene. Graphene nanoplatelets (as discussed previously) are graphene-based materials with a surface area not greater than 180 m²/g, and a carbon content greater than 99% and an oxygen content less than 1%. The lateral particle size of these materials is between 100 nm and 5 µm. This particular material has superior hazard scores relative to 6PPD, although, as noted in Section 5.1.3.1, potential differences in the structure of the graphene tested in performance studies and the form of graphene reported in ECHA dossiers may be important to consider in Stage 2 since differences in size, number of layers, surface area, and/or surface chemistry could contribute to differences in exposure and toxicity (Fadeel *et al.*, 2018; Achawi, *et al.*, 2021). There are no data indicating its toxicity to salmon and while potential toxicity seems unlikely, it should be verified. Graphene is likely to remain part of the rubber matrix, and it is non-volatile and non-water soluble. Since graphene does not migrate in rubber, 6PPD or another antiozonant will need to be used in conjunction with graphene in tires. However, use of graphene could constitute a potential method for reducing 6PPD concentrations without compromising important criteria such as the potential for rubber rework during the tire manufacturing process.

Octyl gallate. Octyl gallate can be synthesized from natural sources and/or fossil fuel-based sources. It has a lower hazard score and similar relative exposure potential compared to 6PPD. While no ozone performance was found in tire or tire compounding tests, a similar chemical, propyl gallate has been shown to be an antiozonant in biological systems.

Irganox 1520. Irganox 1520 is a phenolic antioxidant. It has a substantially lower hazard score compared to 6PPD. It is less water soluble, has lower vapor pressure and is more carbon- and fat-soluble compared to 6PPD. It has limited but promising performance data with respect to ozone protection.

6.3 Alternatives to be Eliminated from Further Consideration

As shown in Table 5.15, 36 of the 43 alternatives evaluated were eliminated from further consideration in Stage 2. Some alternatives were eliminated because they have so many data gaps in terms of toxicological hazard that they could not be confidently evaluated. This was the case for the following 24 alternatives:

- N-cyclohexyl-N'-phenyl-p-phenylenediamine (CPPD)
- 4,4'-Dioctyldiphenylamine (DOPD)
- N,N'-Di-2-naphthyl-p-phenylenediamine (DNPDA)
- N' -Phenyl-N-Fluorenyl-Para-Phenylenediamine
- N-(p-phenylthiomethylphenyl)-N'-(1,3-dimethylbutyl)-p-phenylenediamine
- 4-(2,5-dimethyl-1H-pyrrol-1-yl)-N-phenylaniline
- N,N - (ethane-1,2-diyl) bis (N-phenylbenzene-1,4-diamine [example chemical from patent])
- 4-N-(2,3-dimethylphenyl)-1-N-phenylbenzene-1,4-diamine- R1 and R2 are methyl
- 4-[4-(4-Methylpentan-2-ylamino)anilino]phenol
- Representative example from class (4-((4-(dimethylamino)phenyl)amino)phenol)
- N,N-diethyl-2,2,4-trimethyl-1H-quinolin-6-amine (R= N(C₂H₅)₂)
- N,N'-Dibenzyl-p-xylene-alpha,alpha'-diamine-
- 1,1' -Pentamethylenebis(2,2-Di-n- Butylhydrazine)
- α - C-4- hydroxy- 3,5- dimethylphenyl- N-isopropyl combined with 2,2'-Methylenebis[6-(1-methylcyclohexyl)-p-cresol]
- N-(4-methylpentan-2-yl)-10H-phenothiazin-3-amine
- 7-(4-methylpentan-2-ylamino)-2,3,4,10-tetrahydro-1H-acridin-9-one
- 2-cyclohexyl-N-(4-methylpentan-2-yl)-1H-indol-5-amine
- 4-(1H-indol-2-yl)-N-(4-methylpentan-2-yl)aniline
- α - C-4- Hydroxy- 3,5- dimethylphenyl-N-tert. butyl nitrene
- Amine functionalized lignin
- Rambutan peel extract
- N-1-Methylheptyl-N'-phenyl-p-phenylenediamine (8PPD or UOP 688)
- Nano calcium carbonate surface modified by gallic acid
- Specialized carbon nanotube mixture

As part of the Stage 2 AA process, we will revisit these to determine if reliable toxicological data are available. In particular, specialized carbon nanotube mixture, 8PPD, rambutan peel extract, and amine functionalized lignin are all complex mixtures with promising performance (chiefly in patents) but no available toxicity data. If such data are found or become available, they could also be considered in Stage 2.

Some possible alternatives that passed the initial screen described in Section 3 were subsequently eliminated from further evaluation in Stage 2 due to a lack of performance data or because available data indicated they would not perform well against ozone. Note that some of these eliminated chemistries were also dropped due to lack of toxicity data as noted above. These 18 eliminated possible alternatives due to performance data were:

- N,N'-diphenyl-p-phenylenediamine (DPPD)
- N-1,3-dimethyl butyl-N'-phenyl quinone diimine (6QDI)
- Polymerized 2,2,4-trimethyl-1,2-dihydroquinoline (TMQ)
- N,N'-Ditolyl-p-phenylenediamine (Commercial DTPD)
- Diaryl-p-phenylene diamine (DAPD)
- N,N'-Di-2-naphthyl-p-phenylenediamine (DNPDA)
- Nickel dibutyldithiocarbamate (NBC)
- Ethoxyquin
- Dilauryl thiodipropionate
- 4-(2,5-dimethyl-1H-pyrrol-1-yl)-N-phenylaniline

- 4-N-(2,3-dimethylphenyl)-1-N-phenylbenzene-1,4-diamine- R1 and R2 are methyl
- RU997, Irgazone 997 (Reaction product of N-phenyl-N'-(1,3dimethylbutyl)-p-phenylenediamine with an alkyl glycidylthioether)
- 2,4,6-tris-(N-1,4-dimethylpentyl-para-phenylenediamino)-1,3,5 triazine (Durazone 37 or TAPDT)
- N-Phenyl-1-naphthylamine
- N-Phenyl-2-naphthylamine
- 7-(4-methylpentan-2-ylamino)-2,3,4,10-tetrahydro-1H-acridin-9-one
- 2-cyclohexyl-N-(4-methylpentan-2-yl)-1H-indol-5-amine
- 4-(1H-indol-2-yl)-N-(4-methylpentan-2-yl)aniline

No possible alternatives were excluded based on relative exposure potential. Although some chemicals had different properties relevant for environmental mobility compared to 6PPD, it is not clear whether a chemical that is less water soluble but more fat soluble, or less water soluble but more volatile, would be a preferred alternative.

Investigation of possible alternatives to 6PPD is a highly active area of research. As noted above, one of the first tasks for the Stage 2 AA will be to review the recent scientific literature to determine if new data are available which could affect the decision to drop some alternatives from consideration.

6.4 Decision Concerning Abridged AA or Stage 2 AA

As noted in Section 6.1, a number of possible alternative antiozonants to replace 6PPD in motor vehicle tires were identified in the Stage 1 AA. Consequently, it is appropriate to carry these alternatives forward into the Stage 2 AA process where they will be examined in further detail consistent with the requirements of the SCP regulations.

7 Work Plan For Stage 2 AA

7.1 Tasks for Stage 2 AA and Final AA Report

The procedure for completing Stage 2 is outlined in the SCP regulations. The specific tasks we would undertake would be the following:

- Obtain DTSC approval on Stage 1 AA report (including resolving any comments received);
- Confirm that no new candidate alternatives have become available since the time of the Stage 1 submission; if these are available, we will determine their suitability for including in the analysis (*e.g.*, adding them to the Section 5 table to see if they are suitable);
- Update the hazard, performance, and exposure potential information for the 42 already identified possible alternatives based on new study data that becomes available after submission of the Stage 1 AA;
- Re-screen the available alternatives to understand which have sufficient data to support a Stage 2 AA;
- Revisit relevant factors for possible alternatives carried forward, as these could change;
- Perform a more in-depth evaluation of hazard and exposure potential (*e.g.*, looking more deeply into potential transformation products including their likelihood of being formed and their potential to migrate in the environment);
- Revisit the conceptual model to see if it requires revision for the revised set of possible alternatives;
- Update the literature search to be sure the most current information is available on product performance;
- Work with an economist to quantify the economic impacts of the priority product and possible alternatives;
- Use the sequential, simultaneous, or hybrid decision framework to evaluate possible alternatives and come to a decision;
- Prepare Stage 2 AA report;
- Include self-evaluation described in chapter 11 of DTSC's AA Guide (2017);
- Schedule a call with DTSC at the 6-month time point to discuss any issues that arise; and

At the end of the Stage 2 AA, we are optimistic that we will have identified one or more possible alternatives that hold promise to replace or materially reduce 6PPD in motor vehicle tires, subject to future performance testing to ensure comparable tire safety and performance. Additional toxicity testing may need to be performed to satisfy regulatory requirements and to fill important data gaps.

7.2 Proposed Stage 2 AA Completion Schedule

The SCP regulation requires an implementation schedule be submitted as part of the Stage 1 report. The following schedule is offered to comply with that requirement. Given the rapidly changing situation with research related to 6PPD alternatives, we reserve the right to adjust and modify this schedule as needs arise. We request a 1-year extension and have built that extension into the schedule to allow for additional preliminary performance testing of candidate alternatives in rubber and potential toxicity testing the Consortium envisions carrying out.

Table 7.1 Proposed Stage 2 AA Completion Schedule

Action Item	Potential Completion Date
	<u>All times below are after DTSC acceptance of Stage 1</u>
Update possible alternatives search Revisit conceptual model Initiate more in-depth hazard and exposure factor review	Weeks 1 to 8
Develop preliminary performance testing plan (NOT REQUIRED UNDER SCP)	
Develop additional toxicological testing plan (USGS, also NOT REQUIRED UNDER SCP)	
Engage with economist, begin assessment of economic impacts	Weeks 3 to 12
Meeting with DTSC to discuss issues expected in Stage 2	Week 4 to 6
Preliminary performance testing begins	Week 8
Additional tox testing begins	Week 8
Update performance database, determine if newer data are available	Weeks 8 to 48
Determine if newer hazard data on identified possible alternatives are available	Weeks 8 to 48
Revisit relevant factors for Stage 2 in light of reduced possible alternative set	Week 8
Initial data review/tabulation for hazard, exposure, performance, life cycle, and economics impact phase	Weeks 20 to 30
Discuss progress/outstanding questions with DTSC	Week 30
Explore decision frameworks	Weeks 30 to 32
Preliminary performance testing results available	Week 80
Evaluate preliminary performance testing results, follow up questions	Week 80
Incorporate preliminary performance testing results into decision framework	Week 81

Action Item	Potential Completion Date
Initial decision using appropriate decision framework	Week 82
Internal review of initial decision, QC by larger group	Week 85
Prepare final AA report	Weeks 86 to 92
Report review by Working Group	Weeks 92 to 94
Report review by full Consortium	Weeks 95 to 98
Revise final AA report, final edits	Weeks 99 to 103
Submit final AA report to DTSC	Week 104

Notes:

AA = Alternatives Analysis; DTSC = Department of Toxic Substances Control; QC = Quality Control; SCP = Safer Consumer Products.. Indented entries address testing that is not required under the SCP AA process.

8 Uncertainty Analysis

A number of possible sources of uncertainty were encountered in the course of conducting this Stage 1 AA. The key sources are summarized below.

Identification of Possible Alternatives. Alternatives were identified based on patent searches, journal article searches, general Internet searches, and surveys and conversations with Consortium members. It is possible that other alternative formulations exist and were not identified, but this is considered unlikely given that the AA was directed by a large Consortium with great familiarity with the industry and that the searches involved the major sources of information available about tire manufacturing. For any alternative that could have been missed (*e.g.*, an obscure patent, possibly not in English), it is doubtful whether it would have data on chemical composition, hazards, exposure, and performance and yet be unknown to the Consortium. Lacking such data, it would not likely affect the conclusions of the AA. Thus, the conclusions of this Stage 1 AA would not change.

Evaluation of Relevant Factors. For some of the relevant factors, the existence of material differences or lack thereof is fairly apparent. For example, it is clear from chemical manufacturing data that HFC or other high potency global warming gases are not used in the manufacturing process. Similarly, we can be fairly confident that while neither 6PPD nor any of the alternatives are listed under Proposition 65, many of the alternatives do contain components in their lifecycle that are listed (*e.g.*, benzene, toluene, nickel). On the other hand, data for particular toxic modalities are lacking for many of the alternatives, many of which do not even have CAS numbers. In addition, while data are available on the physical chemical properties from data sources such as EPI Suite, the exposure potential of the alternatives when formulated as part of a tire may be different from that of the pure chemical.

Hazard Evaluation. To evaluate the hazards of the alternatives, we primarily relied on ECHA REACH dossiers and GreenScreens. These two sources sometimes differed in terms of their assignment of particular hazard scores and we typically used the more conservative score in our CSI scoring process. However, GreenScreens were only available for a small subset of alternatives so not all alternatives had the same level of data. Due to the large number of alternatives examined, we also did not conduct an exhaustive literature review on each chemical of interest. Had we done so, we may have uncovered additional hazard data that could conflict with the data in the aforementioned sources or that could fill in data gaps. This more detailed evaluation of health hazard data will be conducted during Stage 2 of the AA process. Moreover, as noted above, the composition information we had on some of the patent-identified alternatives is for example formulations, which may not reflect the composition of any actual commercial product.

CSI Scoring for Human Health versus Aquatic Toxicity. In our CSI scoring system, described in Tables 5.5 to 5.7, we followed the scoring used in prior AAs which weighted human health concerns more heavily than ecological effects. Because DTSC has listed the priority product largely due to its reported effects on certain fish species, acute aquatic toxicity could have been weighted more heavily in the CSI scoring. To explore the impact of this question we conducted a sensitivity analysis and increased the scoring for acute and chronic aquatic toxicity (*e.g.*, the CSI score for acute and chronic GHS category 1 was doubled from 25 to 50, the penalty for data gaps was increased from 10 to 25, *etc.*). Under this revised scheme, the *overall* hazard score for 6PPD increased by 18%. The maximum increase among the possible alternatives was 36 percent for octyl gallate and the minimum increase was 0 percent (*i.e.*, no change) for Irganox 1520, dilauryl thiodipropionate and nickel dibutyldithiocarbamate. These are relatively modest changes and would not alter the final conclusions; octyl gallate and Irganox 1520 would still proceed to Stage 2 and the

other two chemicals either have poor performance against ozone or lack ozone data. Despite the higher aquatic toxicity score, the human health toxicity score for octyl gallate is low enough that it still meets the screening criteria in Table 5.15.

Evaluating Alternatives for Their Hazards *versus* 6PPD. In Table 5.15 we color coded the possible alternatives for their hazards relative to 6PPD. Whether an alternative had a hazard profile more desirable (green) or less desirable (red) than 6PPD was based on a CSI score more than 30 percent different from that of 6PPD. The 30 percent difference was arbitrary, although it is believed to be reasonable given the SCP requirement for alternatives that have a material difference from the priority product. To explore this further, we relaxed the color coding criteria to more or less than 20 percent different. A greater reduction in the evaluation criteria seemed unlikely to meet the requirement for "materially different". Under the less stringent evaluation scheme, several alternatives scored for overall hazard as being better than 6PPD *versus* being scored as similar to 6PPD. These were 77PD, commercial DTPD, DAPD, ethoxyquin, RU997, N-phenyl-1-naphthylamine, and N-phenyl-2-naphthylamine. No other changes in scoring were evident. These altered results would have no effect on the outcome of Stage 1 because 77PD was already selected to go onto stage 2 (it has promising performance data and its quinone appears much less toxic to coho salmon) whereas the others were rejected due to poor performance data (N-phenyl-2-naphthylamine was also dropped due to poor human health scores which also remains the case with the looser criteria).

Rejection of Alternatives with Extensive Data Gaps for Toxicity. Although we made reasonable efforts to evaluate the hazards of possible alternatives, for some chemicals the number of data gaps was so extensive that we felt we could not reliably evaluate their hazard in a way that would allow consistent comparison across possible alternatives. Read across approaches could have been applied but these involve some uncertainties. In addition, the fact that these chemicals lack substantial amounts of toxicological data suggests they would require a very substantial testing program before they could be adopted as a replacement for 6PPD, which could add multiple years to adoption of a potential alternative. Finally, many of the chemicals with very limited data for toxicity also lacked data for performance.

Environmental Transformation Products. Due to the release of antidegradant into the environment *via* TRWP, the potential for transformation or breakdown of the antidegradant into other chemicals is an important consideration in the AA. Unfortunately, information on potential environmental breakdown products for the possible alternatives is very limited. Aside from studies of 6PPD, we were unable to locate any studies examining the potential breakdown products of possible alternatives from reaction with ozone. For the PPDs, formation of quinones seems likely but the degree to which it occurs and the quinone persists in the environment is unknown. Information on ozone related breakdown products of the non-PPD alternatives was not located. We also could not find any modeling programs that would describe transformation with ozone. More generally, information on environmental breakdown products by other processes (*e.g.*, hydrolysis) was not present in the ECHA dossiers we consulted. A deeper examination using additional sources will be required in Stage 2 for the smaller number of alternatives considered viable based on hazard and initial screens of performance for the parent chemicals.

Performance. As discussed in Section 4, evaluation of the performance of an antidegradant in tires will involve a very large battery of tests, ranging from bench scale studies to field tests of manufactured tires placed on vehicles. The whole range of tests is likely to take several years to complete. Consequently, for this Stage 1 AA, we only had preliminary bench scale testing results available for a subset of possible alternatives. It is conceivable that alternatives that performed well in bench scale studies could fail to perform adequately in subsequent, more sophisticated tests. While this might not disqualify that alternative completely (because modifications may be possible to address the issues), it would impact the conclusions of the AA. In addition, the data we had available only covered a few of the alternatives. Although these were the ones that appeared most promising from a chemical structure basis, it is possible that if such data

were available for other alternatives, we could have reached different conclusions. It is hoped that additional data will be available for review in Stage 2.

Cost. We did not assess costs of the possible alternatives considered in Stage 1. Data on the bulk prices of specialty chemicals is particularly difficult to obtain. We did examine some chemical supplier websites (*e.g.*, Alibaba) but found that the ranges supplied from different suppliers were so broad that they were both of questionable accuracy and not likely to be useful. We did not consider cost of the possible alternatives in Stage 1. This will be done in Stage 2 where it is hoped that an economist on the team will provide guidance on this issue.

9 References

- Achawi, S; Feneon, B; Pourchez, J; Forest, V. 2021. "Structure-activity relationship of graphene-based materials: Impact of the surface chemistry, surface specific area and lateral size on their *in vitro* toxicity." *Nanomaterials (Basel)* 11(11):2963. doi: 10.3390/nano11112963.
- Ackerly KL, Roark KJ, Lu K, Esbaugh AJ, Liu Z, Nielsen KM. 2024. "Acute toxicity testing of 6PPD-quinone on the estuarine-dependent sport fish, *Sciaenops ocellatus*." *Ecotoxicology*. Aug;33(6):582-589. doi: 10.1007/s10646-024-02755-x. May 2.
- Akrochem Corp. 2002. "Use of waxes for ozone protection in rubber." 8p. Accessed on June 27, 2024 at https://www.akrochem.com/pdf/technical_papers/waxes_for_ozone_solutions.pdf.
- Akrochem Corp. 2010. "Antioxidants and antiozonants." 10p. Accessed on July 8, 2024 at https://www.akrochem.com/pdf/technical_papers/antiox_antioz_part1.pdf
- American Society for Testing and Materials (ASTM). 2017. "Standard Practice for Accelerated Laboratory Aging of Radial Passenger Car and Light Truck Tires through Load Range E for the Laboratory Generation of Belt Separation." ASTM F 2838-17. Accessed on March 6, 2024 at <https://www.astm.org/f2838-17.html>.
- Anderson-Bain, K; Roberts, C; Kohlman, E; Ji, X; Alcaraz, AJ; Miller, J; Gangur-Powell, T; Weber, L; Janz, D; Hecker, M; Montana, T; Brinkmann, M; Wiseman, S. 2023. "Apical and mechanistic effects of 6PPD-quinone on different life-stages of the fathead minnow (*Pimephales promelas*)." *Comp. Biochem. Physiol. C Toxicol. Pharmacol.* 271:109697. doi: 10.1016/j.cbpc.2023.109697.
- Beaudrie, C; Corbett, CJ; Lewandowski, TA; Malloy, T; Zhou, X. 2020. "Evaluating the application of decision analysis methods in simulated alternatives assessment case studies: Potential benefits and challenges of using MCDA." *Integr. Environ. Assess. Manag.* doi: 10.1002/ieam.4316.
- Bebb, R.L. 1976. "Chemistry of rubber processing and disposal." *Environ Health Perspect.* 17: 95–102.
- Bridgestone Corp. 2013. "Bridgestone Corporation reveals second generation 'air free concept (non-pneumatic) tire.'" November 21. Accessed on December 22, 2023 at <https://www.bridgestone.com/corporate/news/2013112101.html>
- California Air Resources Board (CARB). 2009. "Definitions of VOC and ROG (Revised)." 6p., January. Accessed on July 17, 2019 at https://ww3.arb.ca.gov/ei/speciate/voc_rog_dfn_1_09.pdf.
- California Air Resources Board (CARB). 2020. "CARB identified toxic air contaminants." Accessed on August 2, 2020 at <https://ww2.arb.ca.gov/resources/documents/carb-identified-toxic-air-contaminants>.
- California Dept. of Fish and Game. 2002. "Status Review of California Coho Salmon North of San Francisco." Report to California Fish and Game Commission. Candidate Species Status Review Report 2002-3. 336p., April. Accessed on March 6, 2024 at <https://nrm.dfg.ca.gov/FileHandler.ashx?DocumentID=121350>.

California Dept. of Resources Recycling and Recovery (CalRecycle). 2023. "Five-Year Plan for the Waste Tire Recycling Management Program (Twelfth Edition, Fiscal Years 2023-24 to 2027-28, Report to the Legislature)." DRRR-2023-1723. 73p., July 1. Accessed on March 18, 2024 at <https://www2.calrecycle.ca.gov/Publications/Details/1723>

California Dept. of Toxic Substances Control (CalDTSC). 2013a. "Safer Consumer Products." 22 CCR 55. 72p. Accessed on June 20, 2019 at <https://dtsc.ca.gov/wp-content/uploads/sites/31/2018/07/SCP-Final-Regs-Text-10-01-2013.pdf>.

California Dept. of Toxic Substances Control (CalDTSC). 2013b. "Alternatives Analysis: First stage." 22 CCR 69505.5. Accessed on March 6, 2024 at <https://www.law.cornell.edu/regulations/california/22-CCR-69505.5>

California Dept. of Toxic Substances Control (CalDTSC). 2017. "Alternatives Analysis Guide (Version 1.0)." 235p., June. Accessed on May 13, 2019 at https://dtsc.ca.gov/wp-content/uploads/sites/31/2016/01/AA-Guide-Version-1-0_June-2017.pdf.

California Dept. of Toxic Substances Control (CalDTSC). 2022. "Product - Chemical Profile for Motor Vehicle Tires Containing N-(1,3-Dimethylbutyl)-N'-phenyl-p-phenylenediamine (6PPD) (Final Version)." 102p., March.

California Dept. of Toxic Substances Control (CalDTSC), Safer Consumer Products Program. 2024. "Adopted Priority Product: Motor vehicle tires containing 6PPD." 102p. Accessed on June 27, 2024 at https://dtsc.ca.gov/scp/motor_vehicle_tires_containing_6ppd/.

California Office of Environmental Health Hazard Assessment (CalOEHHA). 2012. "Green Chemistry Hazard Traits for California's Toxics Information Clearinghouse." 22 CCR 54. 29p. Accessed on September 7, 2023 at <https://oehha.ca.gov/media/downloads/risk-assessment/gcregtext011912.pdf>.

California Office of Environmental Health Hazard Assessment (CalOEHHA). 2024. "The Proposition 65 List." Accessed on January 4, 2024 at <https://oehha.ca.gov/proposition-65/proposition-65-list>.

California, State Assembly. 2003. "Assembly Bill No. 844: An act to add Chapter 8.7 (commencing with Section 25740) to Division 15 of the Public Resources Code, relating to tire efficiency." AB 844. 4p., February 20. Accessed on March 6, 2024 at http://www.leginfo.ca.gov/pub/03-04/bill/asm/ab_0801-0850/ab_844_bill_20030602_amended_asm.pdf

Cao, G; Wang, W; Zhang, J; Wu, P; Zhao, X; Yang, Z; Hu, D; Cai, Z. 2022. "New evidence of rubber-derived quinones in water, air, and soil." *Environ. Sci. Technol.* 56(7):4142-4150. doi: 10.1021/acs.est.1c07376.

Chapelet, KK; Al-Afyouni, MH; Tyhurst, J; Penney, JM; Roselli, C; Kuppusamy, SP; Ross, TL; Zhang, L; Gallagher, SP; Aufderheide, J; Brougher, DS. 2023. "77PD-Quinone: Synthesis, coho salmon toxicity assessment, and comparison with the commercial antidegradant 77PD." *ChemRxiv* doi: 10.26434/chemrxiv-2023-g7n49.

Choi, SS. 2001. "Influence of rubber composition on migration behaviors of antiozonants in carbon black-filled rubber vulcanizates composed of NR, SBR, and BR." *J. Appl. Polym. Sci.* 81(1):237-242. doi: 10.1002/app.1434.

Clean Production Action. 2018. "GreenScreen Chemical Hazard Criteria." In GreenScreen® for Safer Chemicals Hazard Assessment Guidance (Version 1.4). 19p., January. Accessed on August 6, 2019 at https://www.greenscreenchemicals.org/images/ee_images/uploads/resources/GreeScreen1.4-Annex1-1.18.pdf.

Clean Production Action. 2019. "GreenScreen® for Safer Chemicals." Accessed on June 20, 2019 at <https://www.cleanproduction.org/programs/greenscreen>.

Commission of the European Communities. 2001. "Communication from the Commission to the Council and the European Parliament on the Implementation of the Community Strategy for Endocrine Disrupters: A Range of Substances Suspected of Interfering with the Hormone Systems of Humans and Wildlife (COM (1999) 706)." COM(2001) 262 final. 45p., June 14.

Cox; W,L. 1958. "Chemical Antiozonants and Factors Affecting their Utility." Symposium on Effect of Ozone on Rubber. Ed. Maassen, GC. 100 Barr Harbor Drive, PO Box C700, West Conshohocken, PA 19428-2959: ASTM International.

Dall'Abaco, D; Formaggio, V; Rossiello, L; Hanel, T. [Pirelli Tyre S.P.A.]. 2018. "Tyre for Vehicle Wheels." International Publication No. WO 2018/163041 A2. 25p., September 13. Accessed on January 4, 2024 at <https://patentimages.storage.googleapis.com/bb/94/42/85b1f121fe5a90/WO2018163041A2.pdf>.

Danish Environmental Protection Agency. 2023. "Endocrine Disruptor Lists." February. Accessed on August 30, 2023 at <https://edlists.org/the-ed-lists>.

Davies, KM; Neale, AJ. 1969. "p-Phenylenediamine Derivatives and Their Use as Antiozonants for Rubber." British Patent Specification GB 1,146,517. 7p., March 26.

Dong, Y; Zhao, Y; Hossain, MD; He, Y; Liu, P. 2021. "Life cycle assessment of vehicle tires: A systematic review." *Clean. Environ. Syst.* 2:100033. doi: 10.1016/j.cesys.2021.100033.

Environmental Risk Management Authority of New Zealand (ERMA). 2005. "Hazardous Substances Standing Committee Decision [re: CIBA Specialty Chemicals New Zealand Ltd.'s application to import and manufacture Irgazone 997]." Application Code: HSR05063. 18p, October 8. Accessed on October 11, 2023 at <https://www.epa.govt.nz/assets/FileAPI/hsno-ar/HSR05063/HSR05063.doc>.

European Chemicals Agency (ECHA). 2020. "Information on Chemical Substances; Registered substances; Reach dossiers." Accessed on September 17, 2020 at <https://echa.europa.eu/information-on-chemicals/registered-substances>.

European Chemicals Agency (ECHA). 2024. "REACH - Registration, Evaluation, Authorisation and Restriction of Chemicals Regulation Registered Substances Factsheets." Accessed on January 4, 2024 at <https://echa.europa.eu/information-on-chemicals/registered-substances>.

European Food Safety Authority (EFSA), Panel on Food Additives and Nutrient Sources added to Food (ANS). 2015. "Scientific Opinion on the re-evaluation of octyl gallate (E 311) as a food additive." *EFSA J.* 13(10):4248. doi: 10.2903/j.efsa.2015.4248.

European Association of the Rubber Industry (BLIC). 2001. "Life cycle assessment of an average European car tyre." 4p., September 27.

Fadeel, B; Bussy, C; Merino, S; *et al.* 2018. "Safety assessment of graphene-based materials: Focus on human health and the environment." *ACS Nano* 12(11):10582-10620. doi: 10.1021/acsnano.8b04758.

Fiume, MM; Bergfeld, WF; Belsito, DV; Hill, RA; Klaassen, CD; Liebler, DC; Marks, JG Jr.; Shank, RC; Slaga, TJ; Snyder, PW; Gill, LJ; Heldreth, B. 2019. "Safety assessment of monosaccharides, disaccharides, and related ingredients as used in cosmetics." *Int. J. Toxicol.* 38(Suppl. 1):5S-38S. doi: 10.1177/1091581818814189.

Foldvik, A., Kryuchkov, F., Sandodden, R. and Uhlig, S. 2022. "Acute Toxicity Testing of the Tire Rubber-Derived Chemical 6PPD-quinone on Atlantic Salmon (*Salmo salar*) and Brown Trout (*Salmo trutta*)." *Environ Toxicol Chem.* 41: 3041-3045. <https://doi.org/10.1002/etc.5487>.

Foldvik, A; Kryuchkov, F; Ulvan, EM; Sandodden, R; Kvingedal, E. 2024. "Acute toxicity testing of pink salmon (*Oncorhynchus gorbuscha*) with the tire rubber-derived chemical 6PPD-quinone" *Environ. Toxicol. Chem.* doi: 10.1002/etc.5875.

Freedhoff, M. [US EPA, Assistant Administrator for Chemical Safety and Pollution Prevention]. 2023. "Letter to E. Forsyth and K. O'Brien (Earthjustice) re: Petition ID No. 001845: Toxic Substances Control Act Section 21 petition regarding N-(1,3-Dimethylbutyl)-N'-phenyl-p-phenylenediamine (CASRN 793-24-8, aka 6PPD) in tires - Final EPA response to petition [Decision Letter]." 6p., November 2. Accessed on March 19, 2024 at https://www.epa.gov/system/files/documents/2023-11/pet-001845_tsca-21_petition_6ppd_decision_letter_esigned2023.11.2.pdf

Goodyear. 2023. "Goodyear's airless tire solution." Accessed on December 22, 2023 at <https://corporate.goodyear.com/us/en/responsibility/blog/advanced-mobility-beyond-tires-journey/airless-tire-solution.html>

Greer, JB; Dalsky, EM; Lane, RF; Hansen, JD. 2023a. "Establishing an *in vitro* model to assess the toxicity of 6PPD-quinone and other tire wear transformation products." *Environ. Sci. Technol. Lett.* 10(6):533-537. doi: 10.1021/acs.estlett.3c00196.

Greer JB, Dalsky EM, Lane RF, Hansen JD. 2023b *Tire-Derived Transformation Product 6PPD-Quinone Induces Mortality and Transcriptionally Disrupts Vascular Permeability Pathways in Developing Coho Salmon.* " *Environ Sci Technol.* 2023 Aug 1;57(30):10940-10950.

Healthy Building Network. 2020. "Pharos Service." Accessed on September 17, 2020 at <https://pharosproject.net/>.

Hiki, K; Yamamoto, H. 2022. "The tire-derived chemical 6PPD-quinone is lethally toxic to the white-spotted char *Salvelinus leucomaenis pluvius* but not to two other salmonid species." *Environ. Sci. Technol. Lett.* 9(12):1050-1055. doi: 10.1021/acs.estlett.2c00683.

Hopper, RJ. 1976. "Improved cocure of EPDM-polydiene blends by conversion of EPDM into macromolecular cure retarder." *Rubber Chem. Technol.* 49(2):341-352. doi: 10.5254/1.3534969.

Hu, X; Zhao, HN; Tian, Z; Peter, KT; Dodd, MC; Kolodziej, EP. 2022. "Transformation product formation upon heterogeneous ozonation of the tire rubber antioxidant 6PPD (N-(1,3-dimethylbutyl)- N'-phenyl- p-phenylenediamine)." *Environ. Sci. Technol. Lett.* 9(5):413-419. doi: 10.1021/acs.estlett.2c00187.

Intergovernmental Panel on Climate Change (IPCC); Stocker, TF; Qin, D; Plattner, GK; Tignor, M; Allen, SK; Boschung, J; Nauels, A; Xia, Y; Bex, V; Midgley, PM; eds. 2013. "Climate Change 2013: The Physical Science Basis, Working Group I Contribution to the Fifth Assessment Report of the Intergovernmental Panel on Climate Change." Cambridge University Press (Cambridge, UK). 1552p. Accessed on February 21, 2017 at <https://www.ipcc.ch/report/ar5/wg1/>.

Johannessen, C; Saini, A; Zhang, X; Harner, T. 2022. "Air monitoring of tire-derived chemicals in global megacities using passive samplers." *Environ. Pollut.* 314:120206. doi: 10.1016/j.envpol.2022.120206.

Kimber, I; Poole, A; Basketter, DA. 2018. "Skin and respiratory chemical allergy: Confluence and divergence in a hybrid adverse outcome pathway." *Toxicol. Res. (Camb)* 7(4):586-605. doi: 10.1039/c7tx00272f.

Krongauz, VV; Lee, YP; Bourassa, A. 2011. "Kinetics of thermal degradation of poly(vinyl chloride): Thermogravimetry and spectroscopy." *J. Therm. Anal. Calorim.* 106(1):139-149. doi: 10.1007/s10973-011-1703-6.

Kuczkowski, JA. 1990. "The inhibition of oxidative and ozonic processes in elastomers." In *Oxidation Inhibition in Organic Materials: Volume I*. (Eds.: Pospisil, J; Klemchuk, PP), CRC Press, Inc., Boca Raton, FL. p247-290.

Lederer, DA; Fath, MA. 1981. "Effects of wax and substituted p-phenylenediamine antiozonants in rubber." *Rubber Chem. Technol.* 54(2):415-426. doi: 10.5254/1.3535814.

Liao, XL; Chen, ZF; Ou, SP; Liu, QY; Lin, SH; Zhou, JM; Wang, Y; Cai, Z. 2024. "Neurological impairment is crucial for tire rubber-derived contaminant 6PPDQ-induced acute toxicity to rainbow trout." *Sci. Bull. (Beijing)* 69(5):621-635. doi: 10.1016/j.scib.2023.12.045.

Lo, BP; Marlatt, VL; Liao, X; Reger, S; Gallilee, C; Ross, ARS; Brown, TM. 2023. "Acute toxicity of 6PPD-quinone to early life stage juvenile Chinook (*Oncorhynchus tshawytscha*) and Coho (*Oncorhynchus kisutch*) salmon." *Environ. Toxicol. Chem.* 42(4):815-822. doi: 10.1002/etc.5568.

Mansouri, K; Grulke, CM; Judson, RS; Williams, AJ. 2018. "OPERA models for predicting physicochemical properties and environmental fate endpoints." *J. Cheminform.* 10:10. doi: 10.1186/s13321-018-0263-1.

McIntyre, JK; Prat, J; Cameron, J; Wetzel, J; Mudrock, E; Peter, KT; Tian, Z; Mackenzie, C; Lundin, J; Stark, JD; King, K; Davis, JW; Kolodziej, EP; and Scholz, NL. "Treading Water: Tire Wear Particle Leachate Recreates an Urban Runoff Mortality Syndrome in Coho but Not Chum Salmon." *Environmental Science & Technology*. 2021 55 (17), 11767-11774. doi: 10.1021/acs.est.1c03569.

Michelin. 2021. "e.PRIMACY tire [Product information]." 10p., January.

Michelin. 2023. "Airless: A technology that eliminates the risk of flats and rapid pressure loss and reduces environmental impact." Accessed on December 22, 2023 at <https://www.michelin.com/en/innovation/vision-concept/airless/>

Molecular Rebar Design, LLC. 2015. "Research Sample Safety Data Sheet for MR 1420X DLC." 6p.

Montgomery, D; Ji, X; Cantin, J; Philibert, D; Foster, G; Selinger, S; Jain, N; Miller, J; McIntyre, J; de Jourdan, B; Wiseman, S; Hecker, M; Brinkmann, M. 2023. "Interspecies differences in 6PPD-quinone toxicity across seven fish species: Metabolite identification and semiquantification." *Environ. Sci. Technol.* 57(50):21071-21079. doi: 10.1021/acs.est.3c06891.

Nair, P; Sun, J; Xie, L; Kennedy, L; Kozakiewicz, D; Kleywegt, S; Hao, C; Byun, H; Barrett, H; Baker, J; Monaghan, J; Krogh, E; Song, D; Peng, H. 2023. "Synthesis and toxicity evaluation of tire rubber-derived quinones." *ChemRxiv* doi: 10.26434/chemrxiv-2023-pmxvc.

North, CM; Ezendam, J; Hotchkiss, JA; Maier, C; Aoyama, K; Enoch, S; Goetz, A; Graham, C; Kimber, I; Karjalainen, A; Pauluhn, J; Roggen, EL; Selgrade, M; Tarlo, SM; Chen, CL. 2016. "Developing a framework for assessing chemical respiratory sensitization: A workshop report." *Regul. Toxicol. Pharmacol.* 80:295-309. doi: 10.1016/j.yrtph.2016.06.006.

Organisation for Economic Co-operation and Development (OECD). 2017. "Application manual of OECD QSAR Toolbox v.4." 463p. Accessed on March 6, 2024 at https://www.oecd.org/chemicalsafety/risk-assessment/TB4_Application_manual_F1.compressed.pdf.

Paschall, D; Rodgers, MB; Halasa, AF. [Akron Polymer Solutions, Inc.]. 2023. "Graphene as an Additive as a Nucleating Agent." US Patent 2023/0383091 A1. 10p., November 30. Accessed on July 8, 2024 at <https://patentimages.storage.googleapis.com/d9/dc/1e/7644ba027a0370/US20230383091A1.pdf>

Peddini, SK; Krupp, AC; Henderson, N. [Molecular Rebar Design, LLC]. 2021. "Mixtures of Discrete Carbon Nanotubes." US Patent 11,053,362 B2. 32p., July 6. Accessed on July 8, 2024 at <https://patentimages.storage.googleapis.com/6d/ce/b1/960e90a938e989/US11053362.pdf>

Piotrowska, K; Kruszelnicka, W; Bałdowska-Witos, P; Kasner, R; Rudnicki, J; Tomporowski, A; Flizikowski, J; Opielak, M. 2019. "Assessment of the environmental impact of a car tire throughout its lifecycle using the LCA method." *Materials (Basel)* 12(24):4177. doi: 10.3390/ma12244177.

PPG Industries; Dos Santos Freire, L; Brenner, T. 2020. "Advanced Non-Tread Materials for Fuel-Efficient Tires." doi: 10.2172/1643340. Report to US Dept. of Energy (US DOE), Office of Energy Efficiency and Renewable Energy (EERE). DE-EE0007759, DOE-PPG-11111-1. 49p., July 27. Accessed on July 15, 2024 at <https://www.osti.gov/biblio/1643340>

Rossomme, E; Hart-Cooper, WM; Orts, WJ; McMahan, C; Head-Gordon, M. 2023. "Computational studies of rubber ozonation explain the effectiveness of 6PPD as an antidegradant and the mechanism of its quinone formation." *Environ. Sci. Technol.* 57(13):5216-5230. doi: 10.1021/acs.est.2c08717.

Sandstrom, PH. 1992. "Tread Compounds Containing Modified EPDM Which Exhibit Good Abrasion Resistance and Improved Hysteresis Properties." European Patent Application No. 0 508 169 A2. 11p., March 18.

Scholz, NL; Myers, MS; McCarthy, SG; Labenia, JS; McIntyre, JK; Ylitalo, GM; Rhodes, LD; Laetz, CA; Stehr, CM; French, BL; McMillan, B; Wilson, D; Reed, L; Lynch, KD; Damm, S; Davis, JW; Collier, TK. 2011. "Recurrent die-offs of adult coho salmon returning to spawn in Puget Sound lowland urban streams." *PLoS ONE* 6(12):e28013. doi: 10.1371/journal.pone.0028013.

Schunk, A. 2022. "USTMA, California EPA move ahead with 6ppd 'alternatives analysis'." *Rubber News*. September 26. Accessed on December 22, 2023 at <https://www.rubbernews.com/news/ustma-california-epa-look-for-alternative-6ppd-tire-additive>.

Sheridan, MF; ed. 2010. "The Vanderbilt Rubber Handbook (14th Edition)." R.T. Vanderbilt Co. (Norwalk, CT). 987p. Accessed on February 5, 2024 at <https://www.scribd.com/document/521171397/Vanderbilt-Rubber-Handbook>.

The Graphene Council; Barkan, T. 2023. "Is graphene safe?" June 12. Accessed on March 18, 2024 at <https://www.thegraphenecouncil.org/blogpost/1501180/490084/Is-Graphene-Safe>

The Tyre Collective Ltd.. 2024. "The Tyre Collective." Accessed on March 18, 2024 at <https://thetyrecollective.com/>

Tian, Z; Gonzalez, M; Rideout, CA; Zhao, HN; Hu, X; Wetzel, J; Mudrock, E; James, CA; McIntyre, JK; Kolodziej, EP. 2022. "6PPD-quinone: Revised toxicity assessment and quantification with a commercial standard." *Environ. Sci. Technol. Lett.* 9(2):140-146. doi: 10.1021/acs.estlett.1c00910.

Tian, Z; Zhao, H; Peter, KT; *et al.* 2021. "A ubiquitous tire rubber-derived chemical induces acute mortality in coho salmon." *Science* 371(6525):185-189. doi: 10.1126/science.abd6951.

Tinker, AJ; Jones, KP; eds.. 1998. "Blends of Natural Rubber: Novel Techniques for Blending with Specialty Polymers." Chapman & Hall, London, UK. 271p.

ToxServices LLC. 2021a. "N-(1,3-Dimethylbutyl)-N'-Phenyl-p-Phenylenediamine (6PPD) (CAS #793-24-8) GreenScreen® for Safer Chemicals (GreenScreen®) Assessment." GS-1204. 73p., November 8.

ToxServices LLC. 2021b. "N,N'-Bis(1,4-dimethylpentyl)-p-phenylenediamine (77PPD) (CAS# 3081-14-9) GreenScreen® for Safer Chemicals (GreenScreen®) Assessment." GS-1200. 53p., November 9.

ToxServices LLC. 2021c. "N-Isopropyl-N'-phenyl-p-phenylenediamine (IPPD) (CAS# 101-72-4) GreenScreen® for Safer Chemicals (GreenScreen®) Assessment." GS-1202. 75p., October 14.

ToxServices LLC. 2021d. "N-1,3-dimethyl Butyl-N'-Phenyl Quinone Diamine (6QDI) (CAS #52870-46-9) GreenScreen® for Safer Chemicals (GreenScreen®) Assessment." GS-1206. 72p., November 8.

ToxServices LLC. 2021e. "2,2,4-Trimethyl-1,2-Dihydroquinoline (TMDHQ) (CAS# 147-47-7) GreenScreen® for Safer Chemicals (GreenScreen®) Assessment." GS-1205. 52p., November 4.

ToxServices LLC. 2021f. "N-(1,4-Dimethylpentyl)-N'-Phenylbenzene-1,4-Diamine (CAS# 3081-01-4) GreenScreen® for Safer Chemicals (GreenScreen®) Assessment." GS-1203. 52p., October 21.

ToxServices LLC. 2021g. "N,N'-Dicyclohexyl-4-phenylenediamine (CCPD) (CAS# 4175-38-6) GreenScreen® for Safer Chemicals (GreenScreen®) Assessment." GS-1201. 53p., November 5.

ToxServices LLC. 2021h. "Nickel Dibutyldithiocarbamate (CAS# 13927-77-0) GreenScreen® for Safer Chemicals (GreenScreen®) Assessment." GS-1207. 43p., November 8.

ToxServices LLC. 2021i. "6-Ethoxy-2,2,4-trimethyl-1,2-dihydroquinoline (Ethoxyquin) (CAS# 91-53-2) GreenScreen® for Safer Chemicals (GreenScreen®) Assessment." GS-1208. 84p., November 8.

ToxServices LLC. 2021j. "Dilauryl Thiodipropionate (CAS# 123-28-4) GreenScreen® for Safer Chemicals (GreenScreen®) Assessment." GS-108. 99p., November 12.

UL LLC. 2023. "Illuminator Chemical Regulatory Monitoring Software." Accessed on February 16, 2023 at <https://www.ul.com/software/illuminator-chemical-regulatory-monitoring-software>.

United Kingdom, Health and Safety Executive. 2021. "List of substances that can cause occupational asthma." Accessed on March 2, 2021 at <https://www.hse.gov.uk/asthma/substances.htm>

United Nations. 2019. "Globally Harmonized System of Classification and Labelling of Chemicals (GHS) (Eighth Revised Edition)." ST/SG/AC.10/30/Rev.8. 570p. Accessed on October 30, 2019 at https://www.unece.org/fileadmin/DAM/trans/danger/publi/ghs/ghs_rev08/ST-SG-AC10-30-Rev8e.pdf.

US Congress. 1966. "Public Law 89-563: An act to provide for a coordinated national safety program and establishment of safety standards for motor vehicles in interstate commerce to reduce accidents involving motor vehicles and to reduce the deaths and injuries occurring in such accidents [National Traffic and Motor Vehicle Safety Act of 1966]." PL 89-563, 80 Stat 718. September 9. Accessed on March 6, 2024 at <https://www.govinfo.gov/content/pkg/STATUTE-80/pdf/STATUTE-80-Pg718.pdf>.

US Congress. 2020. "Public Law 106-414: An act to amend Title 49, United States Code, to require reports concerning defects in motor vehicles or tires or other motor vehicle equipment in foreign countries, and for other purposes [Transportation Recall Enhancement, Accountability, and Documentation (TREAD) Act]." 114 Stat. 1800, Public Law 106-414. November 1. Accessed on March 19, 2024 at <https://www.congress.gov/bill/106th-congress/house-bill/5164>

US Dept. of Transportation (US DOT). 2006. "The Pneumatic Tire." DOT HS 810 561. 707p., February. Accessed on March 6, 2024 at https://www.nhtsa.gov/sites/nhtsa.gov/files/pneumatictire_hs-810-561.pdf.

US Dept. of Transportation (US DOT), Federal Highway Administration (FHWA). 2022. "Highway Statistics 2022." Accessed on March 6, 2024 at <https://www.fhwa.dot.gov/policyinformation/statistics/2022/>.

US Dept. of Transportation (US DOT), National Highway Traffic Safety Administration (NHTSA). 2023. "Traffic Safety Facts 2021: A Compilation of Motor Vehicle Crash Data." DOT HS 813 527. 225p., December. Accessed on March 20, 2024 at <https://crashstats.nhtsa.dot.gov/Api/Public/ViewPublication/813527>

US EPA. 1975. "Environmental Aspects of Chemical Use in Rubber Processing Operations (Conference Proceedings)." EPA-560/1-75-002, NTIS PB-244172. 446p., July.

US EPA. 1990. "Methodology for estimating the migration of additives and impurities from polymeric chemicals." Office of Pesticides and Toxic Substances. EPA 560-5-85-015. 158 p. Accessed on July 15, 2024 at https://19january2017snapshot.epa.gov/sites/production/files/2015-09/documents/amem_user_guide.pdf.

US EPA. 2012. "SmartWay Verified Low Rolling Resistance Tires: Performance Requirements." EPA-420-F-12-024. 1p., May. Accessed on March 6, 2024 at <https://www.epa.gov/sites/default/files/2016-02/documents/420f12024.pdf>.

US EPA. 2013. "Interpretive Assistance Document for Assessment of Discrete Organic Chemicals: Sustainable Futures Summary Assessment." 20p., June. Accessed on September 24, 2020 at https://www.epa.gov/sites/production/files/2015-05/documents/05-iad_discretes_june2013.pdf.

US EPA. 2016. "Frequent questions on tire derive fuel/scrap tires" Accessed on July 15, 2024 at <https://archive.epa.gov/epawaste/conservation/materials/tires/web/html/faq-tdf.html>. Access 7/15/24.

US EPA. 2018. "Ozone-Depleting Substances." July 31. Accessed on June 20, 2019 at <https://www.epa.gov/ozone-layer-protection/ozone-depleting-substances>.

US EPA. 2019. "EPI Suite™ - Estimation Program Interface." March 12. Accessed on June 20, 2019 at <https://www.epa.gov/tsca-screening-tools/epi-suitetm-estimation-program-interface>.

US EPA. 2021. "ECOTOXicology Knowledgebase (ECOTOX) (Version 5)." March 15. Accessed on May 14, 2021 at <https://cfpub.epa.gov/ecotox/>.

US EPA. 2022. "EPA Verification Protocols for Low Rolling Resistance Retread Products." 6p., February. Accessed on March 6, 2024 at <https://www.epa.gov/system/files/documents/2022-03/retread-verification-protocols-2022-02-25.pdf>.

US EPA. December 18, 2023a. "Significant New Use Rules on certain chemical substances (22-2.5e) (Final rule)." *Fed. Reg.* 88(241):87346-87358. 40 CFR 9, 40 CFR 721. Accessed on June 27, 2024 at <https://www.federalregister.gov/documents/2023/12/18/2023-27653/significant-new-use-rules-on-certain-chemical-substances-22-25e>.

US EPA. 2023b. "CompTox Chemicals Dashboard." November 29. Accessed on January 4, 2024 at <https://www.epa.gov/comptox-tools/comptox-chemicals-dashboard>.

US EPA. 2024. "Grantee research project results [re: "Reduction or Replacement of 6PPD through Improved Ozonation-related Crack Resistance with MOLECULAR REBAR"]." Accessed on June 27, 2024 at https://cfpub.epa.gov/ncer_abstracts/index.cfm/fuseaction/display.abstractDetail/abstract_id/11459/report/0.

U.S. Tire Manufacturers Association (USTMA). 2017a. "Care and Service of Passenger and Light Truck Tires." 58p.

U.S. Tire Manufacturers Association (USTMA). 2017b. "Care and Service of Commercial Truck and Bus Tires." 86p. Accessed on March 19, 2024 at https://www.ustires.org/sites/default/files/CareAndService_Commercial_TruckBusTires_0.pdf

U.S. Tire Manufacturers Association (USTMA). 2024. "Factbook 2024." 10p.

Verslycke, T; Reid, K; Bowers, T; Thakali, S; Lewis, A; Sanders, J; Tuck, D. 2014. "The Chemistry Scoring Index (CSI): A hazard-based scoring and ranking tool for chemicals and products used in the oil and gas industry." *Sustainability* 6:3993-4009. doi: 10.3390/su6073993. Accessed on July 07, 2014 at <http://www.mdpi.com/2071-1050/6/7/3993>.

Washington State Dept. of Ecology (WA Ecology). 2021. "Technical memorandum to J. Fitzgibbon (House Environment & Energy Committee), *et al.* re: Assessment of potential hazards of 6PPD and alternatives." 21p., November 29.

Washington State Dept. of Ecology (WA Ecology). 2022. "6PPD in Road Runoff: Assessment and Mitigation Strategies." Report to Washington State Legislature, Model Toxics Control Act Legislative Program. Publication 22-03-020. 234p., October. Accessed on March 6, 2024 at <https://apps.ecology.wa.gov/publications/documents/2203020.pdf>.

Zerin, NH; Rasul, MG; Jahirul, MI; Sayem, ASM. 2023. "End-of-life tyre conversion to energy: A review on pyrolysis and activated carbon production processes and their challenges." *Sci. Total Environ.* 905:166981. doi: 10.1016/j.scitotenv.2023.166981.

Tables and Figures

Table 4.4 Consideration of Potentially Relevant Factors Identified in the SCP Regulations

Category	Factor that Is Relevant if Materially Different Between Priority Product and Alternatives	Relevant?*	Basis
Life Cycle Segments	Raw materials extraction	Unlikely for most alternatives, but data are limited. Potentially for amine treated lignin and rambutan peel extract.	While there are multiple LCAs for tires that characterize resource inputs such as energy, water, and other material requirements (Michelin, 2021; Dong <i>et al.</i> , 2021; Piotrowska <i>et al.</i> , 2019), there are no LCAs which focus specifically on the impacts associated with having 6PPD in tires nor is there an LCA available for any of the possible alternatives if present in a tire. A review of general information on chemical production for the functional ingredients in the products (Table 4.6) suggests that, qualitatively, there are unlikely to be material differences between them, as most involve inputs involving fossil fuels and/or mined materials of various types (<i>e.g.</i> , metals, calcium carbonate). There are multiple methods for producing graphene and carbon nanotubes but the most common involves deposition of methane (typically fossil fuel derived) onto a substrate. For amine functionalized lignin, the base material, lignin, is a byproduct of wood processing so might involve no new materials extraction, assuming lignin from wood processing could meet the needs of tire production. Rambutan peel extract is an agricultural product and its production at the scale needed for tire production could have adverse impacts on land use. The same could be said of octyl gallate which can be derived from fatty acids (<i>e.g.</i> , coconut fatty acid), although it can also be synthesized from fossil fuel-based precursors. If the active antiozonant(s) are identified these could be produced industrially, likely from fossil fuel-based materials.
	Resource inputs and other resource consumption	Unclear	We define this life cycle segment as involving the resources used and consumed to produce the ingredients used as input for tire manufacturing, but not tire manufacturing itself, which is addressed below. There is no LCA available that specifically addresses the resource inputs or consumption associated with producing 6PPD or the possible alternatives for use in tires. Data on the inputs (other than chemical inputs discussed in Table 4.6) required to produce 6PPD and the possible alternatives are lacking. Production of graphene appears to be a highly energy intensive process (<i>i.e.</i> , high temperatures) but again, no data are available to allow comparison to other possible alternatives. Information is lacking regarding production of amine functionalized lignin or rambutan peel extract in terms of the reagents or other inputs required because these specific materials are listed in patents and do not appear to be produced at scale commercially (although for rambutan peel extract the processing could be limited). It is also conceivable that some possible alternatives would be produced at different locations which could have different impacts in terms of raw material and chemical intermediate transportation (both in terms of distance and transportation mode). However, data are lacking to assess such effects; it is unclear how production of an alternative antiozonant could change in terms of suppliers and their locations in order to meet demand and moreover, transportation networks would likely change significantly to increase efficiency due to the large volume of antidegradant involved. Analyzing the potential suppliers and their geographic locations for the possible alternatives under consideration was considered outside the scope of the Stage 1 AA.
	Intermediate materials production processes	Unlikely, but data are limited	A review of information on the chemical precursors of the functional ingredients in the Priority Product and possible alternatives (as summarized in Table 4.6) suggests that the PPD-related alternatives have

Category	Factor that Is Relevant if Materially Different Between Priority Product and Alternatives	Relevant?*	Basis
			essentially equivalent intermediate materials and processes as 6PPD. Most of the non-PPD materials (<i>e.g.</i> , TMQ, ethoxyquin, NBC, DLTDP, graphene) involve different chemistries but all involve industrial chemicals with significant hazard (<i>e.g.</i> , nickel for NBC, ethoxyquin and DLTDP involve various acids). The details (and therefore hazards) of producing amine functionalized lignin are unknown as this material is proposed in a patent. Various internet searches for companies producing amine functionalized lignin (of any type) were not informative. Some hazardous chemicals may be associated with lignin extraction such as formaldehyde or methanol (see Table 4.6). Likewise, some hazardous chemicals may be involved in production of rambutan peel extract (<i>e.g.</i> , methanol, hydrochloric acid) although details related to large scale extraction are lacking. The active ingredients in rambutan peel extract may also need to be produced synthetically and various searches for rambutan peel extract synthesis did not uncover any data for this. The hazards of graphene depend on the structure (<i>i.e.</i> , thickness) and stage of the production process.
	Product manufacture	Possible, but data are limited	As noted above, this lifecycle segment pertains to the hazards and impacts of producing the Priority Product and possible alternatives (<i>i.e.</i> , tires). As indicated in Tables 5.1 to 5.3, all the antidegradants pose some hazards which could be relevant for workers during exposure. It should be noted that the antidegradant comprises a small percentage of the mass of the tire and it is assumed that all other ingredients (<i>e.g.</i> , rubbers, fabric belts, steel, carbon black, silica, other additives) will largely remain the same. The extent to which some additives may change with a new antidegradant is not currently known. Moreover, tires will still require vulcanization which constitutes the major source of energy required during the production process. Thus overall, it appears that changing the antidegradant will not have a material difference on the impacts of the manufacturing stage but data are too limited to be certain. How the manufacturing process would change with a new antidegradant is unknown because it may require changes in tire formulation or production. We are unaware of any studies of potential worker exposure to any of the chemicals under study. This will need to be further explored in Stage 2.
	Packaging	Unlikely	This lifecycle segment pertains to the hazards and impacts of packaging the Priority Product and possible alternatives (<i>i.e.</i> , tires). Tires are packaged as either single units or on pallets. A change in the antidegradant appears unlikely to affect how the priority product is packaged.
	Distribution	Unclear	This lifecycle segment pertains to the hazards and impacts of transporting the Priority Product and possible alternatives (<i>i.e.</i> , tires) to various sales sites. It is unlikely that the location of tire factories would change significantly if one of the possible alternatives was implemented in lieu of the priority product, so transportation impacts (CO ₂ emissions, road wear particles) from the production facility to sales locations should not change.
	Use	Likely	If alternatives can eliminate or reduce the release of 6PPD or another chemical with similar toxicity to susceptible species to the environment, then there would be a material difference in this life cycle segment. Beyond the reported effect of 6PPD on certain salmon species, there are other aspects of the use phase which will need to be considered. One important consideration would be whether an alternative results in

Category	Factor that Is Relevant if Materially Different Between Priority Product and Alternatives	Relevant?*	Basis
			greater or lesser tire wear, potentially resulting in different environmental impact. However, tire wear particle generation likely depends more on driving conditions (<i>i.e.</i> , speed, road surface type), than the antidegradant. Any alternative that could be implemented in a reasonable timeframe would still be rubber-based. The use phase may include storage of the tires when not in use (<i>e.g.</i> , in an attached garage, in the vehicle trunk (for passenger tires), or in a distribution facility.) The low volatility of 6PPD does not indicate significant exposure during storage and an alternative that is more volatile or otherwise migrates out of the tire during storage would not satisfy the goals of having a long-term reservoir of antidegradant in the tire. Thus, it appears unlikely there would be a material difference among an alternative in terms of the storage aspect of tire use but data are limited.
	Operation and maintenance	Unlikely	Tires require little maintenance while in actual use. The maintenance that is required (<i>e.g.</i> , maintaining proper inflation, periodic tire rotation and balancing) would not be expected to change with any of the possible alternatives.
	Waste generation and management	Potentially	This lifecycle segment pertains to manufacturing of the tire. During manufacturing manufacturers cycle excess formulated compound back into the manufacturing process (called rework); this substantially minimizes waste generated during tire production. The ability to continue the rework process is critical for minimizing production waste and will need to be considered for any of the possible alternatives. An alternative antidegradant that impacts processing time or temperature stability could significantly impact the potential for rework.
	Reuse and recycling	Potentially	A significant portion of tires are re-used as fill material or burned for energy (<i>e.g.</i> , in cement kilns) (See Figures 4.1 and 4.2). If possible alternatives alter this situation, there could be a material difference in terms of waste minimization potential. For example, NBC contains the carcinogen nickel which could impact air emissions from cement kilns or use as fill in artificial turf. Possible alternatives that have different environmental mobility (<i>e.g.</i> , greater water solubility) might also lead to a material difference in impact during reuse. One particular consideration for truck and bus tires is retread. An alternative that interferes with the retreading process could substantially increase tire waste because whole truck and bus tires would need to be purchased and discarded more frequently.
	End-of-life disposal	Potentially	About half of passenger tires in California are recycled to energy (<i>i.e.</i> , tire derived fuel) or other uses (<i>e.g.</i> , crumb rubber infill) (CalRecycle, 2023). If tires with alternative antidegradants have a different lifespan this could impact the amount of post-manufacturing tire waste generated and could exceed reuse and recycling capacity. However, consumers will only accept a limited decrease in product lifespan and so an alternative that substantially reduces product lifespan will be rejected.
Adverse Air Quality Impacts**	Would the product bring any changes to emissions of California Toxic Air Contaminants (<i>e.g.</i> , benzene, Cr[VI])?	Unclear	Based on a review of the California Toxic Air Contaminant list (CARB, 2020), neither 6PPD nor any of the possible alternatives are Toxic Air Contaminants. As shown in Table 4.6, nearly all of the possible alternatives have chemicals in their production stream (<i>e.g.</i> , benzene, nickel) that are Toxic Air

Category	Factor that Is Relevant if Materially Different Between Priority Product and Alternatives	Relevant?*	Basis
			Contaminants but the extent to which emissions would increase from increased production of the alternatives is not known.
	CO ₂ emissions	Unclear	LCA exist for tires that describes carbon dioxide (CO ₂) emissions (Dong <i>et al.</i> , 2021; Piotrowska <i>et al.</i> , 2019). However, details related to the contribution of 6PPD or any possible alternative to overall product CO ₂ emissions are lacking. Thus, no data on this factor are available for a comparison.
	HFC emissions	No	As indicated in Table 4.6, HFCs do not appear to be used in production of 6PPD or any of the possible alternatives.
	Methane emissions	Unlikely, but data are limited	Methane is released during fossil fuel extraction and most of the possible alternatives have fossil fuels (oil, natural gas) as part of their production life cycle. Graphene can be produced using methane <i>via</i> vapor deposition. Methane is known to be an input in production of NBC but is presumably consumed and not released to the environment. It is unknown whether methane is associated with the production of amine functionalized lignin or rambutan peel extract, but this seems unlikely.
	Nitrogen fluoride emissions	No	Based on the available production process information for 6PPD and the possible alternatives (Table 4.6), emissions of these chemicals are not expected to be part of the life cycle of the Priority Product or any of the possible alternatives. However, the available data on production process are limited.
	Perfluorocarbon emissions		
	Sulfur hexafluoride emissions		
	Other global warming gas emissions	No	All the ingredients of the Priority Product and possible alternatives are produced (or harvested in the case of rambutan peel) industrially so each involves some CO ₂ emissions. No other greenhouse gases are known to be produced in the product life cycles. Methane is known to be an input in production of NBC but is presumably consumed and not released to the environment.
	Particulate matter emissions	Potentially, in part	Use of tires produces TRWP. TRWP will still be produced if any of the possible alternatives are used in lieu of the Priority Product. Whether the absolute amount of TRWP generated will change is not known although since particles are generated by tires gripping the road and this is an important factor for safety, a large change in particle number seems unlikely. That being said, the reported impact of TRWP, given the appropriate conditions, on certain sensitive species (<i>e.g.</i> , juvenile coho salmon, as reported in laboratory studies) potentially would be reduced if 6PPD is replaced with an alternative without such a reported effect on sensitive species. However, other potential impacts of TRWP (<i>e.g.</i> , other additives) would likely be the same. Thus, the relevance is considered to be "potentially, in part" because, while the emissions themselves are unlikely to change significantly, the impact could be materially different.
	Nitrogen oxide emissions	No	Based on the known production process for 6PPD and the possible alternatives (Table 4.6), emissions of these chemicals are not expected to be part of the life cycle of the Priority Product or possible alternatives. None of the functional ingredients in the Priority Products and alternatives are ozone-depleting substances. A few of the possible alternatives (DOPD, DLTP) have production processes that involve sulfuric acid, which may be produced using sulfur dioxide, but this is not the only method of production and release of sulfur dioxide may not be part of the production process.
	Ozone-depleting substances emissions		
	Sulfur dioxide emissions		

Category	Factor that Is Relevant if Materially Different Between Priority Product and Alternatives	Relevant?*	Basis
	Would the product bring any changes to emissions of compounds that might lead to tropospheric ozone production?	Unclear	Tropospheric ozone is formed by the reaction of solar energy with hydrocarbons and nitrogen oxides. 6PPD and all of the possible alternatives have hydrocarbons in their production chain, and several have nitrogen compounds (nitric acid). Whether compounds contributing to tropospheric ozone formation are emitted during production and whether production occurs in California is unclear.
Adverse Ecological Impacts*	Would the product, its constituents, or its likely breakdown products have any acute or chronic toxicity to impact aquatic, avian, or terrestrial animal or plant organisms or microbes?	Yes	Recent laboratory studies have reported that 6PPD's transformation product 6PPDQ, in certain concentrations, exhibits acute toxicity to certain fish species such as coho salmon. Although toxicity of quinone products of the alternatives is not known with certainty, preliminary data suggests that the quinones of certain other PPDs do not possess the same degree of toxicity to such species. These data were collected in <i>in vitro</i> systems, however and would need to be verified. In terms of other environmental breakdown products of 6PPD and the possible alternatives, data are limited. To the extent that information was found in the ECHA dossiers we examine, as shown in Table 5.10, 6PPD and many possible alternatives have similar breakdown products which do have acute aquatic toxicity (GHS category 1), including p-benzoquinone, p-hydroquinone, and aniline. Data on environmental transformation products for many of the possible alternatives (TMQ, ethoxyquin, DLPTP) are lacking. Graphene would presumably have no transformation products in the environment but could release nano materials which could have an environmental impact.
	Would the product bring changes in population size, reduction in biodiversity, or changes in ecological communities?	Yes	Recent laboratory studies have reported that 6PPD's transformation product 6PPDQ can cause symptoms associated with pre-spawn mortality in certain salmonid species which, among other factors, has the potential to impact the population size of this species. Moreover, reductions in the population size of these salmon species could affect biodiversity. As noted earlier, there is preliminary information suggesting that other PPD antidegradants do not possess this property. It appears unlikely that non-PPD alternatives (<i>e.g.</i> , TMQ, ethoxyquin) can produce these or equivalent effects although this has not been studied.
	Would the product bring changes to the abilities of an endangered or threatened species to survive or reproduce?	Yes	See discussion above.
	Would the product bring changes to deterioration or the loss of environmentally sensitive habitats?	Unclear	6PPD is not known to directly cause habitat deterioration or loss. Along with other factors, laboratory studies have indicated that 6PPDQ can potentially impact populations of coho salmon and other sensitive species. The salmon spawning process is known to be important in transporting nutrients to riverine ecosystems. Thus, while 6PPD and 6PPDQ are not known to directly cause habitat loss or deterioration, there may be an indirect effect. It is unknown whether any of the possible alternatives could impact sensitive habitats since they are not currently used in a manner similar to 6PPD. Alternatives that do not cause pre-spawn mortality of coho salmon or other sensitive species (or which are less potent in this regard) would seem to be preferred alternatives with respect to this relevant factor. If additional agricultural land is required to produce lignin or rambutan peel extract (assuming these are not synthesized chemically), there could be associated habitat loss.

Category	Factor that Is Relevant if Materially Different Between Priority Product and Alternatives	Relevant?*	Basis
	Would the product bring changes that contribute to or cause vegetation contamination or damage?	Unclear	6PPD is not known to directly cause habitat deterioration or loss. This is not stated to be a property of the possible alternatives but these have not been used in as widespread a product as motor vehicle tires. If additional agricultural land is required to produce lignin or rambutan peel extract (assuming these are not synthesized chemically), there could be associated habitat loss.
	Would it bring adverse effects on environments that have been designated as impaired by a California State or federal regulatory agency?	Unclear	6PPD is not known to directly cause habitat deterioration or loss. Along with other factors, laboratory studies have indicated that 6PPDQ can potentially impact populations of coho salmon and other sensitive species. The salmon spawning process is known to be important in transporting nutrients to riverine ecosystems. Thus, while 6PPD and 6PPDQ are not known to directly cause habitat loss or deterioration, there may be an indirect effect. It is unknown whether any of the possible alternatives could impact sensitive habitats since they are not currently used in a manner similar to 6PPD. Alternatives that do not cause pre-spawn mortality of coho salmon or other sensitive species (or which are less potent in this regard) would seem to be preferred alternatives with respect to this relevant factor. If additional agricultural land is required to produce lignin or rambutan peel extract (assuming these are not synthesized chemically), there could be associated habitat loss.
	Would it result in biological or chemical contamination of soils?	Unclear	6PPD does not appear to affect soils during its use in tires; tire wear particles generally enter the aquatic environment or remain on roadways. The extent to which 6PPD/6PPDQ can migrate to soils from use of tire rubber as fill (<i>e.g.</i> , in artificial turf) is not well studied. Any alternative would presumably have the same potential if tires containing it were used in a similar manner. As noted earlier, any alternative to 6PPD would have to migrate through tire rubber which would seem to indicate a similar ability to migrate from rubber infill to soil.
	<p>Any other adverse effects, as defined in Section 69401.2(a) (CalDTSC, 2012a), for environmental hazard traits and endpoints specified in Article 4 of Chapter 54, as follows:</p> <ul style="list-style-type: none"> ▪ Domesticated animal toxicity ▪ Eutrophication ▪ Impairment of waste management organisms ▪ Loss of genetic diversity (including biodiversity) ▪ Phytotoxicity ▪ Wildlife developmental impairment 	Potentially, in part	Because of the reported phenomenon of pre-spawn mortality (Scholz <i>et al.</i> , 2011), 6PPDQ has the potential to affect coho reproductive success. Certain studies suggest it may affect coho development (Greer <i>et al.</i> , 2023b). DTSC’s Product-Chemical Profile for 6PPD in motor vehicle tires (CalDTSC, 2022) also states that published studies also suggest 6PPDQ could have an impact on the following concerns: genetic diversity, wildlife development, reproduction, survival and growth. Preliminary <i>in vitro</i> data suggest some of the possible alternatives do not have this effect. However, data are incomplete on the potential for these possible alternatives to have other adverse ecological impacts. Literature searches with “6PPD” and any of the following: “eutrophication”, “domestic animals”, “waste management”, and “phytotoxicity” did not indicate studies reporting an effect of 6PPD on these concerns. Whether possible alternatives could have such concerns will be investigated as part of Stage 2 with the refined alternative list.

Category	Factor that Is Relevant if Materially Different Between Priority Product and Alternatives	Relevant?*	Basis
	<ul style="list-style-type: none"> ▪ Wildlife growth impairment ▪ Wildlife reproductive impairment ▪ Wildlife survival impairment <p>Evidence for environmental hazard traits (<i>i.e.</i>, from standard aquatic and terrestrial toxicity testing, research-based investigations, mechanistic evidence from cell-based or whole organism-based assays showing perturbations of known physiological, biochemical, or other pathways, or evidence from quantitative structure activity relationship programs).</p>		
Adverse Soil Quality Impacts*	Would the product impact soil compaction or other soil structure changes?	No	Given the primary use of the product (driving on engineered roadways) it would not be expected that effects on the soil physical characteristics listed would be materially different among possible alternatives.
	Would the product impact soil erosion?		
	Would the product cause loss of organic matter in soil?		
	Would the product cause soil sealing?		
	Would the product be expected to directly enter the municipal storm sewer systems (<i>e.g.</i> , car wash detergents)?	No	6PPD and its possible alternatives would all be expected to be present in tire road wear particles and enter stormwater sewers during precipitation events. Since 6PPD and all of the alternatives are similar in this regard, the factor would not be materially different and is therefore considered not relevant.
	Would the product bring any increase in biological oxygen demand within the water system?	No	Neither 6PPD nor any of the possible alternatives have been demonstrated to have the potential to affect the growth of biological organisms in a way that would alter biological oxygen demand.
	Would the product bring any increase in chemical oxygen demand within the water system?	Unlikely	As antioxidants, it can be expected that all alternatives would have the <i>potential</i> to affect chemical oxygen demand. Whether such effects are materially relevant (given the relatively low concentrations of these chemicals detected in surface water bodies) has not been investigated. It seems logical to expect that other chemicals, present at higher concentrations, would be more likely to impact chemical oxygen demand.
	Would the product bring any increase in the temperature of water systems?	No	Neither 6PPD nor any of the possible alternatives have the potential to alter the temperature of water systems. Key determinants of water temperature in streams are the source of incoming waters, the speed and depth of the water, and the degree of vegetative cover affecting sunlight. None of these would be affected by 6PPD or its possible alternatives.
Would the product bring any increase in total dissolved solids in water systems?	Potentially	Total dissolved solids (TDS) indicates the amount of inorganic and organic chemicals present as molecular, ionized, or colloidal particles in water. Some of the possible alternatives are inorganic and the alternatives	

Category	Factor that Is Relevant if Materially Different Between Priority Product and Alternatives	Relevant?*	Basis
			vary in their water solubility. It is possible that this property could differ among the possible alternatives although whether it would be materially different is unclear.
	Increase in California CWA priority pollutants	No	Based on a review of the California Clean Water Act (CWA) Hazardous Substances, Priority Pollutants, and Toxic Pollutants lists (UL LLC, 2020) neither 6PPD nor any of its possible alternatives are present on these lists. The same applies to the main transformation products, to the extent that these are known.
	Increase in California CWA pollutants		
Adverse Water Quality Impacts*	Increase in chemicals with drinking water MCLs	No	Based on a review of the relevant regulations (22 CCR § 64431, § 64444, and § 64449) neither 6PPD nor any of its possible alternatives have drinking water MCLs. The same applies to the main transformation products of 6PPD and the possible alternatives, to the extent that such transformation products are known.
	Increase in chemicals with drinking water notification levels	No	Based on a review of the California guidance (CalSWRCB, 2020) neither 6PPD nor any of its possible alternatives have drinking water notification levels. The same applies to the main transformation products of 6PPD and the possible alternatives to the extent that such are known.
	Increase in chemicals with drinking water public health goals	No	Based on a review of the relevant regulation (CalOEHHA, 2019b) neither 6PPD nor its possible alternatives have drinking water public health goals (PHG).
	Exceedance of a standard relating to the protection of the environment	No	The consortium members are not aware of any material difference between 6PPD and any of the possible alternatives with respect to this relevant factor.
Public Health Impacts*§	Acute mammalian toxicity [Not included as a SCP hazard trait but included at preparer's discretion]	No	As shown in Table 5.1, there are slight differences in acute toxicity across the possible alternatives. Some possible alternatives have a higher acute toxicity than 6PPD (GHS category 3 <i>versus</i> 4) and many (<i>e.g.</i> , 7PPD, DPPD, 6QDI, Durazone 37, graphene) are not classified under GHS nor classified for acute mammalian toxicity. These differences are not likely to have a significant bearing on the choice of alternative (<i>i.e.</i> , there are no GHS acute toxicity category 1 or 2 alternatives) There are also many alternatives with data gaps for this factor.
	Carcinogenicity	Potentially	As shown in Table 5.1, 6PPD is GHS not classified for carcinogenicity. A number of possible alternatives are similarly not classified (7PPD, DTPD, DLTP, Durazone 37). Several possible alternatives (<i>i.e.</i> , TMQ oligomer, N-phenyl-2-naphthylamine, NBC) are classified as GHS category 2 for carcinogenicity. There are many possible alternatives with data gaps for this factor.
	Developmental toxicity	Yes	As shown in Table 5.1, 6PPD is has a high hazard classification (category 1B) for reproductive and developmental toxicity. A number of PPDs have similar classification (although some of these are based on using 6PPD as a surrogate). A few possible alternatives have low potential for reproductive and developmental toxicity (<i>i.e.</i> , GHS not classified). There are many possible alternatives with data gaps for this factor.
	Reproductive toxicity		
	Cardiovascular toxicity	Potentially	As shown in Table 5.2, 6PPDQ has been suggested to affect the cardiovascular system in coho salmon by affecting vascular permeability, however, there are many data gaps and no relevant observations have been made in mammalian species. A few possible alternatives (<i>e.g.</i> , NBC, DLTP) have been reported to affect the cardiovascular system.

Category	Factor that Is Relevant if Materially Different Between Priority Product and Alternatives	Relevant?*	Basis
	Dermatotoxicity (including skin sensitization)	Yes	As shown in Table 5.1, 6PPD is not classified for skin irritation or corrosion (<i>i.e.</i> , low hazard). Most possible alternatives are either similarly not classified or have a data gap for this factor. Two possible alternatives score worse than 6PPD for this factor (CCPD and N-phenyl-2-naphthylamine). However, 6PPD and several other PPDs (<i>e.g.</i> , 7PPD, Durazone 37) are classified as category 1 skin sensitizers (Table 5.1). Several non-PPD alternatives are GHS not classified for skin sensitization (TMQ oligomer, NBC, graphene, Irganox 1620). There are many chemicals with data gaps.
	Ocular toxicity	Yes	As shown in Table 5.1, 6PPD is not classified for eye irritation (ECHA) or classified as category 3 (Ecology GreenScreen). A number of possible alternatives are GHS category 2 for eye irritation (<i>e.g.</i> , 6QDI, CCPD, NBC, N-phenyl-2-naphthylamine). A number of possible alternatives (<i>e.g.</i> , 77PD, DTPD, TMQ oligomer, Durazone 37, graphene) score more favorably. There are many possible alternatives with data gaps for this factor.
	Organ toxicity [Not included as a SCP hazard trait but included at preparer's discretion]	Yes	As shown in Table 5.1, 6PPD is classified as category 2, moderate hazard, for repeated dose systemic toxicity (which encompasses organ toxicity) as evaluated by ToxServices. However, in the EU ECHA dossier, it is "not classified." A number of the 6PPD alternatives (7PPD, NBC, ethoxyquin, N-phenyl-2-naphthylamine) have similar or worse scores. A number are GHS not classified for this factor and so appears to have lower hazard than 6PPD (<i>e.g.</i> , DPPD, DTPD, DLTP, Durazone 37, graphene). There are a number of data gaps.
	Endocrine toxicity	Potentially	As shown in Table 5.1, the picture is mixed. None of the possible alternatives are listed as endocrine disruptors in the EU. 6PPD and a few possible alternatives (7PPD, IPPD, 6QDI and ethoxyquin) were listed as having moderate evidence of endocrine activity in the Ecology GreenScreens. Many possible alternatives have data gaps for this factor.
	Epigenetic toxicity	No	Epigenetic toxicity refers to the ability to alter gene expression without necessarily changing gene structure. In reviewing toxicity summaries for the possible alternatives, we found no indication that any of the possible alternatives exerted epigenetic effects. However, such effects are not often studied.
	Genotoxicity	Potentially	As shown in Table 5.1, 6PPD is not classified for genotoxicity/mutagenicity. All possible alternatives but one are either similarly not classified or have a data gap for this factor. DPPD is reported to be GHS category 2 (moderate hazard) for this factor.
	Hematotoxicity	Potentially	As shown in Table 5.2, 6PPD has been found to exert hematotoxicity at high doses in rats in some studies. A number of other PPDs (IPPD, DPPD, DAPD) and non PPDs (NBC, ethoxyquin, DLTP) have also shown hematotoxic effects. Data for a number of chemicals (<i>e.g.</i> , TMQ, graphene) are lacking.
	Hepatotoxicity and digestive system toxicity	Potentially	As shown in Table 5.2, 6PPD has given some evidence of adverse effects in the liver in rodents. A few of the possible alternatives (<i>e.g.</i> , polymerized TMQ, ethoxyquin) have also shown adverse effects on the liver. Note that effects on liver weight alone are not considered adverse but may be considered adaptive.

Category	Factor that Is Relevant if Materially Different Between Priority Product and Alternatives	Relevant?*	Basis
	Immunotoxicity	Yes	Other than being a dermal sensitizer, 6PPD is not known to be an immunotoxicant. Data gaps exist for most of the possible alternatives; however, most of the phenylene diamine possible alternatives are dermal sensitizers. It should be noted that dermal sensitization is also considered under another relevant factor in this table (<i>i.e.</i> , dermatotoxicity). A few (NBC, DAPD) have reports of changes in the weight or size of immune system related organs but no more direct indications of adverse effects.
	Musculoskeletal toxicity	Potentially	6PPD is not noted to cause musculoskeletal toxicity. No relevant information was found for any of the possible alternatives except NBC, which was noted to cause degeneration of skeletal muscle in rats. Effects on skeletal development during gestation are addressed under Developmental Toxicity.
	Nephrotoxicity and other toxicity to the urinary system	Potentially	6PPD is not reported to cause adverse effects on the kidney. Most possible alternatives similarly were not reported to cause adverse kidney effects. Ethoxyquin and N-phenyl-1-naphthylamine have been reported to cause kidney degeneration in rats.
	Neurodevelopmental toxicity	Potentially	6PPD is not reported to cause adverse neurological effects either in adults or juvenile animals. Most possible alternatives have data gaps for this factor. NBC and ethoxyquin and are reported to have caused adverse neurological effects in experimental animals.
	Neurotoxicity		
	Ototoxicity	No	No data were located which indicated ototoxic (hearing related) effects for 6PPD or any of the possible alternatives.
	Reactivity in biological systems	Potentially	DTSC has stated that 6PPDQ is reactive in biological systems as part of the Agency's Priority Product Profile. We believe that the effects of 6PPDQ reported by some researchers are more appropriately and precisely described by other relevant factors (<i>e.g.</i> , those related to aquatic toxicity). That being said, preliminary data discussed in section 5 suggests that at least some other PPDs and their quinone transformation products may have differential toxicity to coho salmon. While all molecules are reactive at some dose in biological systems, it appears likely that the toxicity will differ. More data are needed to fully evaluate this endpoint.
	Respiratory toxicity (including respiratory sensitization)	Yes	6PPD and several other PPDs are classified in the Ecology GreenScreens as respiratory sensitizers based primarily on a structural alert (Table 5.1). There are many chemicals with data gaps, although a few possible alternatives are not classified for respiratory sensitization (<i>i.e.</i> , low hazard) such as Durazone 37. No data were located which indicated any other adverse respiratory effects for 6PPD or any of the possible alternatives. Potential effects of 6PPDQ on respiration in coho salmon are noted in CalDTSC's Priority Product Profile (CalDTSC, 2022).
	Evidence for other toxicological hazard traits	No	In our review of hazard data, we did not discover evidence for other toxicological hazard traits.
	Exceedance of an enforceable California or federal standard related to public health	No	To the best of our knowledge, use of the Priority Product or any of the possible alternatives will not involve intentional exceedance of such a standard, other than the ones already addressed elsewhere in this table.

Category	Factor that Is Relevant if Materially Different Between Priority Product and Alternatives	Relevant?*	Basis
Waste and End-of-Life Effects*	Would the product bring any change to the volume or mass of the waste materials and byproducts generated during the life cycle?	Unclear	Because the possible alternatives are all replacements for 6PPD in vehicle tires and represent only a small fraction of the mass of a tire, a materially relevant impact on the amount of waste or byproducts produced is not foreseen. However, as noted above, tire manufacturers rely on reusing some production waste (re-work) in the tire manufacturing process to minimize waste generation. An alternative that alters that ability could result in more waste generation but the extent to which that might occur is not currently known.
	Would the product need any special handling to mitigate adverse impacts resulting from the waste materials generated during the life cycle?	Unclear	At this time, it is not expected that there will be any different requirements for waste material handling from any of the possible alternatives. However, as noted above, their production process (certainly at scale) is not well understood. This will be explored in the Stage 2 AA.
	Effects on solid waste or wastewater disposal or treatment	Unclear	At this time, it is not expected that there will be any different requirements for waste material handling from any of the possible alternatives as it related to waste disposal. However, as noted above, their production process (certainly at scale) is not well understood. This will be explored in the Stage 2 AA.
	Effects on discharge(s) or disposal(s) to storm drains or sewers adversely affecting wastewater or storm water treatment facilities	Unclear	At this time, it is not expected that there will be any different impacts on wastewater or stormwater treatment facilities. It is expected that all production facilities operate with water discharge permits which might need to be modified to address production of tires with a new antidegradant.
	Release to the environment	Unclear	Consortium members are not aware of any other factors associated with releases to the environment that would be associated with any of the possible alternatives.
Environmental Fate*	Aerobic and anaerobic half-lives of the product, its constituents, or its likely breakdown products	Unclear	No information on the aerobic or anaerobic half-lives could be found in EpiSuite or ECHA dossiers for 6PPD and the possible alternatives. Although we are aware of specific studies related to the aerobic and anaerobic half-lives of 6PPDQ, we are unaware of any data that exists for the potential alternatives, making comparisons impossible. This relates to the factor of persistence, discussed below.
	Aqueous hydrolysis half-life of the product, its constituents, or its likely breakdown products	Unclear	No information on hydrolysis rate constant could be found in EpiSuite or ECHA dossiers.
	Atmospheric oxidation rate	Unclear	No information on hydrolysis rate constant could be found in EpiSuite or ECHA dossiers. However, see Table 5.9 regarding the environmental half-life in air which is influenced by atmospheric oxidation rate. Although there are differences among 6PPD and possible alternatives for this property, they are not considered materially relevant since the primary concern is migration of 6PPD to surface water. All values are less than 1.0. 6PPD and most possible alternatives have very low vapor pressures suggesting limited impacts on air. While 6PPD associated with dust has been measured in air it is unclear how this would be affected by atmospheric processes since the chemical is contained within the particle substrate.
	Bioaccumulation of the product, its constituents, or its likely breakdown products	Yes	As shown in Figure 5.11, neither 6PPD nor any of the possible alternatives are listed as persistent, bioaccumulative or toxic. 6PPD and the possible alternatives do vary substantially in terms of the bioaccumulation potential. For example, as shown in table 5.3, while 6PPD, DPPD, 7PPD, DTPD are considered bioaccumulative based on California criteria, other possible alternatives (IPPD, TMQ oligomer,

Category	Factor that Is Relevant if Materially Different Between Priority Product and Alternatives	Relevant?*	Basis
			ethoxyquin, and DLTP) are not. There are a number of chemicals with data gaps. Given that 6PPD and 6PPDQ are of concern for toxicity to certain fish species, bioaccumulation potential should be considered a relevant criterion if there is a difference among possible alternatives.
	Mobility in environmental media	Yes	See below regarding water solubility, lipid solubility, log k_{ow} , etc. There is a difference in ability to move through environmental media across the possible alternatives. Given that the key concerns regarding 6PPD are effects on certain fish species, environmental mobility is a relevant factor if there are differences among the possible alternatives.
	Persistence	Yes	6PPD and the PPD related alternatives are either considered persistent or have data gaps. NBC, TMQ oligomer, and ethoxyquin are considered persistent although DLTP is not.
	Photodegradation	Unclear	Data for the photolysis rate constant is lacking for most of the possible alternatives. Moreover, given the low vapor pressure of the possible alternatives, it does not appear that free chemicals will be present in the air. Whether photolysis is a relevant mechanism for chemicals in tire wear particles is unknown.
Materials and Resource Consumption	Impacts on consumption of renewable resources, including energy and raw materials, throughout the product life cycle	Potentially	Very few inputs to the production of 6PPD and its possible alternatives as renewable resources. Tires do contain some renewable resource content (natural rubber) and whether this would change with different antidegradants (particularly non PPD antiozonants) is unclear. It is unknown how renewable energy requirements might differ for the possible alternatives. For electric vehicles, which have an increasing share of the vehicle market in California, consumption of renewable energy is important, and this could be affected by rolling resistance and vehicle energy efficiency per mile traveled. This could be affected by the possible alternatives if they affect rolling resistance.
	Impacts on consumption of non-renewable resources, including petroleum, coal, metals, minerals, and other finite resources, throughout the product life cycle	Potentially	As shown in Table 4.5, all of the possible alternatives appear to have some fossil fuel or otherwise non-renewable ingredients. Whether there is a quantitative difference among possible alternatives that is materially different is unclear. As noted above, possible alternatives that could affect the rolling resistance could impact consumption of non-renewable energy sources.
Physicochemical Properties*	Do the product or the alternatives exhibit oxidizing properties that facilitate combustion?	No	6PPD and all of the possible alternatives are being used as antidegradants, and ideally have both antioxidant and antiozonant properties. Therefore, the alternatives would likely inhibit rather than facilitate combustion.
	Do the product or the alternatives exhibit explosivity?	Unlikely	Based on the available ECHA REACH dossiers of the chemicals, none of the products exhibit this property (ECHA, 2020). However, for a number of possible alternatives, information on explosivity is not available.
	Do the product or the alternatives exhibit flammability?	Unlikely	Based on the available ECHA REACH dossiers of the chemicals, none of the products exhibit this property (ECHA, 2020). However, for a number of possible alternatives, information on flammability is not available.
	Do the product and alternatives have different physical states?	Potentially	Some alternatives, like 6PPD, are solids whereas others are viscous liquids. However, this difference is not expected to be materially relevant to the impact of the chemical on humans or the environment. It could be an important difference in terms of technical feasibility because current tire production processes are designed to work with solid antidegradant.

Category	Factor that Is Relevant if Materially Different Between Priority Product and Alternatives	Relevant?*	Basis
	Molecular weight	Yes	As shown in Table 5.9, the molecular weights range broadly across the possible alternatives. Molecular weight influences migration of the molecule in tire rubber and is thus an important factor in performance.
	Density	Unclear	Density information is lacking for many possible alternatives. Most have densities around 1 g/mL. Density could be important in terms of technical feasibility of incorporating the chemical into rubber compound.
	Vapor pressure	Potentially	As would be expected for compounds with high molecular weights, 6PPD and the possible alternatives all have low vapor pressures (maximum 1.56 E-3 mmHg at 25°C). Vapor pressure would not be expected to constitute a materially relevant difference in terms of performance or environmental impact. In terms of technical feasibility, vapor pressure is important because the antidegradant has to survive the high temperatures of the tire manufacturing process without excessive loss.
	Melting point	Potentially	As noted above, some of the possible alternatives are solids (like 6PPD) and some are liquids. The physical state could impact the technical feasibility of incorporation into rubber compound but should not affect environmental impacts.
	Boiling point	Potentially	As shown in Table 5.9, all of the possible alternatives have high boiling points (the lowest, ethoxyquin is 123-125°C). Boiling point would not be expected to be a materially relevant difference in terms of either technical feasibility or environmental impact.
	Flash point	Potentially	Flash point is not one of the SCP mandated relevant factors. This property is materially relevant however, because it relates to manufacturing safety concerns with high temperature processes. This is captured in the flammability endpoint included in Table 5.3, where a number of possible alternatives have data gaps.
	Water solubility	Yes	As shown in Table 5.9, water solubility among the various possible alternatives varies by more than 10 orders of magnitude. Water solubility will have a significant bearing on movement of the chemical from tire wear particles through the environment.
	Lipid solubility	Yes	As shown in Table 5.9, the log K_{ow} (an indicator of lipid solubility) varies substantially among the possible alternatives. Lipid solubility will have a significant impact on where in the environment the chemical will partition.
	Octanol-water partition coefficient (log K_{ow})	Yes	
	Organic carbon partition coefficient (K_{oc})	Yes	As shown in Table 5.9, the K_{oc} varies substantially among the possible alternatives. K_{oc} will have a significant impact on where in the environment the chemical will partition (<i>e.g.</i> , water <i>versus</i> sediment).
	Sorption coefficient for soil and sediment	Unclear	No data could specifically be located for this factor but see the discussion above for K_{oc} .
	Octanol-air partition coefficient (K_{oa})	Unclear	No data on this parameter could be located. See below regarding Henry's Law constant.
	Diffusivity in air and water	Potentially	As shown in Table 5.9, this parameter varied relatively modestly across the possible alternatives and is therefore unlikely to result in a material difference among them.
Henry's Law constant	Yes	This parameter measures the tendency of a chemical to partition between water <i>versus</i> air. This parameter varies substantially among the possible alternatives and would be important in assessing environmental mobility of the chemical. Its relevance is somewhat linked to both water solubility and vapor pressure.	

Category	Factor that Is Relevant if Materially Different Between Priority Product and Alternatives	Relevant?*	Basis
	Redox potential	Unclear	As shown in Table 5.9, redox potential data are available for 6PPD and a few of the possible alternatives. The values are all fairly similar, so this is not expected to make a material difference among possible alternatives where such information is available. Information is lacking, however, for many of the possible alternatives.
	Photolysis rates	Unclear	As shown in Table 5.9, there is a significant difference in photolysis potential among 6PPD and the possible alternatives. However, all have very low vapor pressures and would not be expected to be present in the atmosphere to an appreciable extent. However, all might be present in airborne dust where the impact of photolysis is not known.
	Hydrolysis rates	Unclear	As shown in Table 5.9, no data on hydrolysis rate constants for 6PPD nor any of the possible alternatives could be located.
	Dissociation constants	Unclear	Dissociation constant data were only located for a few of the possible alternatives. The available data suggest a limited potential for dissociation and therefore this factor is not believed to be materially relevant.
	Reactivity, including electrophilicity	Yes	The products are all chemically reactive as part of their function. To perform adequately, they must be chemically reactive, and the degree of reactivity is important to their antidegradant function in the tire.
Product Function and Performance*	Are there material differences in terms of the useful life of the product?	Potentially	It is possible that a 6PPD alternative that is not as effective could result in a shorter useful life for the product. This would have negative impacts on raw materials and energy consumption during production, waste generation, consumer costs and potentially consumer safety (if consumers replace tires less frequently due to cost). Thus, there are very strong incentives not to accept alternatives that result in a short product life.
	Are there material differences in terms of the function and performance of the product?	Potentially	It is the position of the consortium members that tires must perform in a manner that is safe and consistent with both federal regulations and company product stewardship requirements. An alternative that does not have comparable function and performance as 6PPD would not be acceptable.
	Are there material differences in terms of the functional acceptability of the product?	No	It is the position of the consortium members that any 6PPD alternative must function comparably to 6PPD as an antidegradant.
	Are there material differences in terms of the technical feasibility of the product?	Potentially	There is no alternative that will be a "drop in" replacement for 6PPD. Most alternatives will require modification of the tire formulation and/or the tire production process (e.g., balancing processing time vs curing rate or scorch time). The extent of modification required will likely vary considerably among the possible alternatives and will have to be investigated through production process research.
Economic Impacts*	Will the product and its alternatives have a different cost to consumers or other users?	Potentially	It is possible that the use of a possible 6PPD alternative in tires could have some effect on the cost of the product. There will likely be substantial costs for new production equipment as well as product testing required by law or company product stewardship specifications which would have to be reflected in the cost of the product. Since many of the possible alternatives are not commercially produced at scale, it is unclear how large that difference in cost could be. This will be addressed more fully in Stage 2.

Notes:

6PPD = N-(1,3-Dimethylbutyl)-N'-phenyl-p-phenylenediamine; 6PPDQ = N-(1,3-Dimethylbutyl)-N'-phenyl-p-phenylenediamine quinone; 6QDI = N-1,3-Dimethyl Butyl-N'-Phenyl Quinone Diamine; 7PPD = N-(1,4-Dimethylpentyl)-N'-phenyl-p-phenylenediamine; AA = Alternatives Analysis; CalDTSC = California Department of Toxic Substances Control; CARB = California Air Resources Board; CO₂ = Carbon Dioxide; DAPD = Diaryl-p-phenylene diamine; DLTDP = Dilauryl thiodipropionate; DLTP = Dilauryl thiodipropionate; DOPD = 4,4'-Dioctyldiphenylamine; DPPD = N,N'-Diphenyl-p-phenylenediamine; ECHA = European Chemicals Agency; EU = European Union; GHS = Globally Harmonized System; HFC = Hydrofluorocarbon; IPPD = N-Isopropyl-N'-phenyl-p-phenylenediamine; LCA = Life Cycle Assessment; MCL = Maximum Contaminant Level; NBC = Nickel dibutyldithiocarbamate; PPD = Paraphenylene Diamine; RE = Responsible Entity; REACH = Registration, Evaluation, Authorisation, and Restriction of Chemicals; SCP = Safer Consumer Products; TMQ = Poly(1,2-dihydro-2,2,4-trimethyl-quinoline); TRWP = Tire and Road Wear Particles; US EPA = United States Environmental Protection Agency; VOC = Volatile Organic Compound.

* Whether a factor was considered relevant to drawing a distinction between possible alternatives and candidate chemical in the Priority Product was described using five terms. The terms "yes" and "no" were used when the available data indicated a clear material difference would be expected or is obvious. The terms "potentially" and "unlikely" were used when the available data were too limited to be fully confident on whether a material difference can be expected but the available data leaned towards one direction (*i.e.*, towards either yes or no but not reliably). Finally, the term "unclear" was used when data were not available to give an indication of whether a factor would be relevant or not.

** For these relevant factors, we consider the impacts of the Priority Product and possible alternatives but not of chemicals upstream in their product lifecycle.

§ Public health impacts relate to 6PPD and possible alternatives. Hazards of 6PPDQ are not included because data for this chemical are limited and data for the quinone products of possible alternatives are unavailable, making comparison impossible.

Safer Consumer Products (SCP) regulations: CalDTSC (2013) (22 CCR § 69505.5).

Table 4.5 Life Cycle Elements Considered in Evaluating Potential Exposures

Category	Element	Relevant?*	Basis
Chemical Quantity Information	Would the alternative change the quantities of the chemical(s) of concern or other replacement chemicals necessary to manufacture the product?	Unclear	For possible alternatives to 6PPD as an antidegradant, data are not yet available to determine how the quantity required per tire might change. It is expected that the amount of antiozonant will not change substantially (<i>e.g.</i> , by several fold) but this remains to be seen.
	Would the alternative change the quantities of the chemical(s) of concern or other replacement chemicals placed into the stream of commerce in California?	Unclear	
Market Presence of Product	Would the alternative change statewide sales of the product by volume?	Potentially	Since all possible alternatives are replacements for 6PPD, tire sales volume and number of units should not change unless costs significantly increase or unless the use of the alternative decreases the life of the tire (<i>i.e.</i> , increasing the wear or aging rate), which would require more frequent replacement. Also, an alternative that affects retread potential could require larger sales of new truck and bus tires.
	Would the alternative change statewide sales of the product by number of units?		
	Would the alternative change the intended product use(s), and types and age groups of targeted customer base(s)?	No	Tires would be used in the same manner and by the same type of individuals. Tires are not used in different ways by different segments of the population.
Occurrence or Potential Occurrence of Exposure	Will there be a difference in occurrence or potential occurrence of exposure to Candidate Chemicals in the product?	Potentially	If the selected alternative is a PPD, it may not affect exposure to candidate chemicals (while still having an improved hazard profile for fish species of concern). If another, non-PPD alternative is selected, this could change the potential for candidate chemical exposure during certain phases of the life cycle, although details are lacking about how these possible alternatives would be handled and managed.
Household and Workplace Presence	Will the product be used in the home?	Potentially	Tires may be stored in the home, but it is abrasion of tires by roads which results in the release. It is possible that volatilization of the antidegradant could result in migration to air. Although DTSC has indicated that the vapor pressure of 6PPD is negligible (DTSC, 2023), some of the alternatives may have relatively greater volatility. Thus, storage in the home (<i>e.g.</i> , the garage) could potentially be a relevant factor for some of the alternatives.
	Will the product be used in the workplace?	Yes	Tires are used on vehicles used during work (<i>e.g.</i> , cars used for work, and trucks and buses). However, that use involves minimal exposure for the worker because the tires are not located where the work is located. In some cases, tires are used in tire warehouses and dealerships where this is potential for exposure. The extent of exposure is unknown.
Potential Exposure	Are there differences in the manufacturing, use, storage, transportation, waste, or end-of-life management of the product and alternatives?	Unclear	Details about how tires could be manufactured with the selected alternative(s) are lacking. It is assumed some differences in manufacturing would be required but the degree of change is unknown at this time. Refer to Table 4.6 for the lifecycle step-by-step consideration.

Category	Element	Relevant?*	Basis
	Is the product manufactured, stored, or transported through California but not used in California?	No	The product is used in California.
	Is the product an intermediate product used to manufacture an exempted product?	No	No, 6PPD is used to manufacture tires which are not an exempted product.
	Does the product have household use?	No	No, the product is not used inside the home. Tires may be stored in the home (e.g., garage) but it is abrasion of tires by roads which results in the release. Thus, even if stored in the home there is minimal potential for exposure.
	Does the product have recreational use?	No	The priority product is not intended for recreational use. At end of life, the product may be used as crumb rubber fill in recreational fields.
	Are there sensitive subpopulations that use the product and alternatives?	Yes	Sensitive populations include workers, sensitized individuals, children, the elderly, and pregnant women. These individuals do use vehicles containing tires in a manner similar to the general population. However, their use does not result in particular exposure. If the use of spent tires as crumb rubber fill is considered, there may be particular types of exposure to certain populations. However, it is not clear if use of spent tires for this purpose falls within the designation of the priority product or whether such materials would need to be designated as their own priority product.
	Is the product used in homes?	No	No, the product is not used inside the home. Tires may be stored in the home (e.g., garage) but it is abrasion of tires by roads which results in the release. Thus, even if stored in the home there is minimal potential for exposure.
	Is the product used in schools?	No	Tires are not intended for use inside schools. School buses have tires, but this use does not appear related to the intention of this relevant factor.
	Is the product used in workplaces?	Yes	Tires are used on vehicles used during work (e.g., cars used for work, and trucks and buses). However, that use involves minimal exposure for the worker because the tires are not located where the work is located. In some cases, tires are used in tire warehouses and dealerships where this is potential for exposure. The extent of exposure is unknown.
	Is the product used in other unusual locations?	Yes	Spent tires are used in various applications including energy production, retaining walls, marine applications, and as noted above, as an artificial turf component.
	Is there a difference in the frequency, extent, level, and duration of exposure potential for the product and its alternatives during use?	Unclear	Tires will be used in the same manner regardless of whether 6PPD or an alternative is used. If the possible alternative lacks 6PPD/6PPDQ toxicity to certain fish species, the impact of the exposure will be different.
	Is there a difference in the frequency, extent, level, and duration of exposure potential for the product and its alternatives at end-of-life?	Unclear	At this time, it is unclear what the end-of-life implications of 6PPD alternatives are for the end-of-life stage. This will be further explored in Stage 2.
Potential Exposure	Is there a difference in how the candidate chemical is contained within the product and its alternatives?	Potentially	It is anticipated that most possible alternatives would be non-bound in the polymer structure so as to be able to migrate through the tire as needed. Graphene is one exception as it will not migrate through the rubber matrix.

Category	Element	Relevant?*	Basis
	Is there a difference in terms of engineering and administrative controls to reduce exposure among the product and its alternatives?	Unclear	To date, we have not identified any engineering or administrative controls involved in any of the possible alternatives being evaluated.
	Is there a difference in the potential of the candidate chemical and degradation products to release into, accumulate in, and persist in the environment?	Yes	As noted in Table 5.9, the possible alternatives have different physical and chemical properties that could impact their ability to be released into, accumulate in, and persist in the environment.

Notes:

6PPD = N-(1,3-Dimethylbutyl)-N'-phenyl-p-phenylenediamine; DTSC = Department of Toxic Substances Control; PPD = Paraphenylene Diamine.

* Whether a factor was considered relevant to drawing a distinction between possible alternatives and candidate chemical in the Priority Product was described using five terms. The terms "yes" and "no" were used when the available data indicated a clear material difference would be expected or is obvious. The terms "potentially" and "unlikely" were used when the available data were too limited to be fully confident on whether a material difference can be expected but the available data leaned towards one direction (*i.e.*, towards either yes or no but not reliably). Finally, the term "unclear" was used when data were not available to give an indication of whether a factor would be relevant or not.

Table 4.6 Production Process Chemistry for 6PPD and Possible Alternatives

Chemical	CAS No.	Production Process	Precursor Fossil Fuel Based?	Possible Chemicals Involved Across Lifecycle
6PPD	793-24-8	<p>6PPD is produced <i>via</i> the reduction of either P-nitro- or P-nitrosodiphenylamine to form P-aminodiphenylamine, followed by reaction with methyl isobutyl ketone (MIBK) and hydrogenation over a catalyst (PubChem). The former is produced by the by reaction of an alkyl ether of 4-nitrosophenol with aniline (PubChem). MIBK is derived from acetone <i>via</i> the intermediate mesityl oxide. The key ingredients are therefore 4-nitrosophenol, aniline, and acetone.</p> <p>Acetone is produced in multiple ways including oxidation of cumene; dehydrogenation or oxidation of isopropyl alcohol with metallic catalyst; vapor-phase oxidation of butane; by-product of synthetic glycerol production. Aniline is produced from nitrobenzene, which is itself produced by reaction of benzene with forms of nitric acid. Nitrosophenol is produced by the reaction of nitrous acid on phenol; phenol itself is produced by oxidation of cumene.</p> <p>The base ingredients are therefore hydrocarbons such as cumene, benzene, and butane as well as various catalysts and reagents (<i>e.g.</i> , acids).</p>	Yes. Cumene, benzene, butane, and subsequent chemicals in the production chain are all likely derived from fossil fuel sources.	acetone aniline benzene butane cumene glycerol isopropyl alcohol mesityl oxide metallic catalysts methyl isobutyl ketone P-aminodiphenylamine nitric acid nitrobenzene P-nitrodiphenylamine P-nitrosodiphenylamine 4-nitrosophenol nitrous acid phenol
7PPD (N-(1,4-dimethylpentyl)-N'-phenyl-p-phenylenediamin)	3081-01-4	No PubChem data on manufacturing but is likely to be similar to 6PPD with the use of different isomers. Likely to have the same impact on raw material requirements.	Yes, expected to be similar to 6PPD.	Yes, expected to be similar to 6PPD.
IPPD (N-isopropyl-N'-phenyl-p-phenylenediamine)	101-72-4	<p>Reaction of p-chloronitrobenzene with aniline to yield p-nitrodiphenylamine which is reductively alkylated with acetone over a nickel/chromium catalyst.</p> <p>Chloronitrobenzenes are produced by nitration of chlorobenzene which is itself produced by reaction of benzene with gaseous chlorine in the presence of a catalyst. Aniline is produced from nitrobenzene which is itself produced by reaction of benzene with forms of nitric acid. In both cases, benzene is derived from fossil fuel sources. Acetone is produced in multiple ways including oxidation of cumene; dehydrogenation or oxidation of isopropyl alcohol with metallic catalyst; vapor-phase oxidation of butane; by-product of synthetic glycerol production.</p> <p>The base ingredients are therefore benzene, cumene, nitric acid, an unstated catalyst, chlorine, and isopropyl alcohol.</p>	Yes. Cumene, benzene, and subsequent chemicals in the production chain are all likely derived from fossil fuel sources.	acetone aniline benzene butane chlorine chlorobenzenes chloronitrobenzenes cumene glycerol isopropyl alcohol nickel/chromium catalyst nitric acid nitrobenzene P-nitrodiphenylamine
CPPD (N-cyclohexyl-N'-phenyl-p-phenylenediamine)	101-87-1	No PubChem data on manufacturing. However, as a PPD-family molecule it is likely that chemicals such as aniline, nitrobenzene and benzene are all parts of the production cycle. Thus, it appears likely to have similar production processes as the other PPDs.	Yes, expected to be similar to 6PPD.	Expected to be similar to 6PPD

Chemical	CAS No.	Production Process	Precursor Fossil Fuel Based?	Possible Chemicals Involved Across Lifecycle
DPPD (N,N'-diphenyl-p-phenylenediamine)	74-31-7	Prepared by condensing hydroquinone or p-aminophenol with aniline. Hydroquinone is produced <i>via</i> multiple pathways: <i>via</i> hydroxylation of phenol with hydrogen peroxide, <i>via</i> oxidation of aniline with manganese dioxide, or from derivatization of benzene and cumene. Phenol is typically produced via oxidation of benzene or toluene. Aniline is produced from nitrobenzene which is itself produced by reaction of benzene with forms of nitric acid.	Yes. Cumene, benzene, and toluene are all likely derived from fossil fuel sources.	aniline p-aminophenol benzene cumene hydroquinone hydrogen peroxide manganese dioxide nitric acid nitrobenzene phenol toluene
6QDI (N-1,3-dimethyl butyl-N'-phenyl quinone diamine)	52870-46-9	6QDI is the oxidized form of 6PPD (where the nitrogen atoms around the central phenyl ring have double bonds instead of single bond plus a hydrogen atom). It therefore would have the same production process as 6PPD.	Yes, expected to be the same as 6PPD.	Expected to be the same as 6PPD.
TMQ (polymerized 2,2,4-trimethyl-1,2-dihydroquinoline)	147-47-7	Reaction of quinoline and acetone. Quinoline is produced <i>via</i> reaction of aniline with glycerol and nitrobenzene in presence of sulfuric acid. Acetone is produced in multiple ways including oxidation of cumene; dehydrogenation or oxidation of isopropyl alcohol with metallic catalyst; vapor-phase oxidation of butane; and by-product of synthetic glycerol production. Aniline is produced from nitrobenzene which is itself produced by reaction of benzene with forms of nitric acid. Nitrosophenol is produced by the reaction of nitrous acid on phenol; phenol itself is produced by oxidation of cumene. Glycerol is derived from plant matter while nitrobenzene (as noted above) is derived from benzene and nitric acid. The base ingredients are therefore hydrocarbons such as cumene, benzene, and butane as well as various catalysts and reagents (<i>e.g.</i> , acids).	Yes. Cumene, benzene and butane are all likely derived from fossil fuel sources.	acetone aniline benzene butane cumene glycerol isopropyl alcohol nitric acid nitrobenzene nitrosophenol nitrous acid phenol quinoline sulfuric acid various catalysts
77PD (N,N'-Bis(1,4-dimethylpentyl)-p-phenylenediamine)	3081-14-9	No PubChem data on manufacturing. However, as a PPD-family molecule it is likely that chemicals such as aniline, nitrobenzene, and benzene are all parts of the production cycle. Thus, it appears likely to have similar production processes as the other PPDs.	Yes, expected to be similar to 6PPD.	Expected to be similar to 6PPD
4,4'-Dioclyldiphenylamine (DOPD)	101-67-7	Self-condensation of p-octylaniline in the presence of mineral acids such as hydrochloric acid. By analogy with ethylaniline, octyl aniline is likely produced by heating aniline and octanol with sulfuric acid, with subsequent distillation. Aniline is produced from nitrobenzene which is itself produced by reaction of benzene with forms of nitric acid. Hydrochloric acid is produced by reaction of sodium chloride and sulfuric acid or sulfur dioxide or as a by-product of the synthesis of chlorinated hydrocarbons.	Yes. Benzene and other chemicals produced from fossil fuel materials.	aniline benzene chlorinated hydrocarbons hydrochloric acid nitric acid nitrobenzene octanol p-octylaniline sulfuric acid sulfur dioxide

Chemical	CAS No.	Production Process	Precursor Fossil Fuel Based?	Possible Chemicals Involved Across Lifecycle
CCPD (N,N'-dicyclohexyl-p-phenylenediamine)	4175-38-6	No PubChem data on manufacturing. However, as a PPD-family molecule it is likely that chemicals such as aniline, nitrobenzene, and benzene are all parts of the production cycle. Thus, it appears likely to have similar production processes as the other PPDs.	Yes, expected to be similar to 6PPD.	Expected to be similar to 6PPD
DAPD (diaryl-p-phenylene diamine)	68953-84-4	No PubChem data on manufacturing. However, as a PPD-family molecule it is likely that chemicals such as aniline, nitrobenzene, and benzene are all parts of the production cycle. Thus, it appears likely to have similar production processes as the other PPDs.	Yes, expected to be similar to 6PPD.	Expected to be similar to 6PPD
DNPDA (N,N'-Di-2-naphthyl-p-phenylenediamine)	93-46-9	No PubChem data on manufacturing. However, as a PPD-family molecule it is likely that chemicals such as aniline, nitrobenzene, and benzene are all parts of the production cycle. Thus, it appears likely to have similar production processes as the other PPDs.	Yes, expected to be similar to 6PPD.	Expected to be similar to 6PPD
NBC (Nickel dibutylthiocarbamate)	13927-77-0	Reaction of aqueous solutions of sodium dibutylthiocarbamate and nickel chloride, acetate, or sulfate. Sodium dibutylthiocarbamate is produced by reaction of carbon disulfide with dibutylamine in the presence of aqueous sodium hydroxide. Carbon disulfide is produced by combining sulfur with charcoal or methane. Dibutylamine is produced <i>via</i> reaction of ammonia with butyl bromide or chloride which, in turn, are produced by reacting the halogen gas with natural gas fractions. Sodium hydroxide is produced commercially <i>via</i> electrolysis of sodium chloride. Nickel chloride/acetate/sulfate are produced by reacting nickel ores (<i>e.g.</i> , nickel oxide) with the requisite acid.	Yes. There are hydrocarbons and other chemicals produced from fossil fuel materials.	acids ammonia butyl bromide or chloride carbon disulfide charcoal dibutylamine methane nickel chloride, acetate, or sulfate nickel ores (<i>e.g.</i> , nickel oxide) sodium chloride sodium dibutylthiocarbamate sodium hydroxide sulfur
Ethoxyquin	91-53-2	Reaction of acetone with p-phenetidine and iodine at 120-130 C. Distillation to isolate ethoxyquin. Acetone is produced in multiple ways including oxidation of cumene; dehydrogenation or oxidation of isopropyl alcohol with metallic catalyst; vapor-phase oxidation of butane; by-product of synthetic glycerol production. p-Phenetidine (ethoxylaniline). No data in PubChem but presumably involves oxidation of aniline. Iodine is obtained from natural sources (brine) often with the use of sulfuric acid and chlorine.	Yes. There are hydrocarbons and other chemicals produced from fossil fuel materials.	acetone aniline butane chlorine cumene ethoxyquin glycerol iodine isopropyl alcohol metallic catalyst p-phenetidine (ethoxylaniline) sulfuric acid

Chemical	CAS No.	Production Process	Precursor Fossil Fuel Based?	Possible Chemicals Involved Across Lifecycle
Dilauryl thiodipropionate	123-28-4	<p>Reaction of thiodipropionitrile (TDPN) with lauryl alcohol using acid catalysts (hydrochloric acid and sulfuric acid).</p> <p>Lauryl alcohol produced by addition of ethylene to triethylaluminum or hydrogenation of methyl laurate. Also produced <i>via</i> reduction of esters of lauric acid with sodium and absolute alcohol or by reduction of coconut-oil fatty acids. Ethylene is obtained from fossil fuel sources.</p> <p>Hydrochloric acid is produced by reaction of sodium chloride and sulfuric acid or sulfur dioxide or as a by-product of the synthesis of chlorinated hydrocarbons.</p> <p>Sulfuric acid is produced by reacting sulfur dioxide with oxygen or nitric oxide</p>	Yes. There are hydrocarbons and other chemicals produced from fossil fuel materials.	chlorinated hydrocarbons coconut fatty acids ethanol ethylene hydrochloric acid lauric acid lauryl alcohol methyl laurate nitric oxide oxygen sodium chloride sulfur dioxide sulfuric acid thiodipropionitrile (TDPN) triethylaluminum
DTPD (N,N'-Ditolyl-p-phenylenediamine)	68953-84-4	No PubChem data on manufacturing. However, as a PPD-family molecule it is likely that chemicals such as aniline, nitrobenzene, and benzene are all parts of the production cycle. Thus, it appears likely to have similar production processes as the other PPDs.	Yes, expected to be similar to 6PPD.	Expected to be similar to 6PPD
1,4-Benzenediamine, N,N'-bis(2-methylphenyl)	15017-02-4	No PubChem data on manufacturing. However, as a PPD-family molecule it is likely that chemicals such as aniline, nitrobenzene, and benzene are all parts of the production cycle. Thus, it appears likely to have similar production processes as the other PPDs.	Yes, expected to be similar to 6PPD.	Expected to be similar to 6PPD
N'-Phenyl-N-Fluorenyl-Para-Phenylenediamine	None Provided	No PubChem data on manufacturing. However, as a PPD-family molecule it is likely that chemicals such as aniline, nitrobenzene, and benzene are all parts of the production cycle. Thus, it appears likely to have similar production processes as the other PPDs.	Yes, expected to be similar to 6PPD.	Expected to be similar to 6PPD
N-(p-phenylthiomethylphenyl)-N'-(1,3 dimethyl-butyl)-p-phenylenediamine	None Provided	No PubChem data on manufacturing. However, it contains the 6PPD structure bonded to thioanisole between the terminal benzene moiety of 6PPD and the terminal methyl moiety of thioanisole. It is likely that chemicals such as aniline, nitrobenzene, and benzene are all parts of the production cycle from the production of 6PPD. Additionally, phenyl mercaptan and an alkylating agent are used to manufacture thioanisole (US Patent 4124646A) so it is likely they are also part of the production process. Thus, aside from reacting phenyl mercaptan with an alkylating agent, it appears likely to have similar production processes as the other PPDs.	Yes, expected to be similar to 6PPD.	Expected to be similar to 6PPD Phenyl Mercaptan
4-(2,5-dimethyl-1H-pyrrol-1-yl)-N-phenylaniline	None Provided	No PubChem data on manufacturing. However, as a PPD-family molecule it is likely that chemicals such as aniline, nitrobenzene, and benzene are all parts of the production cycle. Thus, it appears likely to have similar production processes as the other PPDs.	Yes, expected to be similar to 6PPD.	Expected to be similar to 6PPD

Chemical	CAS No.	Production Process	Precursor Fossil Fuel Based?	Possible Chemicals Involved Across Lifecycle
N,N - (ethane-1,2-diyl) bis (N-phenylbenzene-1,4-diamine; or similar chemical 1-N-[2-(4-anilinoanilino)ethyl]-4-N-phenylbenzene-1,4-diamine	None Provided	No PubChem data on manufacturing. However, as a PPD-family molecule it is likely that chemicals such as aniline, nitrobenzene, and benzene are all parts of the production cycle. Thus, it appears likely to have similar production processes as the other PPDs.	Yes, expected to be similar to 6PPD.	Expected to be similar to 6PPD
4-N-(2,3-dimethylphenyl)-1-N-phenylbenzene-1,4-diamine- R1 and R2 are methyl	None Provided	No PubChem data on manufacturing. However, as a PPD-family molecule it is likely that chemicals such as aniline, nitrobenzene, and benzene are all parts of the production cycle. Thus, it appears likely to have similar production processes as the other PPDs.	Yes, expected to be similar to 6PPD.	Expected to be similar to 6PPD
RU997 Irgazone 997	444992-04-5	No PubChem data on manufacturing. However, CAS 444992-04-05 is a reaction product of N-phenyl-N'-(1,3dimethylbutyl)-p-phenylenediamine with an alkyl glycidylthioether. N-phenyl-N'-(1,3 dimethylbutyl)-p-penylenediamine is a PPD family molecule, so it is likely that chemicals such as aniline, nitrobenzene, and benzene are all parts of the production cycle. Thus, it appears likely to have a similar production process as 6PPD.	Yes, expected to be similar to 6PPD.	Expected to be similar to 6PPD glycidylthioether
4-[4-(4-Methylpentan-2-ylamino)anilino]phenol	None Provided	No PubChem data on manufacturing. However, as a PPD-family molecule it is likely that chemicals such as aniline, nitrobenzene, and benzene are all parts of the production cycle. Thus, it appears likely to have similar production processes as the other PPDs.	Yes, expected to be similar to 6PPD.	Expected to be similar to 6PPD
This is a class of compounds. Reference uses case where R1 and R2 are methyl; n,p and q are zero and m=1 and is in the para position. Reference compound is CAS 6358-22-1	6358-22-1	This class of compounds is produced by reaction of N,N-Dimethyl-p-phenylenediamine and phenol. N,N-Dimethyl-p-phenylenediamine is produced <i>via</i> the reduction of p-nitrosodimethylaniline with zinc dust and hydrochloric acid, and the oxidation of cumene. P-nitrosodimethylaniline is produced <i>via</i> reduction of nitrous acid with dimethylaniline. Dimethylaniline is produced from aniline and methanol under pressure in the presence of acidic catalysts. Therefore, the key ingredients are aniline, methanol, and cumene.	Yes, cumene, aniline, and methanol are likely derived from fossil fuel remnants.	Aniline Cumene Dimethylaniline Methanol Nitrous Acid
N,N-diethyl-2,2,4-trimethyl-1H-quinolin-6-amine (R=N(C2H5)2	None Provided	No PubChem data on manufacturing. However, as the same class of chemical as N,N-Dimethyl-p-phenylenediamine it is likely that chemicals such as dimethylaniline, nitrous acid, aniline, methanol, and cumene are all parts of the production cycle. Thus, it appears likely to have similar production processes as other compounds in the same family as N,N-Dimethyl-p-phenylenediamine.	Yes, cumene, aniline, and methanol are likely derived from fossil fuel remnants.	Expected to be similar to Phenol, 4-[[4-(dimethylamino)phenyl]a
Mixed xylene diamines N,N'-Dibenzyl-p-xylene-alpha,alpha'-diamine-	25790-41-4	No PubChem data on manufacturing. However, as the same class of chemical as benzylamine it is likely that chemicals such as chlorine, toluene, and ammonia are all parts of the production cycle. Thus, it appears likely to have similar production processes as other compounds in the Benzylamine family. Benzylamine is produced by the reaction of benzyl chloride with ammonia in aqueous solution. Benzyl chloride is produced by passing chlorine over boiling toluene, and then washing with water.	Yes. Toluene is produced during petroleum refining operations.	Ammonia Benzylamine Benzyl chloride Chlorine Toluene

Chemical	CAS No.	Production Process	Precursor Fossil Fuel Based?	Possible Chemicals Involved Across Lifecycle
2,4,6-tris-(N-1,4-dimethylpentyl-para-phenylenediamino)-1,3,5-triazine, TAPDT	121246-28-4	No PubChem data on manufacturing. However, as a PPD-family molecule it is likely that chemicals such as aniline, nitrobenzene, and benzene are all parts of the production cycle. Thus, it appears likely to have similar production processes as the other PPDs.	Yes, expected to be similar to 6PPD.	Expected to be similar to 6PPD
N-Phenyl-1-naphthylamine	90-30-2	Reaction of alpha-naphthylamine (CAS 134-32-7) with aniline, and purified <i>via</i> distillation. Aniline is produced from nitrobenzene which is itself produced by reaction of benzene with forms of nitric acid. Alpha-naphthylamine is produced from either reduction by catalytic hydrogenation with a nickel catalyst or being reduced with iron in hydrochloric acid. 1-nitronaphthalene in turn is prepared by the action of acids (nitric and sulfuric) on ground naphthalene. The key ingredients are therefore benzene, nitric acid, naphthalene, nitric acid, and hydrochloric acid.	Yes. Naphthalene is derived from coal tar.	Aniline Benzene Hydrochloric Acid Metallic Catalyst Naphthalene α -Naphthylamine Nitric Acid Nitrobenzene 1-Nitronaphthalene Sulfuric Acid
N-Phenyl-2-naphthylamine	135-88-6	Produced either by heating 2-naphthol with aniline hydrochloride, or condensation of 2-naphthol and aniline in the presence of a catalyst. 2-Naphthol is produced by caustic fusion of naphthalene-2-sulfonic acid. No PubChem data is available on the production of naphthalene-2-sulfonic acid; however, it is likely this process involves naphthalene and sulfonic acid. Aniline is produced from nitrobenzene which is itself produced by reaction of benzene with forms of nitric acid. Aniline hydrochloride is produced from a reaction of aniline and hydrochloride. The key ingredients are therefore benzene, aniline, hydrochloride, naphthalene, sulfonic acid, and nitric acid.	Yes. Naphthalene is derived from coal tar.	Aniline Aniline Hydrochloride Benzene Benzenamine Hydrochloride Naphthalene 2-Naphthol Nitric Acid Nitrobenzene Sulfonic Acid
Irganox 1520	110553-27-0	The only available PubChem manufacturing data is a TSCA Commercial Activity Status for Phenol. CAS 110553-27-0 can thus be defined as a phenol family compound. It is likely that chemicals such as cumene and oxygen are parts of the production cycle. Thus, it is likely that production involves oxidation of cumene with oxygen to cumene hydroperoxide, and cleavage of cumene hydroperoxide in an acidic medium to phenol and acetone. The compound, additionally, has two long alkyl sulfur chains. However, there is no manufacturing information available for these structures on PubChem.	Yes. Cumene is likely derived from fossil fuel sources.	Cumene Oxygen
Graphene	1034343-98-0	Produced from organic materials that are rich in carbon, such as coal, lignite, wood, nut shells, peat, pitches, and cokes. Manufacturing is done through either thermal activation or chemical activation.	Some carbon sources are fossil fuel based.	Carbon

Chemical	CAS No.	Production Process	Precursor Fossil Fuel Based?	Possible Chemicals Involved Across Lifecycle
1,1' - Pentamethylenebis(2,2-Di-n- Butylhydrazine)	None Provided	No PubChem data on manufacturing. However, 1,1' - pentamethylenebis(2,2-Di-n-Butylhydrazine) is a hydrazine, so it is likely that chemicals such as chlorine, sodium hydroxide, and ammonia are parts of the production cycle. The production of hydrazine involves the reaction of sodium hypochlorite and ammonia to yield chloramine and sodium hydroxide, followed by the reaction of chloramine, ammonia, and sodium hydroxide to yield hydrazine, sodium, chloride, and water. Sodium hypochlorite is produced when chlorine is added to a cold dilute solution of sodium hydroxide.	Hydrazine is not fossil fuel based, but compound has large alkyl groups that are likely fossil fuel based.	Ammonia Chloramine Chlorine Hydrazine Sodium Hydroxide Sodium Hypochlorite
α - C-4- hydroxy- 3,5-dimethylphenyl (Lowinox WSP - 77-62-3) . No number for nitrone - N-isopropyl nitrone and Lowinox WSP	77-62-3 No CAS for N-isopropyl nitrone	No PubChem data on manufacturing. However, CAS 77-62-3 is a phenol family compound, so it is likely that chemicals such as cumene and oxygen are parts of the production cycle. Thus, it is likely that production involves oxidation of cumene with oxygen to cumene hydroperoxide, and cleavage of cumene hydroperoxide in an acidic medium to phenol and acetone. No PubChem manufacturing information is available for N-isopropyl nitrone. However, N-isopropyl nitrone is likely a formaldehyde family compound because Nitrone (75-17-2) is defined as a formaldehyde family compound by the TSCA. It is then likely that chemicals such as methanol are a part of the production process.	Yes. Cumene is likely derived from fossil fuel sources.	Cumene Formaldehyde Methanol Oxygen
N-(4-methylpentan-2-yl)-10H-phenothiazin-3-amine	None Provided	No PubChem data on manufacturing. However, as a PPD-family molecule it is likely that chemicals such as aniline, nitrobenzene, and benzene are all parts of the production cycle. Thus, it appears likely to have similar production processes as the other PPDs.	Yes, expected to be similar to 6PPD.	Expected to be similar to 6PPD
7-(4-methylpentan-2-ylamino)-2,3,4,10-tetrahydro-1H-acridin-9-one	None Provided	No PubChem data on manufacturing. However, as a PPD-family molecule it is likely that chemicals such as aniline, nitrobenzene, and benzene are all parts of the production cycle. Thus, it appears likely to have similar production processes as the other PPDs.	Yes, expected to be similar to 6PPD.	Expected to be similar to 6PPD
2-cyclohexyl-N-(4-methylpentan-2-yl)-1H-indol-5-amine	None Provided	No PubChem data on manufacturing. However, as a PPD-family molecule it is likely that chemicals such as aniline, nitrobenzene, and benzene are all parts of the production cycle. Thus, it appears likely to have similar production processes as the other PPDs.	Yes, expected to be similar to 6PPD.	Expected to be similar to 6PPD
4-(1H-indol-2-yl)-N-(4-methylpentan-2-yl)aniline	None Provided	No PubChem data on manufacturing. However as an aniline-family molecule it is likely that chemicals such as nitrobenzene and benzene are both parts of the production cycle. It is likely that the nitration of benzene with mixed acid, and the hydrogenation of nitrobenzene are both parts of the production process. As this chemical has the same MIBK derivative tail structure as 6PPD it is likely that acetone is also a key component of the manufacturing process.	Yes, expected to be similar to 6PPD.	Expected to be similar to 6PPD

Chemical	CAS No.	Production Process	Precursor Fossil Fuel Based?	Possible Chemicals Involved Across Lifecycle
α - C-4- Hydroxy- 3,5-dimethylphenyl- N-tert. butyl nitron	None Provided	No PubChem manufacturing information is available for α - C-4- hydroxy- 3,5- dimethyl phenyl- N- tert. butyl nitron. However, this chemical is likely a formaldehyde family compound because nitron (CAS 75-17-2) is defined as a formaldehyde family compound by the TSCA. According to the patent related to identification of this possible alternative (see Appendix D), the chemical was produced by reaction of N-tert-butyl-hydroxylamine and 3,5-dimethyl-4-hydroxybenzaldehyde in ethanol. No information could be located in PubChem for these two reagents but benzaldehydes in general are reported to be ultimately derived from toluene.	Yes. Toluene is likely derived from fossil fuel sources.	t-Butyl hydroxylamine Dimethyl benzaldehyde Ethanol Toluene
Amine functionalized lignin	None Provided	Lignin is a waste product of wood processing. Lignin must be isolated from the wood pulp and this appears to be done using various solvents such as sodium sulfide, dioxane, or methanol, along with acid catalysts or formaldehyde (Bertella and Luterbacher, 2020). The specific isolation process yields different results and would need to be optimized for an antiozonant. Formaldehyde and urea or azides have been suggested as possible reagents for amination of lignin (Bertella and Luterbacher, 2020) although the specific of amine functionalization to produce anti-ozone activity are not known. It should also be noted that as lignin is a biological material, consistency in material over time is a concern.	Not if lignin is obtained from wood product production waste.	Azides Dioxane Formaldehyde Methanol Sodium sulfide Urea
Rambutan peel extract	None Provided	Rambutan peel extract is extracted from the peel of the tropic fruit, rambutan. Peels are washed, dried, and then extracted with various solvents such as water/ethanol or methanol. Hydrochloric acid and sodium hydroxide are also reported to be used during extraction (Zhang <i>et al.</i> , 2022). Purification of the crude extract has been conducted with purification resins, High-performance liquid chromatography (HPLC), <i>etc.</i> It seems likely that other methods would be required to produce extract at scale. Only one study is available on rambutan peel extract's potential antioxidant/antiozonant properties in tires (Sukatta <i>et al.</i> , 2021), in which the active ingredients responsible for potential antioxidant or antiozonant properties are not confidently identified. It is unclear if the existing volume of discarded rambutan peel would be able to produce enough extract to replace 6PPD in tires. It also seems likely that synthesis of the active ingredients (once these are known) to replace 6PPD in tires would likely involve use of fossil fuel based chemistry.	Not if produced solely from agricultural waste; yes if active ingredients are synthesized.	Ethanol Hydrochloric acid Methanol Possible fossil fuel based precursors Sodium hydroxide
N-1-Methylheptyl-N'-phenyl-p-phenylenediamine (8PPD)	15233-47-3	No PubChem data on manufacturing. However, as a PPD-family molecule it is likely that chemicals such as aniline, nitrobenzene, and benzene are all parts of the production cycle. Thus, it appears likely to have similar production processes as the other PPDs.	Yes, expected to be similar to 6PPD.	Expected to be similar to 6PPD

Chemical	CAS No.	Production Process	Precursor Fossil Fuel Based?	Possible Chemicals Involved Across Lifecycle
Octyl gallate	1034-01-1	By analogy with propyl gallate, possible production pathways for octyl gallate likely include esterification of gallic acid with octyl alcohol followed by separation <i>via</i> distillation. Octyl alcohol can be produced from natural sources (coconut oil and other oils or fatty acids) or from fossil fuel derived ethylene or 1,3-butadiene <i>via</i> polymerization and subsequent oxidation. Gallic acid (trihydroxy benzoic acid) is produced from chemical or enzymatic hydrolysis of tannins, a by-product of paper and pulp production. The structurally-related hydroxybenzoic acid is produced by oxidation of p-cresol, by carboxylation of potassium phenolate, and by interaction of 1-aminobenzoic acid and nitrous acid; all processes that are fossil fuel based. Whether similar processes could be commercially employed to produce gallic acid/trihydroxy benzoic acid is unclear.	Possibly if naturally derived sources are insufficient to meet demand.	Coconut oil Plant based oils Ethylene Butadiene Tannins p-Cresol (possibly) Potassium phenolate (possibly) Aminobenzoic acid (possibly)
Nano calcium carbonate surface modified by gallic acid	None Provided	Gallic acid modified calcium carbonate nanomaterials are produced by reaction of calcium carbonate nanoparticles with gallic acid. Calcium carbonate nanoparticles can be produced by mechanical processing of bulk calcium carbonate (<i>e.g.</i> , crushing, milling, or grinding) or by controlled reactions of solutions of bicarbonate ion and calcium (<i>e.g.</i> , sodium bicarbonate and sodium chloride) (Fadia <i>et al.</i> , 2021). The starting materials for these processes are all obtained by mining. Gallic acid (trihydroxy benzoic acid) is produced from chemical or enzymatic hydrolysis of tannins, a by-product of paper and pulp production. The structurally-related hydroxybenzoic acid is produced by oxidation of p-cresol, by carboxylation of potassium phenolate, and by interaction of 1-aminobenzoic acid and nitrous acid; all processes which are fossil fuel-based. Whether similar processes could be commercially employed to produce gallic acid/trihydroxy benzoic acid is unclear.	Possibly if naturally derived sources are insufficient to meet demand for gallic acid.	Calcium carbonate Sodium bicarbonate Sodium chloride Tannins p-Cresol (possibly) Potassium phenolate (possibly) Aminobenzoic acid (possibly)
Specialized carbon nanotube mixture	None Provided	Carbon nanotubes are produced by various methods, the most common being chemical vapor deposition (CVD) (Mubarak <i>et al.</i> , 2014). All production requires a source of carbon, in the case of CVD, gases such as methane, carbon monoxide or ethylene are used (Mubarak <i>et al.</i> , 2014; Zhuo <i>et al.</i> , 2018). These are typically obtained from fossil fuels although non-fossil fuel sources (<i>e.g.</i> , biogas) have been discussed. Whether these non-fossil fuel sources can meet production needs is unclear. The production process also involves metal catalysts.	Possibly if naturally derived carbon sources are insufficient to meet needs or are less economical.	Ethylene Methane Carbon monoxide Various metal catalysts

Notes:

CAS No. = Chemical Abstracts Service Number; HPLC = High-Performance Liquid Chromatography; MIBK = Methyl isobutyl Ketone; PPD = Paraphenylene Diamines; TSCA = Toxic Substances Control Act.

Table 5.1 Chemical-Specific Human Health Hazards (Group A Endpoints)

Class of Compound	Chemical	CAS	Score ¹	Reference	Group A Endpoints											California Proposition 65	
					Acute Mammalian Toxicity	Carcinogenicity	Eye Irritation/Corrosion	Skin Irritation/Corrosion (Dermatotoxicity)	Germ Cell Mutagenicity	Target Organ Toxicity – Single Exposure	Target Organ Toxicity – Repeated Exposure	Reproductive/Developmental Toxicity	Sensitizer – Respiration ²	Sensitizer – Skin	Endocrine Disruptor		
Current Priority Product Chemical of Concern																	
Phenylene Diamine related	N-(1,4-dimethylbutyl)-N'-phenyl-p-phenylenediamine (6PPD)	793-24-8		ECHA, 2024; ToxServices, 2021a; Cal OEHA, 2024; Danish EPA, 2023; Commission of the European Communities, 2001	Oral: Cat. 4; Dermal: Not Classified; Inhalation: DG (ECHA, 2024; ToxServices, 2021a)	Not Classified	Not Classified (ECHA, 2024); Cat. 3 (ToxServices, 2021a)	Not Classified	Not Classified	Not Classified (ECHA, 2024); DG (ToxServices, 2021a)	Not Classified (ECHA, 2024); Cat. 2 (ToxServices, 2021a)	Cat. 1B (ECHA, 2024)	DG (ECHA, 2024); Cat. 1B based on skin sensitization and respiratory structural alert (ToxServices, 2021a)	Cat. 1 (ECHA, 2024); Cat. 1A (ToxServices, 2021a)	Not Listed (EU); Moderate based on altered female pubertal development in rats (ToxServices, 2021a)	Not Listed	
			125	5	0	5	0	0	0	0	10	50	5	25	25	0	
Potential Alternatives																	
Phenylene Diamine	N-(1,4-dimethylpentyl)-N'-phenyl-p-phenylenediamine (7PPD)	3081-01-4		ECHA, 2024; ToxServices, 2021b; Cal OEHA, 2024; Danish EPA, 2023; Commission of the European Communities, 2001	Oral: Not Classified; Dermal: Not Classified; Inhalation: DG (ECHA, 2024; ToxServices, 2021b)	Not Classified	Not Classified (ECHA, 2024); Cat. 3 (ToxServices, 2021b)	Not Classified	Not Classified	Not Classified	Not Classified (ECHA, 2024); Cat. 2 (ToxServices, 2021b)	Cat. 1B (ECHA, 2024; ToxServices, 2021b)	DG (ECHA, 2024); Cat. 1B based on skin sensitization and respiratory structural alert (ToxServices, 2021b)	Cat. 1 (ECHA, 2024); Cat. 1A (ToxServices, 2021b)	Not Listed (EU); Moderate based on altered female pubertal development in rats for surrogate 6PPD CAS 793-24-8 (ToxServices, 2021b)	Not Listed	
			120	0	0	5	0	0	0	0	10	50	5	25	25	0	
Phenylene Diamine	N-isopropyl-N'-phenyl-p-phenylenediamine (IPPD)	101-72-4		ECHA, 2024; ToxServices, 2021c; Cal OEHA, 2024; Danish EPA, 2023; Commission of the European Communities, 2001	Oral: Cat. 4; Dermal: Not Classified; Inhalation: DG (ECHA, 2024; ToxServices, 2021c)	DG (ECHA, 2024); Not classified based on surrogate 6PPD (ToxServices, 2021c)	Not Classified (ECHA, 2024); Cat. 2B (ToxServices, 2021c)	Not Classified	Not Classified	Not Classified (ECHA, 2024); DG (ToxServices, 2021c)	Not Classified (ECHA, 2024); Cat. 2 (ToxServices, 2021c)	Not Classified (ECHA, 2024); Cat. 1B based on 6PPD (ToxServices, 2021c)	DG (ECHA, 2024); Cat. 1B based on skin sensitization and respiratory structural alert (ToxServices, 2021c)	Cat. 1 (ECHA, 2024); Cat. 1A (ToxServices, 2021c)	Not Listed (EU); Moderate based on altered female pubertal development in rats for surrogate 6PPD CAS 793-24-8. In silico modeling reported IPPD to be a potential endocrine receptor modulator (ToxServices, 2021c)	Not Listed	
			150	5	25	5	0	0	0	0	10	50	5	25	25	0	
Phenylene Diamine	N-cyclohexyl-N'-phenyl-p-phenylenediamine (CPPD)	101-87-1		CalOEHA, 2024; Danish EPA, 2023; Commission of the European Communities, 2001	DG	DG	DG	DG	DG	DG	DG	DG	DG	DG	DG	Not Listed (EU) though very little data are available for this chemical	Not Listed
			Not assigned based on complete data gap														
Phenylene Diamine	N,N'-diphenyl-p-phenylenediamine (DPPD)	74-31-7		ECHA, 2024; Cal OEHA, 2024; Danish EPA, 2023; Commission of the European Communities, 2001	Oral: Not Classified; Dermal: Not Classified; Inhalation: Not Classified	Not Classified	Not Classified	Not Classified	Cat. 2	Not Classified	Not Classified	Cat. 2	DG	Cat. 1	Not Listed (EU)	Not Listed	
			80	0	0	0	0	25	0	0	25	5	25	0	0		
Phenylene Diamine related	N-1,3-dimethyl butyl-N'-phenyl quinone diimine (6QDI)	52870-46-9		ECHA, 2024; ToxServices, 2021d; Cal OEHA, 2024; Danish EPA, 2023; Commission of the European Communities, 2001	Oral: Not Classified; Dermal: Not Classified; Inhalation: DG	DG (ECHA, 2024); Not classified based on surrogate 6PPD (ToxServices, 2021d)	Cat. 2	Not Classified	DG (ECHA, 2024); Not classified based on surrogate 6PPD (ToxServices, 2021d)	DG (ECHA, 2024); Cat. 3 (ToxServices, 2021d)	DG (ECHA, 2024); Cat. 2 based on surrogate 6PPD (ToxServices, 2021d)	DG (ECHA, 2024); Cat. 1B based on 6PPD (ToxServices, 2021d)	DG	Not classified (ECHA, 2024); Cat. 1A based on surrogate 6PPD (ToxServices, 2021d)	Not Listed (EU); Moderate based on altered female pubertal development in rats for surrogate 6PPD (ToxServices, 2021d)	Not Listed	
			175	0	25	5	0	25	5	10	50	5	25	25	0		
Dihydroquinoline	Polymerized 2,2,4-trimethyl-1,2-dihydroquinoline (TMQ Oligomer)	26780-96-1		ECHA, 2024; ToxServices, 2021e; Cal OEHA, 2024; Danish EPA, 2023; Commission of the European Communities, 2001	Oral: Cat. 4 (based on surrogate ethoxyquin CAS 91-53-2) (ToxServices, 2021e); Not classified (ECHA, 2024); Dermal: Not classified (based on surrogate ethoxyquin CAS 91-53-2); Not classified (ECHA, 2024); Inhalation: Not classified (based on surrogate ethoxyquin CAS 91-53-2); DG (ECHA, 2024)	Cat. 2 (ToxServices, 2021e); Not classified (ECHA, 2024)	Not classified	Not classified	Not classified	Not classified (ECHA, 2024); Cat. 1 based on surrogate ethoxyquin CAS 91-53-2, even though the more similar surrogate TMDHQ oligomers (26780-96-1) was not a hazard for both oral and dermal (ToxServices, 2021e)	Not classified (ECHA, 2024); Cat. 1 (ToxServices, 2021e)	Not classified (ECHA, 2024); Cat. 2 based on a surrogate TMDHQ oligomers (26780-96-1) and surrogate ethoxyquin CAS 91-53-2 (ToxServices, 2021e)	DG (ECHA, 2024); Not classified (ToxServices, 2021e)	Not classified based on surrogate TMDHQ oligomers (26780-96-1) (ToxServices, 2021e); Not classified (ECHA, 2024)	Not Listed (EU); DG (ToxServices, 2021d)	Not Listed	
			170	5	75	0	0	0	0	25	25	25	5	0	10	0	
Phenylene Diamine	N,N'-Bis(1,4-dimethylpentyl)-p-phenylenediamine (77PD)	3081-14-9		ECHA, 2024; ToxServices, 2021f; Cal OEHA, 2024; Danish EPA, 2023; Commission of the European Communities, 2001	Oral: Cat. 4; Dermal: Not Classified; Inhalation: DG	Not Classified	Not Classified	Not Classified	Not Classified	Not Classified	Not Classified (ECHA, 2024); Cat. 2 (ToxServices, 2021f)	Not Classified (ECHA, 2024); Cat. 2 for Developmental toxicity (ToxServices, 2021f)	DG (ECHA, 2024); Cat. 1B based on skin sensitization and respiratory structural alert (ToxServices, 2021f)	Cat. 1	Not Listed (EU); DG (ToxServices, 2021f)	Not Listed	
			80	5	0	0	0	0	0	0	10	25	5	25	10	0	
Diphenyl amine	4,4'-Dioclyldiphenylamine (DOPD)	101-67-7		Cal OEHA, 2024; Danish EPA, 2023; Commission of the European Communities, 2001	DG	DG	DG	DG	DG	DG	DG	DG	DG	DG	Not Listed (EU) though no data are available for this chemical	Not Listed	
			Not assigned based on complete data gap														
Phenylene diamine	N,N'-Ditolyl-p-phenylenediamine (Commercial DTPD)	68953-84-4		Cal OEHA, 2024; Danish EPA, 2023; Commission of the European Communities, 2001	Oral: Not Classified; Dermal: Not Classified; Inhalation: Not Classified	Not Classified	Not Classified	Not Classified	Not Classified	Not Classified	Not Classified	Cat. 2	DG	Cat. 1B	Not Listed (EU)	Not Listed	
			55	0	0	0	0	0	0	0	25	5	25	0	0		
Phenylene Diamine	N,N'-Dicyclohexyl-p-phenylenediamine (CCPD)	4175-38-6		ToxServices, 2021g; Cal OEHA, 2024; Danish EPA, 2023; Commission of the European Communities, 2001	Oral: Cat. 3 (based on surrogate 44PD); Dermal: Cat. 3 (based on surrogate 44PD); Inhalation: DG	Not classified based on surrogate 44PD	Cat. 2A based on surrogate 44PD	Cat. 1 based on surrogate 44PD	Not classified	DG	Cat. 1 based on surrogate 44PD	Cat. 2 based on surrogate 44PD	Cat. 1B based on surrogate 44PD's dermal sensitization data and respiratory sensitization structural alert (ToxServices, 2021g)	Cat. 1A based on surrogate 44PD	Not Listed (EU); DG (ToxServices, 2021g)	Not Listed	
			115	10	0	5	5	0	5	25	25	5	25	10	0		

Class of Compound	Chemical	CAS	Score ¹	Reference	Group A Endpoints										California Proposition 65	
					Acute Mammalian Toxicity	Carcinogenicity	Eye Irritation/Corrosion	Skin Irritation/Corrosion (Dermatotoxicity)	Germ Cell Mutagenicity	Target Organ Toxicity – Single Exposure	Target Organ Toxicity – Repeated Exposure	Reproductive/Developmental Toxicity	Sensitizer – Respiration ²	Sensitizer – Skin		Endocrine Disruptor
Phenylene diamine	Diaryl-p-phenylene diamine (DAPD is a class, main commercial DAPD is DTPD CASRN 68953-84-4)	68953-84-4		Cal OEHA, 2024; Danish EPA, 2023; Commission of the European Communities, 2001	Oral: Not Classified; Dermal: Not Classified; Inhalation: Not Classified	Not Classified	Not Classified	Not Classified	Not Classified	Not Classified	Not Classified	Cat. 2	DG	Cat. 1B	Not Listed (EU)	Not Listed
			55		0	0	0	0	0	0	0	25	5	25	0	0
Phenylene diamine	N,N'-Di-2-naphthyl-p-phenylenediamine (DNPA, CASRN 93-46-9)	93-46-9		Cal OEHA, 2024; Danish EPA, 2023; Commission of the European Communities, 2001	DG	DG	DG	DG	DG	DG	DG	DG	DG	DG	Not Listed (EU) though no data are available for this chemical	Not Listed
			Not assigned based on complete data gap													
Metal dithiocarbamate	Nickel dibutylthiocarbamate (NBC) ³	13927-77-0		ECHA, 2024; ToxServices, 2021h; Cal OEHA, 2024; Danish EPA, 2023; Commission of the European Communities, 2001	Oral: Not Classified; Dermal: Not Classified; Inhalation: Not Classified	Cat. 2 (ECHA, 2024); Cat. 1 (ToxServices, 2021h)	Cat. 2 (ECHA, 2024); Cat. 2A (ToxServices, 2021h)	Not Classified	Not Classified	Not Classified	DG (ECHA, 2024); Cat. 1 (ToxServices, 2021h)	Not Classified (ECHA, 2024); Cat. 2 Repro (ToxServices, 2021h)	DG (ECHA, 2024); Cat. 1B based on professional judgement even though compound is not a dermal sensitizer and does not trigger structural alerts (ToxServices, 2021h)	Not Classified	Not Listed (EU); DG (ToxServices, 2021h)	Carcinogen as Nickel Compound
			170		0	100	5	0	0	0	25	25	5	0	10	75 (see note 2)
Dihydroquinoline	Ethoxyquin	91-53-2		ECHA, 2024; ToxServices, 2021; Cal OEHA, 2024; Danish EPA, 2023; Commission of the European Communities, 2001	ECHA: Oral: Cat. 4; Dermal: Not Classified; Inhalation: DG ToxServices: Oral: Cat. 4; Dermal: Cat. 4; Inhalation: Cat. 4	Not Classified	Not Classified	Not Classified	Not Classified	Not Classified (ECHA, 2024); Cat. 1 (ToxServices, 2021)	Not Classified (ECHA, 2024); Cat. 1 (ToxServices, 2021)	Not Classified (ECHA, 2024); Cat. 2 (ToxServices, 2021)	DG	Not Classified (ECHA, 2024); Cat. 1B (ToxServices, 2021)	Not Listed (EU); Moderate based on "antiandrogenic effects, exhibited in an in vitro screening study of 200 pesticides, and some positive high throughput in vitro screening assays for estrogen receptor, androgen receptor, steroidogenesis, and thyroid receptor activities" and TEDX listing (ToxServices, 2021)	Not Listed
			135		5	0	0	0	0	25	25	25	5	25	25	0
Sulfur compound	Dilauryl thiodipropionate	123-28-4		ECHA, 2024; ToxServices, 2021; Cal OEHA, 2024; Danish EPA, 2023; Commission of the European Communities, 2001	Oral: Not Classified; Dermal: Not Classified; Inhalation: DG	DG (ECHA, 2024); Not classified based on modeling (ToxServices, 2021)	Not Classified	Not Classified	Not Classified	Not Classified	Not Classified	Not Classified	DG (ECHA, 2024); Not classified based on negative skin sensitization data (ToxServices, 2021)	Not Classified	Not Listed (EU); DG (ToxServices, 2021)	Not Listed
			40		0	25	0	0	0	0	0	0	5	0	10	0
Phenylene Diamine	N'-Phenyl-N-Fluorenyl-Para-Phenylenediamine	No CAS		Cal OEHA, 2024; Danish EPA, 2023; Commission of the European Communities, 2001	DG	DG	DG	DG	DG	DG	DG	DG	DG	DG	Not Listed (EU) though no data are available for this chemical	Not Listed
			Not assigned based on complete data gap													
Phenylene Diamine	N-(p-phenylthiomethylphenyl)-N'-(1,3-dimethyl-butyl)-p-phenylenediamine	No CAS		Cal OEHA, 2024; Danish EPA, 2023; Commission of the European Communities, 2001	DG	DG	DG	DG	DG	DG	DG	DG	DG	DG	Not Listed (EU) though no data are available for this chemical	Not Listed
			Not assigned based on complete data gap													
Phenylene Diamine	4-(2,5-dimethyl-1H-pyrrol-1-yl)-N-phenylaniline	No CAS		Cal OEHA, 2024; Danish EPA, 2023; Commission of the European Communities, 2001	DG	DG	DG	DG	DG	DG	DG	DG	DG	DG	Not Listed (EU) though no data are available for this chemical	Not Listed
			Not assigned based on complete data gap													
Phenylene Diamine	N,N - (ethane-1,2-diy) bis (N-phenylbenzene-1,4-diamine [example chemical from patent])	No CAS		Cal OEHA, 2024; Danish EPA, 2023; Commission of the European Communities, 2001	DG	DG	DG	DG	DG	DG	DG	DG	DG	DG	Not Listed (EU) though no data are available for this chemical	Not Listed
			Not assigned based on complete data gap													
Phenylene Diamine	4-N-(2,3-dimethylphenyl)-1-N-phenylbenzene-1,4-diamine- R1 and R2 are methyl	No CAS		Cal OEHA, 2024; Danish EPA, 2023; Commission of the European Communities, 2001	DG	DG	DG	DG	DG	DG	DG	DG	DG	DG	Not Listed (EU) though no data are available for this chemical	Not Listed
			Not assigned based on complete data gap													
Phenylene Diamine (Kruger)	RU997, Irgazone 997 (Reaction product of N-phenyl-N'-(1,3-dimethylbutyl)-p-phenylenediamine with an alkyl glycidylthioether)	444992-04-5		NZ Environmental Risk Management Authority, 2005; Cal OEHA, 2024; Danish EPA, 2023; Commission of the European Communities, 2001	DG	DG	DG	DG	DG	DG	DG	DG	DG	Irgazone 997: Skin sensitizer Cat. 1	Not Listed (EU) though no data are available for this chemical	Not Listed
			130		5	25	5	5	25	5	5	25	5	25	Not Listed (EU) though no data are available for this chemical	Not Listed
Phenylene Diamine	4-[(4-Methylpentan-2-ylamino)anilino]phenol	No CAS		Cal OEHA, 2024; Danish EPA, 2023; Commission of the European Communities, 2001	DG	DG	DG	DG	DG	DG	DG	DG	DG	DG	Not Listed (EU) though no data are available for this chemical	Not Listed
			Not assigned based on complete data gap													
Phenylene diamine	Representative example from class 4-(4-(dimethylamino)phenyl)amino)phenol	6358-22-1		Cal OEHA, 2024; Danish EPA, 2023; Commission of the European Communities, 2001	DG	DG	DG	DG	DG	DG	DG	DG	DG	DG	Not Listed (EU) though no data are available for this chemical	Not Listed
			Not assigned based on complete data gap													

Class of Compound	Chemical	CAS	Score ¹	Reference	Group A Endpoints										California Proposition 65	
					Acute Mammalian Toxicity	Carcinogenicity	Eye Irritation/Corrosion	Skin Irritation/Corrosion (Dermatotoxicity)	Germ Cell Mutagenicity	Target Organ Toxicity – Single Exposure	Target Organ Toxicity – Repeated Exposure	Reproductive/Developmental Toxicity	Sensitizer – Respiration ²	Sensitizer – Skin		Endocrine Disruptor
Dihydroquinoline	N,N-diethyl-2,2,4-trimethyl-1H-quinolin-6-amine (R = N(C ₂ H ₅) ₂)	No CAS		Cal OEHHA, 2023; Danish EPA, 2023; Commission of the European Communities, 2001	DG	DG	DG	DG	DG	DG	DG	DG	DG	DG	Not Listed (EU) though no data are available for this chemical	Not Listed
			Not assigned based on complete data gap													
Hindered amine	N,N'-Dibenzyl-p-xylene-alpha,alpha'-diamine-	25790-41-4		Cal OEHHA, 2024; Danish EPA, 2023; Commission of the European Communities, 2001	DG	DG	DG	DG	DG	DG	DG	DG	DG	DG	Not Listed (EU) though no data are available for this chemical	Not Listed
			Not assigned based on complete data gap													
Triazine	2,4,6-tris-(N-1,4-dimethylpentyl-phenylenediamino)-1,3,5-triazine (Durazone 37 or TAPDT)	121246-28-4		ECHA, 2024; Cal OEHHA, 2024; Danish EPA, 2023; Commission of the European Communities, 2001	Oral: Not Classified; Dermal: Not Classified; Inhalation: Not Classified	Not Classified	Not Classified	Not Classified	Not Classified	Not Classified	Not Classified	DG	Not Classified	Cat. 1B	Not Listed (EU)	Not Listed
			50	0	0	0	0	0	0	0	25	0	25	0	0	
Phenyl-naphthyl amines	N-Phenyl-1-naphthylamine	90-30-2		ECHA, 2024; Cal OEHHA, 2024; Danish EPA, 2023; Commission of the European Communities, 2001	Oral: Cat. 4; Dermal: Not Classified; Inhalation: DG	Not Classified	Not Classified	Not Classified	Not Classified	Not Classified	Cat. 2	Not Classified	DG	Cat. 1B	Not Listed (EU)	Not Listed
			45	5	0	0	0	0	0	10	5	25	0	0		
Phenyl-naphthyl amines	N-Phenyl-2-naphthylamine	135-88-6		ECHA, 2024; Cal OEHHA, 2024; Danish EPA, 2023; Commission of the European Communities, 2001	Oral: DG; Dermal: DG; Inhalation: DG	Cat. 2	Cat. 2	Cat. 2	DG	DG	DG	DG	DG	Cat. 1	Not Listed (EU)	Not Listed
			180	5	75	5	5	25	5	5	25	5	25	0	0	
Phenol	[2-Methyl-4,6-bis(octylthio)methyl]phenol (Irganox 1520) ⁴	110553-27-0		ECHA, 2024; Cal OEHHA, 2024; Danish EPA, 2023; Commission of the European Communities, 2001	Oral: Not Classified; Dermal: Not Classified; Inhalation: DG	DG	Not Classified	Not Classified	Not Classified	Not Classified	Not Classified	DG	Not Classified	Not Listed (EU)	Not Listed	
			30	0	25	0	0	0	0	0	0	5	0	0	0	
Inorganic	Graphene	1034343-98-0		ECHA, 2024; Cal OEHHA, 2024; Danish EPA, 2023; Commission of the European Communities, 2001	Oral: Not Classified; Dermal: DG; Inhalation: Not Classified	DG	Not Classified	Not Classified	Not Classified	Not Classified	DG	DG	Not Classified	Not Listed (EU)	Not Listed	
			55	0	25	0	0	0	0	25	5	0	0	0		
Hydrazine	1,1'-Pentamethylenebis(2,2-Di-n-Butylhydrazine)	No CAS		Cal OEHHA, 2024; Danish EPA, 2023; Commission of the European Communities, 2001	DG	DG	DG	DG	DG	DG	DG	DG	DG	DG	Not Listed (EU) though no data are available for this chemical	Not Listed
			Not assigned based on complete data gap													
Nitrene + Phenolic AO	α-C-4-hydroxy-3,5-dimethylphenyl-N-isopropyl and Lowinox WSP	Nitrene as a class, no CAS and Lowinox WSP - 77-62-3		ECHA, 2024; Cal OEHHA, 2024; Danish EPA, 2023; Commission of the European Communities, 2001	Oral: Not Classified; Dermal: Not Classified; Inhalation: Not Classified	Not Classified	Not Classified	Not Classified	Not Classified	Not Classified	Not Classified	DG	Not Classified	Not Listed (EU)	Not Listed	
			5	0	0	0	0	0	0	0	5	0	0	0		
Phenothiazine	N-(4-methylpentan-2-yl)-10H-phenothiazin-3-amine	No CAS		Cal OEHHA, 2024; Danish EPA, 2023; Commission of the European Communities, 2001	DG	DG	DG	DG	DG	DG	DG	DG	DG	DG	Not Listed (EU) though no data are available for this chemical	Not Listed
			Not assigned based on complete data gap													
Amine	7-(4-methylpentan-2-ylamino)-2,3,4,10-tetrahydro-1H-acridin-9-one	No CAS		Cal OEHHA, 2024; Danish EPA, 2023; Commission of the European Communities, 2001	DG	DG	DG	DG	DG	DG	DG	DG	DG	DG	Not Listed (EU) though no data are available for this chemical	Not Listed
			Not assigned based on complete data gap													

Class of Compound	Chemical	CAS	Score ¹	Reference	Group A Endpoints										California Proposition 65	
					Acute Mammalian Toxicity	Carcinogenicity	Eye Irritation/Corrosion	Skin Irritation/Corrosion (Dermatotoxicity)	Germ Cell Mutagenicity	Target Organ Toxicity – Single Exposure	Target Organ Toxicity – Repeated Exposure	Reproductive/Developmental Toxicity	Sensitizer – Respiration ²	Sensitizer – Skin		Endocrine Disruptor
Amine	2-cyclohexyl-N-(4-methylpentan-2-yl)-1H-indol-5-amine	No CAS		Cal OECHA, 2024; Danish EPA, 2023; Commission of the European Communities, 2001	DG	DG	DG	DG	DG	DG	DG	DG	DG	DG	Not Listed (EU) though no data are available for this chemical	Not Listed
			Not assigned based on complete data gap													
Amine	4-(1H-indol-2-yl)-N-(4-methylpentan-2-yl)aniline	None provided		Cal OECHA, 2024; Danish EPA, 2023; Commission of the European Communities, 2001	DG	DG	DG	DG	DG	DG	DG	DG	DG	DG	Not Listed (EU) though no data are available for this chemical	Not Listed
			Not assigned based on complete data gap													
Nitrone	α-C-4-Hydroxy-3,5-dimethylphenyl-N-tert-butyl nitrone	No CAS		Cal OECHA, 2024; Danish EPA, 2023; Commission of the European Communities, 2001	DG	DG	DG	DG	DG	DG	DG	DG	DG	DG	Not Listed (EU) though no data are available for this chemical	Not Listed
			Not assigned based on complete data gap													
Polymeric amine functionalized lignin	Amine functionalized lignin	No CAS		Cal OECHA, 2024; Danish EPA, 2023; Commission of the European Communities, 2001	DG	DG	DG	DG	DG	DG	DG	DG	DG	DG	Not Listed (EU) though no data are available for this chemical	Not Listed
			Not assigned based on complete data gap													
Gallate related	Rambutan peel extract	No CAS		Cal OECHA, 2024; Danish EPA, 2023; Commission of the European Communities, 2001	DG	DG	DG	DG	DG	DG	DG	DG	DG	DG	Not Listed (EU) though no data are available for this chemical	Not Listed
			Not assigned based on complete data gap													
Gallate related	Octyl gallate	1034-01-1	40	EFSA, 2015, ECHA, 2024 Cal OECHA, 2024; Danish EPA, 2023; Commission of the European Communities, 2001	Oral: Cat. 4; Dermal: DG Inhalation: DG	Not Classified	Cat. 1 (based on propyl gallate)	Not Classified (based on propyl gallate)	Not Classified (based on propyl gallate)	Not Classified	Not Classified (based on propyl gallate)	Not Classified	DG	Cat. 1	Not Listed (EU)	Not Listed
					5	0	5	0	0	0	0	0	5	25	0	
Gallate related	Nano calcium carbonate surface modified by gallic acid	No CAS		Cal OECHA, 2024; Danish EPA, 2023; Commission of the European Communities, 2001	DG	DG	DG	DG	DG	DG	DG	DG	DG	DG	Not Listed (EU) though no data are available for this chemical	Not Listed
			Not assigned based on complete data gap													
Phenylene Diamine	N-1-Methylheptyl-N'-phenyl-p-phenylenediamine (8PPD or UOP 688)	15233-47-3		Cal OECHA, 2024; Danish EPA, 2023; Commission of the European Communities, 2001	DG	DG	DG	DG	DG	DG	DG	DG	DG	DG	Not Listed (EU) though no data are available for this chemical	Not Listed
			Not assigned based on complete data gap													
Inorganic	Specialized carbon nanotube mixture	No CAS		Cal OECHA, 2024; Danish EPA, 2023; Commission of the European Communities, 2001	DG	DG	DG	DG	DG	DG	DG	DG	DG	DG	Not Listed (EU) though no data are available for this chemical	Not Listed
			Not assigned based on complete data gap													

Notes:

CAS = Chemical Abstracts Service Number; Cat. = Category; CLP = Classification, Labelling, and Packaging Regulation; DG = Data Gap; ECHA = European Chemicals Agency; EU = European Union; GHS = Globally Harmonized System of Classification and Labelling of Chemicals.

(1) This is assuming that the concentration of the chemical in the tire is <10%.

(2) ToxServices Greenscreen® assessments classified 6PPD and several potential alternatives as respiratory sensitizers based on dermal sensitization hazard, structural alert, and/or professional judgement. Gradient listed ToxService's hazard assignments, but did not score the endpoint based on respirator sensitization assignment. Instead, a data gap score was assigned. See report Section 5.1.2 for more details.

(3) NBC CAS 13927-77-0 is classified Cat. 1 for carcinogenicity under ToxServices GS, 2021 and Cat. 2 under ECHA dossier. It is also on California Prop 65 as a carcinogen. The highest score was counted (i.e., Cat. 1) and counted only once.

(4) A potential alternative is Irganox 1520 CAS 110553-27-0 blended with Vulcazon AFS. However, according to the source patent (Pirelli Tyre S.P.A, 2018), the best ratio is where 100% of blend is Irganox 1520. Additionally, no data were located for Vulcazon AFS. Thus, data and scoring is 100% based on Irganox 1520 CAS 110553-27-0.

Legend for Group A Hazards:

Cat. 1	Category 1 is most hazardous classification for all endpoints. For a minority of endpoints (i.e., acute mammalian and chronic aquatic toxicity), Category 4 is the least hazardous.
Cat. 2	For the rest of the endpoints, excluding physical endpoints, Category 2 is the least hazardous. "Not Classified" indicates no hazard according to endpoint-specific GHS criteria.
Cat. 3	Texts are underlined when information from difference sources result in different classifications. When there are different classifications for an endpoint, color and scoring are based on more conservative classifications.
Cat. 4	
Not Classified/Not Listed	Specific color-coding varies by health endpoint according to GreenScreen Chemical Hazard Criteria Section V - Annex 1 (Clean Production Action, 2018). In general, reds indicate very high and high hazards, yellow indicate moderate hazards, and green indicate no/low hazards. Data gaps are gray.
DG	

Table 5.2 Chemical-Specific Human Health Hazards (Group B Endpoints)¹

Chemical	CAS	Reference	Group B Endpoints										
			Respiratory Toxicity	Cardiovascular Toxicity	Epigenetic Toxicity	Hematotoxicity	Reactive in Biological Systems	Hepatotoxicity and Digestive System Toxicity	Immunotoxicity	Musculoskeletal Toxicity	Nephrotoxicity	Neurotoxicity	Ototoxicity
Current Priority Product Chemical of Concern													
N-(1,3-dimethylbutyl)-N'-phenyl-p-phenylenediamine (6PPD)	793-24-8	ECHA, 2024; ToxServices, 2021a, DTSC, 2022	May be a respiratory toxicant in Coho salmon (DTSC, 2022).	May be a vascular toxicant in Coho salmon (DTSC, 2022).	Not genotoxic; no other relevant data found	May induce anemia in rats at high doses, but dossier did not classify (ECHA, 2024).	DTSC lists 6PPDQ as reactive in biological systems in the Priority Product Profile	Increase in liver weight with fatty changes and vacuolar liver degeneration in rats, but dossier did not classify (ECHA, 2022).	Dermal sensitizer	DG	No relevant adverse effects observed	No relevant adverse effects observed in a 2 year oral study in rats (ECHA, 2024)	DG
Possible Alternatives													
N-(1,4-dimethylpentyl)-N'-phenyl-p-phenylenediamine (7PPD)	3081-01-4	ECHA, 2024	DG	DG	Not genotoxic; no other relevant data found	DG	Unclear	Increase in liver weight in rats; however, to not considered adverse in the absence of other effects. Dossier also did not classify.	Dermal sensitizer based on similar chemicals and structural alerts.	DG	DG	DG	DG
N-isopropyl-N'-phenyl-p-phenylenediamine (IPPD)	101-72-4	ECHA, 2024	Respiratory irritation were seen in subchronic animal studies, but dossier did not classify.	DG	Not genotoxic; no other relevant data found	Treatment related changes in several hematology parameters found in rats, but dossier did not classify.	Unclear	Increase in liver weight in rats; however, not considered adverse in the absence of other effects. Dossier also did not classify.	Dermal sensitizer	Incomplete skeletal ossification in rat offsprings; however, maternal toxicity was observed at the same dose, but dossier did not classify.	Increase kidney weight; however, not considered adverse in the absence of other effects. Dossier also did not classify.	DG	DG
N-cyclohexyl-N'-phenyl-p-phenylenediamine (CPPD)	101-87-1	-	DG	DG	DG	DG	Unclear	DG	DG	DG	DG	DG	DG
N,N'-diphenyl-p-phenylenediamine (DPPD)	74-31-7	ECHA, 2024	DG	DG	Mutagenic in <i>in vitro</i> assays, no <i>in vivo</i> data	Treatment related changes in several hematology parameters in rats, but dossier did not classify.	Unclear	Decrease in liver weight in rats; however, not considered adverse in the absence of other effects. Dossier also did not classify.	Dermal sensitizer	DG	Increase kidney weight and incidence of calcification, but dossier did not classify.	DG	DG
N-1,3-dimethyl butyl-N'-phenyl quinone diimine (6QDI)	52870-46-9	-	DG for all endpoints.										
Polymerized 2,2,4-trimethyl-1,2-dihydroquinoline (TMQ)	26780-96-1	ECHA, 2024	DG	DG	Not genotoxic; no other relevant data found.	DG	DG	Depressed liver function, fatty liver, enlarged liver, gross nodules in the liver in rats but dossier did not classify.	Not a dermal sensitizer. No other relevant data found.	In rat offsprings, statistically significant increase in skeletal abnormalities found in the presence of maternal toxicity. Dossier also did not classify.	DG	DG	DG
N,N'-Bis(1,4-dimethylpentyl)-p-phenylenediamine (77PD)	3081-14-9	ECHA, 2024	DG	DG	Not genotoxic; no other relevant data found	No relevant adverse effects observed	Unclear	Increase in liver weight in rats; however, not considered adverse in the absence of other effects. Dossier also did not classify.	Dermal sensitizer	No treatment-related skeletal abnormalities found in rabbits or rats.	No relevant adverse effects observed	DG	DG
4,4'-Diocetyl-diphenylamine (DOPD)	101-67-7	-	DG for all endpoints.										
N,N'-Ditolyl-p-phenylenediamine (Commercial DTPD)	68953-84-4	ECHA, 2024	DG	DG	Not genotoxic; no other relevant data found	Macrocytic anemia found in rats, but effects were reversible. Dossier did not classify.	Unclear	Increase in liver weight in rats; however, not considered adverse in the absence of other effects. Dossier also did not classify.	Dermal sensitizer	DG	Increase in kidney weight in rats; however not considered adverse in the absence of other effects. Dossier also did not classify.	DG	DG
N,N'-Dicyclohexyl-p-phenylenediamine (CCPD)	4175-38-6	-	DG	DG	DG	DG	Unclear	DG	DG	DG	DG	DG	DG
Diaryl-p-phenylene diamine (DAPD)	68953-84-4	ECHA, 2024	DG	DG	Not genotoxic; no other relevant data found	Macrocytic anemia found in rats, but effects were reversible. Dossier did not classify.	Unclear	Increase in liver weight in rats; however, not considered adverse in the absence of other effects. Dossier also did not classify.	Dermal sensitizer	DG	Increase in kidney weight in rats; however, not considered adverse in the absence of other effects. Dossier also did not classify.	DG	DG
N,N'-Di-2-naphthyl-p-phenylenediamine (DNPDA)	93-46-9	-	DG for all endpoints.										
Nickel dibutylthiocarbamate (NBC)	13927-77-0	ECHA, 2024; ToxServices, 2021h	DG	Dose-dependent degeneration of the heart muscles in rats with presence of fibrotic areas. Dossier did not classify.	Not genotoxic; no other relevant data found	Treatment related changes in several hematology parameters in rats. Dossier did not classify.	DG	Decreased liver weights, dose-dependent hyperemia in the liver. Dossier did not classify.	Histiocytosis in the parathyroid lymph nodes in rats. Not a dermal sensitizer.	Degeneration of skeletal muscle in rats accompanied by necrosis and mononuclear inflammation in high-dose males. Dossier did not classify.	No relevant adverse effects observed	DG	DG
Ethoxyquin	91-53-2	ECHA, 2024; ToxServices, 2021i	DG	DG	Not genotoxic; no other relevant data found	Treatment related changes in several hematology parameters in rats, but dossier did not classify.	DG	Adverse liver effects observed in rats and dogs, including hepatocellular necrosis, cytoplasmic vacuolation, and bile-duct hyperplasia. Dossier did not classify.	Weak dermal sensitizer in one animal study, but dossier did not classify.	DG	Dose-dependent nephropathy, regeneration of the tubular epithelium, renal tubular dilatation, and papillary necrosis in rats. Dossier did not classify.	Study authors of an acute inhalation study suggested potential neurotoxic effects based on tremors observed. Dossier did not classify.	DG
Dilauryl thiodipropionate	123-28-4	ECHA, 2024	DG	Inflammation of cardiac tissues at high dose, but ECHA dossier did not classify	Not genotoxic; no other relevant data found	No treatment-related adverse effects compared to historical control	DG	No relevant adverse effects observed	DG	No relevant adverse effects observed	DG	DG	DG
N'-Phenyl-N-Fluorenyl-Para-Phenylenediamine	No CAS	-	DG for all endpoints.										
N-(p-phenylthiomethylphenyl)-N'-(1,3 dimethylbutyl)-p-phenylenediamine	No CAS	-	DG for all endpoints.										
4-(2,5-dimethyl-1H-pyrrol-1-yl)-N-phenylamine	No CAS	-	DG for all endpoints.										
N,N'-(ethane-1,2-diyl) bis (N-phenylbenzene-1,4-diamine [example chemical from patent])	No CAS	-	DG for all endpoints.										

Chemical	CAS	Reference	Group B Endpoints										
			Respiratory Toxicity	Cardiovascular Toxicity	Epigenetic Toxicity	Hematotoxicity	Reactive in Biological Systems	Hepatotoxicity and Digestive System Toxicity	Immunotoxicity	Musculoskeletal Toxicity	Nephrotoxicity	Neurotoxicity	Ototoxicity
4-N-(2,3-dimethylphenyl)-1-N-phenylbenzene-1,4-diamine- R1 and R2 are methyl	No CAS	-	DG for all endpoints.										
RU997, Irgazone 997 (Reaction product of N-phenyl-N'-(1,3-dimethylbutyl)-p-phenylenediamine with an alkyl glycidylthioether)	444992-04-5	-	DG for all endpoints.										
4-[4-(4-Methylpentan-2-ylamino)anilino]phenol	No CAS	-	DG for all endpoints.										
Representative example from class 4-((4-(dimethylamino)phenyl)amino)phenol)	6358-22-1	-	DG for all endpoints.										
N,N-diethyl-2,2,4-trimethyl-1H-quinolin-6-amine (R= N(C2H5)2)	No CAS	-	DG for all endpoints.										
N,N'-Dibenzyl-p-xylene-alpha,alpha'-diamine-	25790-41-4	-	DG for all endpoints.										
2,4,6-tris-(N-1,4-dimethylpentyl-para-phenylenediamino)-1,3,5-triazine (Durazone 37 or TAPDT)	121246-28-4	-	DG for all endpoints.										
N-Phenyl-1-naphthylamine	90-30-2	ECHA, 2024	No reliable studies are located	DG	Not genotoxic; no other relevant data found	Hemolytic anemia found in rats. Dossier classified category 2.	DG	No reliable studies are located	Dermal sensitizer	No relevant adverse effects observed	Degeneration/regeneration of the proximal tubules in male rats and centrilobular hypertrophy in female rats, but dossier did not classify.	No relevant adverse effects observed	DG
N-Phenyl-2-naphthylamine	135-88-6	ECHA, 2024	DG	DG	DG	DG	DG	DG	Dermal sensitizer	DG	DG	DG	DG
[2-Methyl-4,6-bis((octylthio)methyl)phenol (Irganox 1520)] ²	110553-27-0	ECHA, 2024	DG	DG	Not genotoxic; no other relevant data found	No relevant adverse effects observed	DG	No relevant adverse effects observed	Not a dermal sensitizer. No other relevant data found.	No relevant adverse effects observed	DG	DG	DG
Graphene	1034343-98-0	ECHA, 2024	No relevant adverse effects observed	DG	Not genotoxic; no other relevant data found	DG	DG	DG	Not a dermal sensitizer. No other relevant data found.	DG	DG	DG	DG
1,1'-Pentamethylenebis(2,2-Di-n-Butylhydrazine)	No CAS	-	DG for all endpoints.										
α-C-4-hydroxy-3,5-dimethylphenyl-N-isopropyl and Lowinox WSP	Nitrone as a class, no CAS and Lowinox WSP - 77-62-3	ECHA, 2024	DG	No relevant adverse effects observed	Not genotoxic; no other relevant data found	No relevant adverse effects observed	DG	No relevant adverse effects observed	Not a dermal sensitizer. No other relevant data found.	DG	DG	No relevant adverse effects observed	DG
N-(4-methylpentan-2-yl)-10H-phenothiazin-3-amine	No CAS	-	DG for all endpoints.										
7-(4-methylpentan-2-ylamino)-2,3,4,10-tetrahydro-1H-acridin-9-one	No CAS	-	DG for all endpoints.										
2-cyclohexyl-N-(4-methylpentan-2-yl)-1H-indol-5-amine	No CAS	-	DG for all endpoints.										
4-(1H-indol-2-yl)-N-(4-methylpentan-2-yl)aniline	No CAS	-	DG for all endpoints.										
α-C-4-Hydroxy-3,5-dimethylphenyl-N-tert-butyl nitrone	No CAS	-	DG for all endpoints.										
Amine functionalized lignin	No CAS	-	DG for all endpoints.										
Rambutan peel extract	No CAS	-	DG for all endpoints.										

Chemical	CAS	Reference	Group B Endpoints											
			Respiratory Toxicity	Cardiovascular Toxicity	Epigenetic Toxicity	Hematotoxicity	Reactive in Biological Systems	Hepatotoxicity and Digestive System Toxicity	Immunotoxicity	Musculoskeletal Toxicity	Nephrotoxicity	Neurotoxicity	Ototoxicity	
Octyl Gallate	1034-01-1	EFSA, 2015; ECHA, 2024	DG	DG	Not genotoxic; no other relevant data found	Based on propyl gallate, reduction of hemoglobin concentration, packed cell volume and red blood cell concentration content and the morphological changes in the spleen, all at a high dose. The dossier did not classify on this endpoint.	Unclear	Based on propyl gallate, no relevant adverse effects observed	Dermal sensitizer	Based on propyl gallate, no relevant adverse effects observed	Based on propyl gallate, no relevant adverse effects observed	Based on propyl gallate, no relevant adverse effects observed	Based on propyl gallate, no relevant adverse effects observed	DG
Nano calcium carbonate surface modified by gallic acid	No CAS	-	DG for all endpoints.											
N-1-Methylheptyl-N'-phenyl-p-phenylenediamine (8PPD or UOP 688)	15233-47-3	-	DG for all endpoints.											
Specialized carbon nanotube mixture	No CAS	-	DG for all endpoints.											

Notes:

CAS = Chemical Abstracts Service Number; DG = Data Gap.

(1) This table presents the hazards of the individual product ingredients, which may not reflect the hazards of the actual final tire product when fully cured.

(2) A potential alternative is Irganox 1520 CAS 110553-27-0 blended with Vulcazon AFS. However, according to the source patent (Pirelli Tyre S.P.A, 2018), the best ratio is where 100% of blend is Irganox 1520. Additionally, no data were located for Vulcazon AFS. Thus, data and scoring is 100% based on Irganox 1520 CAS 110553-27-0.

Legend for Group B Hazards:

Potential Concern
No Relevant Adverse Effects Observed
DG

Table 5.3 Chemical-Specific Environmental and Physical Hazards

Chemical	CAS	Environmental Score ¹	Physical Score ¹	Reference	Environmental				Physical				
					Aquatic Toxicity – Acute	Aquatic Toxicity – Chronic	Persistent	Bioaccumulation	Terrestrial Ecotoxicity (from Pharos Only)	Global Warming Potential	Ozone Depleting Potential	CAA VOC Contributing to Smog Formation	Flammability
Current Priority Product Chemical of Concern													
N-(1,3-dimethylbutyl)-N'-phenyl-p-phenylenediamine (6PPD)	793-24-8			ECHA, 2024; ToxServices GreenScreen, 2021a; PubChem, 2023; US EPA, 2018; IPCC, 2013	Cat. 1	Cat. 1	ECHA (2024): Not readily biodegradable in water (2% in 28 days), however half-life in freshwater is 2.9 hours. Strong absorption to soil; ToxServices (2021a): Persistent, modeled half-life in soil is 1,800 hours (75 days)	ECHA (2024): BCF of 569 (QSAR) which would be considered not bioaccumulative under California Code of Regulations, according to title 22, Division 4.5, Chapter 54, Article 5. 6PPD hydrolyzes in water with half-life of 8 hours. Hydrolysis products 4-hydroxydiphenylamine (experimental BCF 3.3-40 in Cyprinus carpio), n-phenyl-p-benzoquinone monoimine (experimental BCF in Cyprinus carpio is <1.2-23), and 1,3-dimethylbutylamine (experimental BCF in Cyprinus carpio is <1.7-17) are all not bioaccumulative (ECHA, 2024); ToxServices (2021a): Bioaccumulative based on measured BCFs of 1,500-1,700 for the surrogate N-(1-methylheptyl)-N'-phenylbenzene-1,4-diamine (CAS 15233-47-3).	DG	No	No	Not a VOC (low vapor pressure)	Not Classified
		150	0		25	25			50	50	0	0	0
Possible Alternatives													
N-(1,4-dimethylpentyl)-N'-phenyl-p-phenylenediamine (7PPD)	3081-01-4			ECHA, 2024; ToxServices GreenScreen, 2021b; US EPA, 2018; IPCC, 2013	Cat. 1	Cat. 1	ECHA (2024): Not readily biodegradable in water (0% degraded in 35 days). Half-life in aerobic soil is <45.6 hours (1.9 days). Strong absorption to soil. ToxServices (2021b): Persistent, modeled half-life in soil is 75 days	ECHA (2024): BCF of 1197 L/kg (QSAR) which would be considered bioaccumulative under California Code of Regulations, according to title 22, Division 4.5, Chapter 54, Article 5. However, 7PPD hydrolyzes in water (pH 7, 20C) with half-life of 7 hours. Hydrolysis products of 7PPD, 4-anilinophenol, (4-hydroxydiphenylamine) (experimental BCF 3.3-49) and its oxidized form N-Phenylphenyl-p-benzoquinone monoimine (BCF <1.2 - 23), are not bioaccumulative. ToxServices (2021b): Bioaccumulative based on measured BCFs of 1,500-1,700 for the surrogate N-(1-methylheptyl)-N'-phenylbenzene-1,4-diamine (CAS 15233-47-3).	DG	No	No	Not a VOC (low vapor pressure)	Not Classified
		150	0		25	25			50	50	0	0	0
N-isopropyl-N'-phenyl-p-phenylenediamine (IPPD)	101-72-4			ECHA, 2024; ToxServices GreenScreen, 2021c; PubChem, 2023; US EPA, 2018; IPCC, 2013	Cat. 1	Cat. 1	ECHA (2024): Not readily biodegradable in water (18.9% degraded in 32 days). Half-life in Mississippi river water is 2.5 hours. Moderate absorption to soil. ToxServices (2021c): Persistent, modeled half-life in soil is 75 days.	ECHA (2024): BCF of 31.2 (QSAR) which is considered not bioaccumulative under California Code of Regulations, according to title 22, Division 4.5, Chapter 54, Article 5. IPPD hydrolyzes in water with half-life of 2.5 hours. Hydrolysis products of IPPD, 4-hydroxydiphenylamine (experimental BCF 3.3-49) and p-quinoneimine-N-phenyl (BCF <1.2 - 23), are not bioaccumulative. ToxServices (2021c): Very low bioaccumulation based on measured log kow (2.77).	DG	No	No	Not a VOC (low vapor pressure)	Not Classified
		100	0		25	25			50	0	0	0	0
N-cyclohexyl-N'-phenyl-p-phenylenediamine (CPPD)	101-87-1			US EPA, 2023b; US EPA, 2018; IPCC, 2013	DG	DG	DG	DG	DG	No	No	Not a VOC (low vapor pressure)	DG
		Not assigned based on complete data gap	0							0	0	0	0
N,N'-diphenyl-p-phenylenediamine (DPPD)	74-31-7			ECHA, 2024; PubChem, 2023; US EPA, 2018; IPCC, 2013	Cat. 1	Cat. 1	Not readily biodegradable in water (0.2% degraded in 14 days). A dissipation half-life (DT50) of 187.46 years (QSAR).	BCF of 260-2,150 derived in Cyprinus carpio from an experimental OECD 305C study. Given the bioconcentration threshold (BCF/BAF = 1000) under California Code of Regulations, according to title 22, Division 4.5, Chapter 54, Article 5, DPPD's BCFs straddles both bioaccumulative and not bioaccumulative. DPPD is conservatively classified as bioaccumulative.	DG	No	No	Not a VOC (low vapor pressure)	Not Classified
		150	0		25	25			50	50	0	0	0
N-1,3-dimethyl butyl-N'-phenyl quinone diimine (6QDI)	52870-46-9			ECHA, 2024; ToxServices GreenScreen, 2021d; US EPA, 2023b; US EPA, 2018; IPCC, 2013; ECHA Harmonized CLP, 2023	Cat. 1	Cat. 1	DG (ECHA, 2024): Persistent based on estimated half-life of 337.5 days in sediment, its predicted dominant environmental compartment (ToxServices, 2021d)	DG (ECHA, 2024): Bioaccumulative based on measured BCFs of 1,500-1,700 for the surrogate N-(1-methylheptyl)-N'-phenylbenzene-1,4-diamine (CAS 15233-47-3).	DG	No	No	Not a VOC (low vapor pressure)	Not Classified
		150	0		25	25			50	50	0	0	0
Polymerized 2,2,4-trimethyl-1,2-dihydroquinoline (TMQ Oligomer)	147-47-7			ECHA, 2024; ToxServices GreenScreen, 2021e; US EPA, 2023b; US EPA, 2018; IPCC, 2013	Cat. 2 based on surrogate Ethoxyquin CAS 91-53-2 (ToxServices, 2021e); No data (ECHA, 2024)	Cat. 2 based on modeled data (ToxServices, 2021e); Cat. 3 (ECHA, 2024)	Persistent based on modeled half-life in soil is 75 days (ToxServices, 2021e); No biodegradation of TMQ was observed in 28 days in an EU Method C.4-E test (ECHA, 2024).	Very low bioaccumulative potential based on measured log kow of 2.93 (ToxServices, 2021e); Not bioaccumulative based on BCF between 108 and 1300 in Cyprinus carpio based on OECD 305C test (ECHA, 2024).	DG	No	No	Not a VOC (low vapor pressure)	Not Classified
		70	0		10	10			50	0	0	0	0

Chemical	CAS	Environmental Score ¹	Physical Score ¹	Reference	Environmental					Physical			
					Aquatic Toxicity – Acute	Aquatic Toxicity – Chronic	Persistent	Bioaccumulation	Terrestrial Ecotoxicity (from Pharos Only)	Global Warming Potential	Ozone Depleting Potential	CAA VOC Contributing to Smog Formation	Flammability
N,N'-Bis(1,4-dimethylpentyl)-p-phenylenediamine (77PD)	3081-14-9			ECHA, 2024; ToxServices GreenScreen, 2021f; US EPA, 2018; IPCC, 2013	Cat. 1	Cat. 1	ECHA (2024): Not readily biodegradable in water (12% in 28 days). ToxServices (2021f): Persistent based on a degradation of 12% in 28 days in an OECD 301C study and 50% in 35 days in an OECD 301B study. Half-life in soil is 75 days, which is the dominant medium according to modeling.	ECHA (2024): Not bioaccumulative. 77PD's half-life in water is 3.6 hours. The BCFs for the primary hydrolysis products of 77PD are all below California Code of Regulations title 22, Division 4.5, Chapter 54, Article 5, bioconcentration threshold of BCF/BAF = 1000. ToxServices (2021f): Bioaccumulative under GHS based on a modeled BAF of 614.6. However, this BAF is not considered bioaccumulative under California Code of Regulations title 22, Division 4.5, Chapter 54, Article 5.	DG	No	No	Not a VOC (low vapor pressure)	Not Classified
		100	0		25	25	50	0	0	0	0	0	
4,4'-Dioctyldiphenylamine (DOPD)	101-67-7			US EPA, 2023b; US EPA, 2018; IPCC, 2013	DG	DG	DG	DG	DG	No	No	Not a VOC (low vapor pressure)	DG
		Not assigned based on complete data gap	0							0	0	0	0
N,N'-Ditoly-p-phenylenediamine (Commercial DTPD)	68953-84-4			ECHA, 2024; US EPA, 2018; IPCC, 2013	Cat. 1	Cat. 1	Persistent based on negligible biodegradation in multiple studies.	Bioaccumulative based on measured BCF of 2107 in rainbow trout.	DG	No	No	Not a VOC (low vapor pressure)	Not Classified
		150	0		25	25	50	50	0	0	0	0	0
N,N'-Dicyclohexyl-p-phenylenediamine (CCPD)	4175-38-6			ToxServices, 2021g; US EPA, 2023b; US EPA, 2018; IPCC, 2013	Cat. 1 based on surrogate 44PD	Cat. 1 based on surrogate 44PD	Persistent based on modeled half-life of 75 days in soil, which is the primary partitioning compartment.	Bioaccumulative based on modeled BAF of 1059.	DG	No	No	Not a VOC (low vapor pressure)	Not Classified
		150	0		25	25	50	50	0	0	0	0	0
Diaryl-p-phenylene diamine (DAPD is a class, main commercial DAPD is DTPD CASRN 68953-84-4)	68953-84-4			ECHA, 2024; US EPA, 2018; IPCC, 2013	Cat. 1	Cat. 1	Persistent based on negligible biodegradation in multiple studies.	Bioaccumulative based on measured BCF of 2107 in rainbow trout.	DG	No	No	Not a VOC (low vapor pressure)	Not Classified
		150	0		25	25	50	50	0	0	0	0	0
N,N'-Di-2-naphthyl-p-phenylenediamine (DNPPA)	93-46-9			US EPA, 2023b; US EPA, 2018; IPCC, 2013	DG	DG	DG	DG	DG	No	No	Not a VOC (low vapor pressure)	DG
		Not assigned based on complete data gap	0							0	0	0	0
Nickel dibutylthiocarbamate (NBC)	13927-77-0			ECHA, 2024; ToxServices GreenScreen, 2021h; US EPA, 2018; IPCC, 2013	Not Classified	ECHA (2024): Chronic 4 ToxServices (2021h): Not classified	Persistent based on a degradation of 0% at day 28 in an OECD 301B test.	ECHA (2024): Not bioaccumulative based on a modeled BCF of 75.96 L/kg ToxServices (2021h): Not bioaccumulative. BCFs are between 100 and 500	DG	No	No	Not a VOC (low vapor pressure)	Not Classified
		50	0		0	0	50	0	0	0	0	0	0
Ethoxyquin	91-53-2			ECHA, 2024; ToxServices GreenScreen, 2021i; US EPA, 2018; IPCC, 2013	ECHA (2024): Not classified ToxServices (2021i): Cat. 2	Cat. 2	ECHA (2024): Not readily biodegradable (QSAR) ToxServices (2021i): Not readily biodegradable and partitioning to the soil with a half-life of 75 days.	ECHA (2024): Not bioaccumulative based on a modeled BCF of 455.8 L/kg ToxServices (2021i): Very low for bioaccumulation based on a measured log Kow value of 3.39 at pH 7 and an estimated BCF value of 129.3	DG	No	No	Not a VOC (low vapor pressure)	Not Classified
		70	0		10	10	50	0	0	0	0	0	0
Dilauryl thiodipropionate	123-28-4			ECHA, 2024; ToxServices GreenScreen, 2021j; US EPA, 2018; IPCC, 2013	Not Classified	Not Classified	Readily biodegradable based on 82% degraded in 28 days in an OECD 301C study.	Not bioaccumulative based on a modeled BCF of 7.43 (ECHA, 2024) and modeled BAG of 1.078 (ToxServices, 2021i)	DG	No	No	Not a VOC (low vapor pressure)	Not Classified
		0	0		0	0	0	0	0	0	0	0	0
N'-Phenyl-N-Fluorenyl-Para-Phenylenediamine	No CAS			US EPA, 2018; IPCC, 2013; US EPA EPISuite, 2019	DG	DG	DG	DG	DG	No	No	Not a VOC (low vapor pressure)	DG
		Not assigned based on complete data gap	0							0	0	0	0
N-(p-phenylthiomethylphenyl)-N'-(1,3 dimethyl-butyl)-p-phenylenediamine	No CAS			US EPA, 2018; IPCC, 2013; US EPA EPISuite, 2019	DG	DG	DG	DG	DG	No	No	Not a VOC (low vapor pressure)	DG
		Not assigned based on complete data gap	0							0	0	0	0
4-(2,5-dimethyl-1H-pyrrol-1-yl)-N-phenylaniline	No CAS			US EPA, 2018; IPCC, 2013; US EPA EPISuite, 2019	DG	DG	DG	DG	DG	No	No	Not a VOC (low vapor pressure)	DG
		Not assigned based on complete data gap	0							0	0	0	0

Chemical	CAS	Environmental Score ¹	Physical Score ¹	Reference	Environmental					Physical			
					Aquatic Toxicity – Acute	Aquatic Toxicity – Chronic	Persistent	Bioaccumulation	Terrestrial Ecotoxicity (from Pharos Only)	Global Warming Potential	Ozone Depleting Potential	CAA VOC Contributing to Smog Formation	Flammability
N,N - (ethane-1,2-diyl) bis (N-phenylbenzene-1,4-diamine or similar chemical 1-N-[2-(4-anilinoanilino)ethyl]-4-N-phenylbenzene-1,4-diamine	No CAS			US EPA, 2018; IPCC, 2013; US EPA EPI Suite, 2019	DG	DG	DG	DG	DG	No	No	Not a VOC (low vapor pressure)	DG
		Not assigned based on complete data gap	0							0	0	0	
4-N-(2,3-dimethylphenyl)-1-N-phenylbenzene-1,4-diamine-R1 and R2 are methyl	No CAS			US EPA, 2018; IPCC, 2013; US EPA EPI Suite, 2019	DG	DG	DG	DG	DG	No	No	Not a VOC (low vapor pressure)	DG
		Not assigned based on complete data gap	0							0	0	0	
RU997 Irgazone 997 Reaction product of N-phenyl-N'-(1,3dimethylbutyl)-p-phenylenediamine with an alkyl glycidylthioether.	444992-04-5			NZ Environmental Risk Management Authority, 2005; US EPA, 2023b; US EPA EPI Suite, 2019	Irgazone 997: Cat. 3	DG	DG	DG	DG	No	No	Not a VOC (low vapor pressure)	DG
		65	0		5	10	25	25	0	0	0		
4-[4-(4-Methylpentan-2-ylamino)anilino]phenol	No CAS			US EPA, 2018; IPCC, 2013; US EPA EPI Suite, 2019	DG	DG	DG	DG	DG	No	No	Not a VOC (low vapor pressure)	DG
		Not assigned based on complete data gap	0							0	0	0	
This is a class of compounds - Reference uses case where R1 and R2 are methyl; n,p and q are zero and m=1 and is in the para position . Representative example from class 4-((4-(dimethylamino)phenyl)amino)phenol)	6358-22-1			US EPA, 2018; IPCC, 2013; US EPA EPI Suite, 2019	DG	DG	DG	DG	DG	No	No	Not a VOC (low vapor pressure)	DG
		Not assigned based on complete data gap	0							0	0	0	
N,N-diethyl-2,2,4-trimethyl-1H-quinolin-6-amine (R= N(C2H5)2	No CAS			US EPA, 2018; IPCC, 2013; US EPA EPI Suite, 2019	DG	DG	DG	DG	DG	No	No	Not a VOC (low vapor pressure)	DG
		Not assigned based on complete data gap	0							0	0	0	
Mixed xylene diamines N,N'-Dibenzyl-p-xylene-alpha,alpha'-diamine- 25790-41-4	25790-41-4			US EPA, 2018; IPCC, 2013; US EPA EPI Suite, 2019; US EPA, 2023b	DG	DG	DG	DG	DG	No	No	Not a VOC (low vapor pressure)	CompTox: Flashpoint: 94.3°C
		Not assigned based on complete data gap	0						0	0	0	0	
2,4,6-tris-(N-1,4-dimethylpentyl-para-phenylenediamino)-1,3,5-triazine, TAPDT	121246-28-4			ECHA (2024); US EPA, 2018; IPCC, 2013	Cat. 1	Cat. 1	ECHA (2024): Not readily biodegradable based on 18% degradation in water at 28 days (OECD TG 301B)	ECHA (2024): Not bioaccumulative based on a modeled BCF average of 16 L/Kg (QSAR)	DG	No	No	Not a VOC (low vapor pressure)	ECHA (2024): Not Classified
		100	0		25	25	50	0	0	0	0	0	
N-Phenyl-1-naphthylamine	90-30-2			ECHA (2024); US EPA, 2018; IPCC, 2013	Cat. 1	Cat. 1	ECHA (2024): Not readily biodegradable based on 0% degradation water at 28 days in an OECD TG 301C study (Kanne 1980 as cited in ECHA, 2024). Similar results were reported 1t 14 days in an OECD TG 301C study (MITI Database, 2002 as cited in ECHA, 2024). Inherent biodegradation observed in a CO2 evolution study following a US EPA recommendation, 50% degradation was reported within 5 days in sewage effluent and >75% and 100% degradation within 2 and 10 days, respectively in supplemented sewage sludge (Sikka <i>et al.</i> , 1981, as cited in ECHA, 2024). For lake water, 50% degradation after 5 days and > 90% degradation after 18 days were observed.	ECHA (2024): BCF values ranging from 427 to 2490; Bioaccumulative based on the upper end BCF range for fish (OECD TG 305C).	DG	No	No	Not a VOC (low vapor pressure)	Not Classified
		150	0		25	25	50	50	0	0	0	0	0
N-Phenyl-2-naphthylamine	135-88-6			ECHA (2024); US EPA, 2018; IPCC, 2013	DG	Cat. 2	DG	Not bioaccumulative based Log Pow of 23C	DG	No	No	Not a VOC (low vapor pressure)	Not Classified
		45	0		10	10	25	0	0	0	0	0	

Chemical	CAS	Environmental Score ¹	Physical Score ¹	Reference	Environmental					Physical			
					Aquatic Toxicity – Acute	Aquatic Toxicity – Chronic	Persistent	Bioaccumulation	Terrestrial Ecotoxicity (from Pharos Only)	Global Warming Potential	Ozone Depleting Potential	CAA VOC Contributing to Smog Formation	Flammability
[2-Methyl-4,6-bis((octylthio)methyl)phenol (Irganox 1520) ²	110553-27-0			ECHA (2024); US EPA, 2018; IPCC, 2013	Not Classified	Not Classified	ECHA (2024): Not readily biodegradable based on 4% degradation in water at 28 days (OECD TG 301B). ECHA (2024): Moderately biodegradable based on the DT50 = 0.33 - 0.43 days in water/sediment (OECD TG 308).	ECHA (2024): Not bioaccumulative based on a measured BCF of 36 L/Kg in fish (OECD TG 305)	DG	No	No	Not a VOC (low vapor pressure)	Not Classified
		10	0		0	0	10	0	0	0	0	0	
Graphene	1034343-98-0			ECHA (2024); US EPA, 2018; IPCC, 2013	Cat. 3	Cat. 3	Inorganic; In a ready biodegradability test (OECD 301D), graphene degraded 0% by % ThCOD in 28 days.	Inorganic, no BCF or Log kow data	DG	No	No	DG	Not Classified
		85	0		5	5	50	25	0	0	0	0	
1,1'-Pentamethylenebis(2,2-Di-n-Butylhydrazine)	No CAS			US EPA, 2018; IPCC, 2013	DG	DG	DG	DG	DG	No	No	Not a VOC (low vapor pressure)	DG
		Not assigned based on complete data gap	0					0		0	0	0	
α-C-4-hydroxy-3,5-dimethylphenyl-N-isopropyl and Lowinox WSP CAS 77-62-3	Nitrone as a class, no CAS and Lowinox WSP - 77-62-3			ECHA (2024); US EPA, 2018; IPCC, 2013	Lowinox WSP: Not Classified	Lowinox WSP ECHA (2024): Cat. 4	Lowinox WSP ECHA (2024): Persistent based on results of an OECD 301B study. Degradation of Lowinox WSP was 10-12% at 28 days. The degradation did not reach criteria for ready biodegradability (60% COD within a 10 day window).	DG	DG	No	No	Not a VOC (low vapor pressure)	Not Classified
		75 for Lowinox WSP, complete data gap for nitrone as a class	0		0	0	50	25		0	0	0	0
N-(4-methylpentan-2-yl)-10H-phenothiazin-3-amine	No CAS			US EPA, 2018; IPCC, 2013; US EPA EPISuite, 2019	DG	DG	DG	DG	DG	No	No	Not a VOC (low vapor pressure)	DG
		Not assigned based on complete data gap	0							0	0	0	
7-(4-methylpentan-2-ylamino)-2,3,4,10-tetrahydro-1H-acridin-9-one	No CAS			US EPA, 2018; IPCC, 2013; US EPA EPISuite, 2019	DG	DG	DG	DG	DG	No	No	Not a VOC (low vapor pressure)	DG
		Not assigned based on complete data gap	0							0	0	0	
2-cyclohexyl-N-(4-methylpentan-2-yl)-1H-indol-5-amine	No CAS			US EPA, 2018; IPCC, 2013; US EPA EPISuite, 2019	DG	DG	DG	DG	DG	No	No	Not a VOC (low vapor pressure)	DG
		Not assigned based on complete data gap	0							0	0	0	
4-(1H-indol-2-yl)-N-(4-methylpentan-2-yl)aniline	No CAS			US EPA, 2018; IPCC, 2013; US EPA EPISuite, 2019	DG	DG	DG	DG	DG	No	No	Not a VOC (low vapor pressure)	DG
		Not assigned based on complete data gap	0							0	0	0	
α-C-4-Hydroxy-3,5-dimethylphenyl-N-tert. butyl nitrone	No CAS			US EPA, 2018; IPCC, 2013	DG	DG	DG	DG	DG	No	No	DG	DG
		Not assigned based on complete data gap	0							0	0	0	
Amine functionalized lignin	No CAS			US EPA, 2018; IPCC, 2013	DG	DG	DG	DG	DG	No	No	DG	DG
		Not assigned based on complete data gap	0							0	0	0	
Rambutan peel extract	No CAS			US EPA, 2018; IPCC, 2013	DG	DG	DG	DG	DG	No	No	DG	DG
		Not assigned based on complete data gap	0							0	0	0	
Octyl gallate	1034-01-1			ECHA, 2024; US EPA, 2018; IPCC, 2013	Cat. 1 (based on propyl gallate)	Cat. 1 (based on propyl gallate)	Based on propyl gallate, persistent based on results of an OECD 301F study. Degradation of propyl gallate was 49.4% at 28 days. The degradation did not reach criteria for ready biodegradability (60% ThOD within a 10 day window).	Not bioaccumulative based on modeled log Kow of 3.66.	DG	No	No	Not a VOC (low vapor pressure)	Not Classified (based on propyl gallate)
		100	0		25	25	50	0		0	0	0	0

Chemical	CAS	Environmental Score ¹	Physical Score ¹	Reference	Environmental					Physical			
					Aquatic Toxicity – Acute	Aquatic Toxicity – Chronic	Persistent	Bioaccumulation	Terrestrial Ecotoxicity (from Pharos Only)	Global Warming Potential	Ozone Depleting Potential	CAA VOC Contributing to Smog Formation	Flammability
Nano calcium carbonate surface modified by gallic acid	No CAS			US EPA, 2018; IPCC, 2013	DG	DG	DG	DG	DG	No	No	DG	DG
		Not assigned based on complete data gap	0						0	0	0		
N-1-Methylheptyl-N'-phenyl-p-phenylenediamine (8PPD or UOP 688)	15233-47-3			US EPA, 2018; IPCC, 2013	DG	DG	DG	DG	DG	No	No	Not a VOC (low vapor pressure)	DG
		Not assigned based on complete data gap	0						0	0	0		
Specialized carbon nanotube mixture	No CAS			US EPA, 2018; IPCC, 2013	DG	DG	DG	DG	DG	No	No	DG	DG
		Not assigned based on complete data gap	0						0	0	0		

Notes:

BCF = Bioconcentration Factor; CAA = Clean Air Act; CAS = Chemical Abstracts Service Number; COD = Chemical oxygen demand; DG = Data Gap; ECHA = European Chemicals Agency; GHS = Globally Harmonized System of Classification and Labelling of Chemicals; GWP = Global Warming Potential; K_{ow} = Octanol-Water Partition Coefficient; OECD = The Organisation for Economic Co-operation and Development; ODP = Oxygen-Depleting Potential; TG = Test Guideline; ThCOD = Theoretical chemical oxygen demand; ThOD = Theoretical oxygen demand; TSCA = Toxic Substances Control Act; US EPA = United States Environmental Protection Agency; VOC = Volatile Organic Compound.

Ingredients are considered bioaccumulative if BCF is >1,000 according to California Code of Regulations, according to title 22, Division 4.5, Chapter 54, Article 5 (Cal OEHHA, 2012). US EPA's list of ozone-depleting substances (US EPA, 2018) was used to evaluate ODP. Pharos (Healthy Building Network, 2023) was used to inform terrestrial toxicity. GWP was evaluated using Table 8.a.1 of the IPCC 5th Technical Report (IPCC, 2013). VOCs were considered chemicals with vapor pressures equal to or greater than 0.1 mm mercury (Hg) at 20C based on criteria in CARB (2009). Additionally, we noted whether the chemical is listed as a substance exempted under 40 CFR § 51.100 (CARB, 2009).

(1) This is assuming that the concentration of the chemical in the tire is <10%.

(2) A potential alternative is Irganox 1520 CAS 110553-27-0 blended with Vulcazon AFS. However, according to the source patent (Pirelli Tyre S.P.A, 2018), the best ratio is where 100% of blend is Irganox 1520. Additionally, no data were located for Vulcazon AFS. Thus, data and scoring is 100% based on Irganox 1520 CAS 110553-27-0.

Legend:

Categories assigned according to ECHA dossiers (ECHA, 2024) and Pharos (Healthy Building Network, 2023). Texts are underlined when information from difference sources result in different classifications. When there are different classifications for an endpoint, color and scoring are based on more conservative classifications.

Specific color coding varies by endpoint according to GreenScreen Chemical Hazard Criteria Section V - Annex 1 (Clean Production Action, 2018). In general, reds indicate very high and high hazards, yellow indicate moderate hazards, and green indicate no/low hazards. Data gaps are gray.

Category 1	Category 1 is most hazardous classification for all endpoints. For a minority of endpoints (i.e., chronic aquatic toxicity), Category 4 is the least hazardous. For the rest of the endpoints, excluding physical endpoints, Category 2 is the least hazardous. Not classified indicated no hazard according to endpoint-specific GHS criteria.
Category 2	
Category 3	
Category 4	
Category 5	

Table 5.4 Acute Toxicity Data in Salmonids Reported in Existing Scientific Literature

Chemical Name	CAS No.	Species	Parent Compound		Quinone		Citations
			Acute LC ₅₀ (Lowest Reported) (Flow Conditions, Exposure Measurement)	Duration of Exposure	Acute LC ₅₀ (Lowest Reported) (Flow Conditions, Exposure Measurement)	Duration of Exposure	
			µg/L	hr	µg/L	hr	
N-(1,3-dimethylbutyl)-N'-phenyl-p-phenylenediamine (6PPD)	793-24-8	Pink salmon (<i>Oncorhynchus gorbuscha</i>), juvenile	N/A	N/A	>12.8 (static, measured)	48	Foldvik <i>et al.</i> , 2024
		Chum salmon (<i>Oncorhynchus keta</i>), juvenile	N/A	N/A	>1.3-2.4 (static, estimated in 320 mg/L tire wear particle leachate)	24	McIntyre <i>et al.</i> , 2021
		Coho salmon (<i>Oncorhynchus kisutch</i>), juvenile	250 (flow-through, measured)	24	0.041 (static, measured)	24	Tian <i>et al.</i> , 2021; Lo <i>et al.</i> , 2023
		Landlocked masu salmon (<i>Oncorhynchus masou masou</i>), juvenile	N/A	N/A	>3.5 (static, measured)	96	Hiki and Yamamoto, 2022
		Rainbow trout (<i>Oncorhynchus mykiss</i>), juvenile	140 (static, nominal)	96	0.64 (static, measured)	96	Monsanto Co., 1977, as cited in EcoTox, 2023; Nair <i>et al.</i> , 2023
		Sockeye salmon (<i>Oncorhynchus nerka</i>)	N/A	N/A	>50 (flow-through, measured)	24	Greer <i>et al.</i> , 2023
		Chinook salmon (<i>Oncorhynchus tshawytscha</i>)	N/A	N/A	67 (flow and measurement not specified)	N/R	Lo <i>et al.</i> , 2023
		Atlantic salmon (<i>Salmo salar</i>)	N/A	N/A	>12.16 (static, measured)	48	Foldvik <i>et al.</i> , 2022
		Brown Trout (<i>Salmo trutta</i>)	N/A	N/A	>12.16 (static, measured)	48	Foldvik <i>et al.</i> , 2022
		Arctic char (<i>Salvelinus alpinus</i>)	N/A	N/A	>14.2 (static, measured)	96	Brinkmann <i>et al.</i> , 2022
		Southern Asian dolly varden (<i>Salvelinus curilus</i>)	N/A	N/A	>3.8 (static, measured)	96	Hiki and Yamamoto, 2022
		Brook trout (<i>Salvelinus fontinalis</i>)	N/A	N/A	0.59 (static, measured)	24	Brinkmann <i>et al.</i> , 2022
		White-spotted char (<i>Salvelinus leucomaenis pluvius</i>)	N/A	N/A	0.51 (static, measured)	24	Hiki and Yamamoto, 2022
		N-(1,4-dimethylpentyl)-N'-phenyl-p-phenylenediamine (7PPD)	3081-01-4	Pink salmon (<i>Oncorhynchus gorbuscha</i>), juvenile	N/A	N/A	N/A
Chum salmon (<i>Oncorhynchus keta</i>), juveniles	N/A			N/A	N/A	N/A	
Coho salmon (<i>Oncorhynchus kisutch</i>), juvenile	N/A			N/A	N/A	N/A	
Landlocked masu salmon (<i>Oncorhynchus masou masou</i>), juvenile	N/A			N/A	N/A	N/A	
Rainbow trout (<i>Oncorhynchus mykiss</i>)	N/A			N/A	N/A	N/A	
Sockeye salmon (<i>Oncorhynchus nerka</i>)	N/A			N/A	N/A	N/A	
Chinook salmon (<i>Oncorhynchus tshawytscha</i>)	N/A			N/A	N/A	N/A	
Atlantic salmon (<i>Salmo salar</i>)	N/A			N/A	N/A	N/A	
Brown Trout (<i>Salmo trutta</i>)	N/A			N/A	N/A	N/A	
Arctic char (<i>Salvelinus alpinus</i>)	N/A			N/A	N/A	N/A	
Southern Asian dolly varden (<i>Salvelinus curilus</i>)	N/A			N/A	N/A	N/A	
Brook trout (<i>Salvelinus fontinalis</i>)	N/A			N/A	N/A	N/A	
White-spotted char (<i>Salvelinus leucomaenis pluvius</i>)	N/A	N/A	N/A	N/A			

Chemical Name	CAS No.	Species	Parent Compound		Quinone		Citations
			Acute LC ₅₀ (Lowest Reported) (Flow Conditions, Exposure Measurement)	Duration of Exposure	Acute LC ₅₀ (Lowest Reported) (Flow Conditions, Exposure Measurement)	Duration of Exposure	
			µg/L	hr	µg/L	hr	
N-isopropyl-N'-phenyl-p-phenylenediamine (IPPD)	101-72-4	Pink salmon (<i>Oncorhynchus gorbuscha</i>), juvenile	N/A	N/A	N/A	N/A	
		Chum salmon (<i>Oncorhynchus keta</i>), juveniles	N/A	N/A	N/A	N/A	
		Coho salmon (<i>Oncorhynchus kisutch</i>), juvenile	N/A	N/A	N/A	N/A	
		Landlocked masu salmon (<i>Oncorhynchus masou masou</i>), juvenile	N/A	N/A	N/A	N/A	
		Rainbow trout (<i>Oncorhynchus mykiss</i>)	N/A	N/A	>50 (static, measured)	96	Nair et al., 2023
		Sockeye salmon (<i>Oncorhynchus nerka</i>)	N/A	N/A	N/A	N/A	
		Chinook salmon (<i>Oncorhynchus tshawytscha</i>)	N/A	N/A	N/A	N/A	
		Atlantic salmon (<i>Salmo salar</i>)	N/A	N/A	N/A	N/A	
		Brown Trout (<i>Salmo trutta</i>)	N/A	N/A	N/A	N/A	
		Arctic char (<i>Salvelinus alpinus</i>)	N/A	N/A	N/A	N/A	
		Southern Asian dolly varden (<i>Salvelinus curilus</i>)	N/A	N/A	N/A	N/A	
		Brook trout (<i>Salvelinus fontinalis</i>)	N/A	N/A	N/A	N/A	
White-spotted char (<i>Salvelinus leucomaenis pluvius</i>)	N/A	N/A	N/A	N/A			
N-cyclohexyl-N'-phenyl-p-phenylenediamine (CPPD)	101-87-1	Pink salmon (<i>Oncorhynchus gorbuscha</i>), juvenile	N/A	N/A	N/A	N/A	
		Chum salmon (<i>Oncorhynchus keta</i>), juveniles	N/A	N/A	N/A	N/A	
		Coho salmon (<i>Oncorhynchus kisutch</i>), juvenile	N/A	N/A	N/A	N/A	
		Landlocked masu salmon (<i>Oncorhynchus masou masou</i>), juvenile	N/A	N/A	N/A	N/A	
		Rainbow trout (<i>Oncorhynchus mykiss</i>)	N/A	N/A	>50 (static, measured)	96	Nair et al., 2023
		Sockeye salmon (<i>Oncorhynchus nerka</i>)	N/A	N/A	N/A	N/A	
		Chinook salmon (<i>Oncorhynchus tshawytscha</i>)	N/A	N/A	N/A	N/A	
		Atlantic salmon (<i>Salmo salar</i>)	N/A	N/A	N/A	N/A	
		Brown Trout (<i>Salmo trutta</i>)	N/A	N/A	N/A	N/A	
		Arctic char (<i>Salvelinus alpinus</i>)	N/A	N/A	N/A	N/A	
		Southern Asian dolly varden (<i>Salvelinus curilus</i>)	N/A	N/A	N/A	N/A	
		Brook trout (<i>Salvelinus fontinalis</i>)	N/A	N/A	N/A	N/A	
White-spotted char (<i>Salvelinus leucomaenis pluvius</i>)	N/A	N/A	N/A	N/A			
N,N'-diphenyl-p-phenylenediamine (DPPD)	74-31-7	Pink salmon (<i>Oncorhynchus gorbuscha</i>), juvenile	N/A	N/A	N/A	N/A	
		Chum salmon (<i>Oncorhynchus keta</i>), juveniles	N/A	N/A	N/A	N/A	
		Coho salmon (<i>Oncorhynchus kisutch</i>), juvenile	N/A	N/A	N/A	N/A	
		Landlocked masu salmon (<i>Oncorhynchus masou masou</i>), juvenile	N/A	N/A	N/A	N/A	
		Rainbow trout (<i>Oncorhynchus mykiss</i>)	N/A	N/A	>50 (static, measured)	96	Nair et al., 2023
		Sockeye salmon (<i>Oncorhynchus nerka</i>)	N/A	N/A	N/A	N/A	
		Chinook salmon (<i>Oncorhynchus tshawytscha</i>)	N/A	N/A	N/A	N/A	
		Atlantic salmon (<i>Salmo salar</i>)	N/A	N/A	N/A	N/A	
		Brown Trout (<i>Salmo trutta</i>)	N/A	N/A	N/A	N/A	
		Arctic char (<i>Salvelinus alpinus</i>)	N/A	N/A	N/A	N/A	
		Southern Asian dolly varden (<i>Salvelinus curilus</i>)	N/A	N/A	N/A	N/A	
		Brook trout (<i>Salvelinus fontinalis</i>)	N/A	N/A	N/A	N/A	
White-spotted char (<i>Salvelinus leucomaenis pluvius</i>)	N/A	N/A	N/A	N/A			

Chemical Name	CAS No.	Species	Parent Compound		Quinone		Citations
			Acute LC ₅₀ (Lowest Reported) (Flow Conditions, Exposure Measurement)	Duration of Exposure	Acute LC ₅₀ (Lowest Reported) (Flow Conditions, Exposure Measurement)	Duration of Exposure	
			µg/L	hr	µg/L	hr	
N-1,3-dimethyl butyl-N'-phenyl quinone diimine (6QDI)	52870-46-9	Pink salmon (<i>Oncorhynchus gorbuscha</i>), juvenile	N/A	N/A	N/A	N/A	
		Chum salmon (<i>Oncorhynchus keta</i>), juveniles	N/A	N/A	N/A	N/A	
		Coho salmon (<i>Oncorhynchus kisutch</i>), juvenile	N/A	N/A	N/A	N/A	
		Landlocked masu salmon (<i>Oncorhynchus masou masou</i>), juvenile	N/A	N/A	N/A	N/A	
		Rainbow trout (<i>Oncorhynchus mykiss</i>)	638 (semi-static, measurement not specified)	96	N/A	N/A	Flexsys, 2007, as cited in ECHA, 2024
		Sockeye salmon (<i>Oncorhynchus nerka</i>)	N/A	N/A	N/A	N/A	
		Chinook salmon (<i>Oncorhynchus tshawytscha</i>)	N/A	N/A	N/A	N/A	
		Atlantic salmon (<i>Salmo salar</i>)	N/A	N/A	N/A	N/A	
		Brown Trout (<i>Salmo trutta</i>)	N/A	N/A	N/A	N/A	
		Arctic char (<i>Salvelinus alpinus</i>)	N/A	N/A	N/A	N/A	
		Southern Asian dolly varden (<i>Salvelinus curilus</i>)	N/A	N/A	N/A	N/A	
		Brook trout (<i>Salvelinus fontinalis</i>)	N/A	N/A	N/A	N/A	
White-spotted char (<i>Salvelinus leucomaenis pluvius</i>)	N/A	N/A	N/A	N/A			
Polymerized 2,2,4-trimethyl-1,2-dihydroquinoline (TMQ)	26780-96-1	Pink salmon (<i>Oncorhynchus gorbuscha</i>), juvenile	N/A	N/A	N/A	N/A	
		Chum salmon (<i>Oncorhynchus keta</i>), juveniles	N/A	N/A	N/A	N/A	
		Coho salmon (<i>Oncorhynchus kisutch</i>), juvenile	N/A	N/A	N/A	N/A	
		Landlocked masu salmon (<i>Oncorhynchus masou masou</i>), juvenile	N/A	N/A	N/A	N/A	
		Rainbow trout (<i>Oncorhynchus mykiss</i>)	N/A	N/A	N/A	N/A	
		Sockeye salmon (<i>Oncorhynchus nerka</i>)	N/A	N/A	N/A	N/A	
		Chinook salmon (<i>Oncorhynchus tshawytscha</i>)	N/A	N/A	N/A	N/A	
		Atlantic salmon (<i>Salmo salar</i>)	N/A	N/A	N/A	N/A	
		Brown Trout (<i>Salmo trutta</i>)	N/A	N/A	N/A	N/A	
		Arctic char (<i>Salvelinus alpinus</i>)	N/A	N/A	N/A	N/A	
		Southern Asian dolly varden (<i>Salvelinus curilus</i>)	N/A	N/A	N/A	N/A	
		Brook trout (<i>Salvelinus fontinalis</i>)	N/A	N/A	N/A	N/A	
White-spotted char (<i>Salvelinus leucomaenis pluvius</i>)	N/A	N/A	N/A	N/A			
N,N'-Bis(1,4-dimethylpentyl)-p-phenylenediamine (77PD)	3081-14-9	Pink salmon (<i>Oncorhynchus gorbuscha</i>), juvenile	N/A	N/A	N/A	N/A	
		Chum salmon (<i>Oncorhynchus keta</i>), juveniles	N/A	N/A	N/A	N/A	
		Coho salmon (<i>Oncorhynchus kisutch</i>), juvenile	24 (flow-through, measured)	96	>226 (flow-through, measured)	96	Chapelet <i>et al.</i> , 2023
		Landlocked masu salmon (<i>Oncorhynchus masou masou</i>), juvenile	N/A	N/A	N/A	N/A	
		Rainbow trout (<i>Oncorhynchus mykiss</i>)	N/A	N/A	N/A	N/A	
		Sockeye salmon (<i>Oncorhynchus nerka</i>)	N/A	N/A	N/A	N/A	
		Chinook salmon (<i>Oncorhynchus tshawytscha</i>)	N/A	N/A	N/A	N/A	
		Atlantic salmon (<i>Salmo salar</i>)	N/A	N/A	N/A	N/A	
		Brown Trout (<i>Salmo trutta</i>)	N/A	N/A	N/A	N/A	
		Arctic char (<i>Salvelinus alpinus</i>)	N/A	N/A	N/A	N/A	
Southern Asian dolly varden (<i>Salvelinus curilus</i>)	N/A	N/A	N/A	N/A			
Brook trout (<i>Salvelinus fontinalis</i>)	N/A	N/A	N/A	N/A			
White-spotted char (<i>Salvelinus leucomaenis pluvius</i>)	N/A	N/A	N/A	N/A			

Chemical Name	CAS No.	Species	Parent Compound		Quinone		Citations
			Acute LC ₅₀ (Lowest Reported) (Flow Conditions, Exposure Measurement)	Duration of Exposure	Acute LC ₅₀ (Lowest Reported) (Flow Conditions, Exposure Measurement)	Duration of Exposure	
			µg/L	hr	µg/L	hr	
4,4'-Diocetyl-diphenylamine (DOPD)	101-67-7	Pink salmon (<i>Oncorhynchus gorbuscha</i>), juvenile	N/A	N/A	N/A	N/A	
		Chum salmon (<i>Oncorhynchus keta</i>), juveniles	N/A	N/A	N/A	N/A	
		Coho salmon (<i>Oncorhynchus kisutch</i>), juvenile	N/A	N/A	N/A	N/A	
		Landlocked masu salmon (<i>Oncorhynchus masou masou</i>), juvenile	N/A	N/A	N/A	N/A	
		Rainbow trout (<i>Oncorhynchus mykiss</i>)	N/A	N/A	N/A	N/A	
		Sockeye salmon (<i>Oncorhynchus nerka</i>)	N/A	N/A	N/A	N/A	
		Chinook salmon (<i>Oncorhynchus tshawytscha</i>)	N/A	N/A	N/A	N/A	
		Atlantic salmon (<i>Salmo salar</i>)	N/A	N/A	N/A	N/A	
		Brown Trout (<i>Salmo trutta</i>)	N/A	N/A	N/A	N/A	
		Arctic char (<i>Salvelinus alpinus</i>)	N/A	N/A	N/A	N/A	
		Southern Asian dolly varden (<i>Salvelinus curilus</i>)	N/A	N/A	N/A	N/A	
		Brook trout (<i>Salvelinus fontinalis</i>)	N/A	N/A	N/A	N/A	
White-spotted char (<i>Salvelinus leucomaenis pluvius</i>)	N/A	N/A	N/A	N/A			
N,N'-Ditolyl-p- phenylenediamine (Commercial DTPD)	68953-84-4	Pink salmon (<i>Oncorhynchus gorbuscha</i>), juvenile	N/A	N/A	N/A	N/A	
		Chum salmon (<i>Oncorhynchus keta</i>), juveniles	N/A	N/A	N/A	N/A	
		Coho salmon (<i>Oncorhynchus kisutch</i>), juvenile	N/A	N/A	N/A	N/A	
		Landlocked masu salmon (<i>Oncorhynchus masou masou</i>), juvenile	N/A	N/A	N/A	N/A	
		Rainbow trout (<i>Oncorhynchus mykiss</i>)	480 (flow-through, measured)	96	>50 (static, measured)	96	Unnamed study, 1997, as cited in ECHA, 2024; Nair <i>et al.</i> , 2023
		Sockeye salmon (<i>Oncorhynchus nerka</i>)	N/A	N/A	N/A	N/A	
		Chinook salmon (<i>Oncorhynchus tshawytscha</i>)	N/A	N/A	N/A	N/A	
		Atlantic salmon (<i>Salmo salar</i>)	N/A	N/A	N/A	N/A	
		Brown Trout (<i>Salmo trutta</i>)	N/A	N/A	N/A	N/A	
		Arctic char (<i>Salvelinus alpinus</i>)	N/A	N/A	N/A	N/A	
		Southern Asian dolly varden (<i>Salvelinus curilus</i>)	N/A	N/A	N/A	N/A	
		Brook trout (<i>Salvelinus fontinalis</i>)	N/A	N/A	N/A	N/A	
White-spotted char (<i>Salvelinus leucomaenis pluvius</i>)	N/A	N/A	N/A	N/A			

Chemical Name	CAS No.	Species	Parent Compound		Quinone		Citations
			Acute LC ₅₀ (Lowest Reported) (Flow Conditions, Exposure Measurement)	Duration of Exposure	Acute LC ₅₀ (Lowest Reported) (Flow Conditions, Exposure Measurement)	Duration of Exposure	
			µg/L	hr	µg/L	hr	
N,N'-Dicyclohexyl-p-phenylenediamine (CCPD)	4175-38-6	Pink salmon (<i>Oncorhynchus gorbuscha</i>), juvenile	N/A	N/A	N/A	N/A	
		Chum salmon (<i>Oncorhynchus keta</i>), juveniles	N/A	N/A	N/A	N/A	
		Coho salmon (<i>Oncorhynchus kisutch</i>), juvenile	N/A	N/A	N/A	N/A	
		Landlocked masu salmon (<i>Oncorhynchus masou masou</i>), juvenile	N/A	N/A	N/A	N/A	
		Rainbow trout (<i>Oncorhynchus mykiss</i>)	130 (based on surrogate 44PD) (static, nominal)	96	N/A	N/A	ToxServices, 2021
		Sockeye salmon (<i>Oncorhynchus nerka</i>)	N/A	N/A	N/A	N/A	
		Chinook salmon (<i>Oncorhynchus tshawytscha</i>)	N/A	N/A	N/A	N/A	
		Atlantic salmon (<i>Salmo salar</i>)	N/A	N/A	N/A	N/A	
		Brown Trout (<i>Salmo trutta</i>)	N/A	N/A	N/A	N/A	
		Arctic char (<i>Salvelinus alpinus</i>)	N/A	N/A	N/A	N/A	
		Southern Asian dolly varden (<i>Salvelinus curilus</i>)	N/A	N/A	N/A	N/A	
		Brook trout (<i>Salvelinus fontinalis</i>)	N/A	N/A	N/A	N/A	
White-spotted char (<i>Salvelinus leucomaenis pluvius</i>)	N/A	N/A	N/A	N/A			
Diaryl-p-phenylene diamine (DAPD is a class, main commercial DAPD is DTPD CASRN 68953-84-4)	68953-84-4	Pink salmon (<i>Oncorhynchus gorbuscha</i>), juvenile	N/A	N/A	N/A	N/A	
		Chum salmon (<i>Oncorhynchus keta</i>), juveniles	N/A	N/A	N/A	N/A	
		Coho salmon (<i>Oncorhynchus kisutch</i>), juvenile	N/A	N/A	N/A	N/A	
		Landlocked masu salmon (<i>Oncorhynchus masou masou</i>), juvenile	N/A	N/A	N/A	N/A	
		Rainbow trout (<i>Oncorhynchus mykiss</i>)	>480 (flow-through, measured)	96	N/A	N/A	Dionne, 1995, as cited in ECHA, 2024 (Weight of evidence 001)
		Sockeye salmon (<i>Oncorhynchus nerka</i>)	N/A	N/A	N/A	N/A	
		Chinook salmon (<i>Oncorhynchus tshawytscha</i>)	N/A	N/A	N/A	N/A	
		Atlantic salmon (<i>Salmo salar</i>)	N/A	N/A	N/A	N/A	
		Brown Trout (<i>Salmo trutta</i>)	N/A	N/A	N/A	N/A	
		Arctic char (<i>Salvelinus alpinus</i>)	N/A	N/A	N/A	N/A	
		Southern Asian dolly varden (<i>Salvelinus curilus</i>)	N/A	N/A	N/A	N/A	
		Brook trout (<i>Salvelinus fontinalis</i>)	N/A	N/A	N/A	N/A	
White-spotted char (<i>Salvelinus leucomaenis pluvius</i>)	N/A	N/A	N/A	N/A			
N,N'-Di-2-naphthyl-p-phenylenediamine (DNPDA)	93-46-9	Pink salmon (<i>Oncorhynchus gorbuscha</i>), juvenile	N/A	N/A	N/A	N/A	
		Chum salmon (<i>Oncorhynchus keta</i>), juveniles	N/A	N/A	N/A	N/A	
		Coho salmon (<i>Oncorhynchus kisutch</i>), juvenile	N/A	N/A	N/A	N/A	
		Landlocked masu salmon (<i>Oncorhynchus masou masou</i>), juvenile	N/A	N/A	N/A	N/A	
		Rainbow trout (<i>Oncorhynchus mykiss</i>)	N/A	N/A	N/A	N/A	
		Sockeye salmon (<i>Oncorhynchus nerka</i>)	N/A	N/A	N/A	N/A	
		Chinook salmon (<i>Oncorhynchus tshawytscha</i>)	N/A	N/A	N/A	N/A	
		Atlantic salmon (<i>Salmo salar</i>)	N/A	N/A	N/A	N/A	
		Brown Trout (<i>Salmo trutta</i>)	N/A	N/A	N/A	N/A	
		Arctic char (<i>Salvelinus alpinus</i>)	N/A	N/A	N/A	N/A	
		Southern Asian dolly varden (<i>Salvelinus curilus</i>)	N/A	N/A	N/A	N/A	
		Brook trout (<i>Salvelinus fontinalis</i>)	N/A	N/A	N/A	N/A	
White-spotted char (<i>Salvelinus leucomaenis pluvius</i>)	N/A	N/A	N/A	N/A			

Chemical Name	CAS No.	Species	Parent Compound		Quinone		Citations
			Acute LC ₅₀ (Lowest Reported) (Flow Conditions, Exposure Measurement)	Duration of Exposure	Acute LC ₅₀ (Lowest Reported) (Flow Conditions, Exposure Measurement)	Duration of Exposure	
			µg/L	hr	µg/L	hr	
Nickel dibutyldithiocarbamate (NBC)	13927-77-0	Pink salmon (<i>Oncorhynchus gorbuscha</i>), juvenile	N/A	N/A	N/A	N/A	
		Chum salmon (<i>Oncorhynchus keta</i>), juveniles	N/A	N/A	N/A	N/A	
		Coho salmon (<i>Oncorhynchus kisutch</i>), juvenile	N/A	N/A	N/A	N/A	
		Landlocked masu salmon (<i>Oncorhynchus masou masou</i>), juvenile	N/A	N/A	N/A	N/A	
		Rainbow trout (<i>Oncorhynchus mykiss</i>)	>100,000 (static, measurement not specified)	96	N/A	N/A	Mayer and Ellersieck, 1986
		Sockeye salmon (<i>Oncorhynchus nerka</i>)	N/A	N/A	N/A	N/A	
		Chinook salmon (<i>Oncorhynchus tshawytscha</i>)	N/A	N/A	N/A	N/A	
		Atlantic salmon (<i>Salmo salar</i>)	N/A	N/A	N/A	N/A	
		Brown Trout (<i>Salmo trutta</i>)	N/A	N/A	N/A	N/A	
		Arctic char (<i>Salvelinus alpinus</i>)	N/A	N/A	N/A	N/A	
		Southern Asian dolly varden (<i>Salvelinus curilus</i>)	N/A	N/A	N/A	N/A	
		Brook trout (<i>Salvelinus fontinalis</i>)	N/A	N/A	N/A	N/A	
		White-spotted char (<i>Salvelinus leucomaenis pluvius</i>)	N/A	N/A	N/A	N/A	
Ethoxyquin	91-53-2	Pink salmon (<i>Oncorhynchus gorbuscha</i>), juvenile	N/A	N/A	N/A	N/A	
		Chum salmon (<i>Oncorhynchus keta</i>), juveniles	N/A	N/A	N/A	N/A	
		Coho salmon (<i>Oncorhynchus kisutch</i>), juvenile	N/A	N/A	N/A	N/A	
		Landlocked masu salmon (<i>Oncorhynchus masou masou</i>), juvenile	N/A	N/A	N/A	N/A	
		Rainbow trout (<i>Oncorhynchus mykiss</i>)	18,000 (flow-through, measured)	96	N/A	N/A	Unnamed Study, 2007, as cited in ECHA, 2024
		Sockeye salmon (<i>Oncorhynchus nerka</i>)	N/A	N/A	N/A	N/A	
		Chinook salmon (<i>Oncorhynchus tshawytscha</i>)	N/A	N/A	N/A	N/A	
		Atlantic salmon (<i>Salmo salar</i>)	N/A	N/A	N/A	N/A	
		Brown Trout (<i>Salmo trutta</i>)	N/A	N/A	N/A	N/A	
		Arctic char (<i>Salvelinus alpinus</i>)	N/A	N/A	N/A	N/A	
		Southern Asian dolly varden (<i>Salvelinus curilus</i>)	N/A	N/A	N/A	N/A	
		Brook trout (<i>Salvelinus fontinalis</i>)	N/A	N/A	N/A	N/A	
		White-spotted char (<i>Salvelinus leucomaenis pluvius</i>)	N/A	N/A	N/A	N/A	
Dilauryl thiodipropionate	123-28-4	Pink salmon (<i>Oncorhynchus gorbuscha</i>), juvenile	N/A	N/A	N/A	N/A	
		Chum salmon (<i>Oncorhynchus keta</i>), juveniles	N/A	N/A	N/A	N/A	
		Coho salmon (<i>Oncorhynchus kisutch</i>), juvenile	N/A	N/A	N/A	N/A	
		Landlocked masu salmon (<i>Oncorhynchus masou masou</i>), juvenile	N/A	N/A	N/A	N/A	
		Rainbow trout (<i>Oncorhynchus mykiss</i>)	N/A	N/A	N/A	N/A	
		Sockeye salmon (<i>Oncorhynchus nerka</i>)	N/A	N/A	N/A	N/A	
		Chinook salmon (<i>Oncorhynchus tshawytscha</i>)	N/A	N/A	N/A	N/A	
		Atlantic salmon (<i>Salmo salar</i>)	N/A	N/A	N/A	N/A	
		Brown Trout (<i>Salmo trutta</i>)	N/A	N/A	N/A	N/A	
		Arctic char (<i>Salvelinus alpinus</i>)	N/A	N/A	N/A	N/A	
		Southern Asian dolly varden (<i>Salvelinus curilus</i>)	N/A	N/A	N/A	N/A	
		Brook trout (<i>Salvelinus fontinalis</i>)	N/A	N/A	N/A	N/A	
		White-spotted char (<i>Salvelinus leucomaenis pluvius</i>)	N/A	N/A	N/A	N/A	

Chemical Name	CAS No.	Species	Parent Compound		Quinone		Citations
			Acute LC ₅₀ (Lowest Reported) (Flow Conditions, Exposure Measurement)	Duration of Exposure	Acute LC ₅₀ (Lowest Reported) (Flow Conditions, Exposure Measurement)	Duration of Exposure	
			µg/L	hr	µg/L	hr	
N' -Phenyl.N-Fluorenyl- Para-Phenylenediamine	No CAS	Pink salmon (<i>Oncorhynchus gorbuscha</i>), juvenile	N/A	N/A	N/A	N/A	
		Chum salmon (<i>Oncorhynchus keta</i>), juveniles	N/A	N/A	N/A	N/A	
		Coho salmon (<i>Oncorhynchus kisutch</i>), juvenile	N/A	N/A	N/A	N/A	
		Landlocked masu salmon (<i>Oncorhynchus masou masou</i>), juvenile	N/A	N/A	N/A	N/A	
		Rainbow trout (<i>Oncorhynchus mykiss</i>)	N/A	N/A	N/A	N/A	
		Sockeye salmon (<i>Oncorhynchus nerka</i>)	N/A	N/A	N/A	N/A	
		Chinook salmon (<i>Oncorhynchus tshawytscha</i>)	N/A	N/A	N/A	N/A	
		Atlantic salmon (<i>Salmo salar</i>)	N/A	N/A	N/A	N/A	
		Brown Trout (<i>Salmo trutta</i>)	N/A	N/A	N/A	N/A	
		Arctic char (<i>Salvelinus alpinus</i>)	N/A	N/A	N/A	N/A	
		Southern Asian dolly varden (<i>Salvelinus curilus</i>)	N/A	N/A	N/A	N/A	
		Brook trout (<i>Salvelinus fontinalis</i>)	N/A	N/A	N/A	N/A	
White-spotted char (<i>Salvelinus leucomaenis pluvius</i>)	N/A	N/A	N/A	N/A			
N-(p- phenylthiomethylphenyl)- N'-(1,3 dimethyl-butyl)-p- phenylenediamine	No CAS	Pink salmon (<i>Oncorhynchus gorbuscha</i>), juvenile	N/A	N/A	N/A	N/A	
		Chum salmon (<i>Oncorhynchus keta</i>), juveniles	N/A	N/A	N/A	N/A	
		Coho salmon (<i>Oncorhynchus kisutch</i>), juvenile	N/A	N/A	N/A	N/A	
		Landlocked masu salmon (<i>Oncorhynchus masou masou</i>), juvenile	N/A	N/A	N/A	N/A	
		Rainbow trout (<i>Oncorhynchus mykiss</i>)	N/A	N/A	N/A	N/A	
		Sockeye salmon (<i>Oncorhynchus nerka</i>)	N/A	N/A	N/A	N/A	
		Chinook salmon (<i>Oncorhynchus tshawytscha</i>)	N/A	N/A	N/A	N/A	
		Atlantic salmon (<i>Salmo salar</i>)	N/A	N/A	N/A	N/A	
		Brown Trout (<i>Salmo trutta</i>)	N/A	N/A	N/A	N/A	
		Arctic char (<i>Salvelinus alpinus</i>)	N/A	N/A	N/A	N/A	
		Southern Asian dolly varden (<i>Salvelinus curilus</i>)	N/A	N/A	N/A	N/A	
		Brook trout (<i>Salvelinus fontinalis</i>)	N/A	N/A	N/A	N/A	
White-spotted char (<i>Salvelinus leucomaenis pluvius</i>)	N/A	N/A	N/A	N/A			
4-(2,5-dimethyl-1H-pyrrol- 1-yl)-N-phenylaniline	No CAS	Pink salmon (<i>Oncorhynchus gorbuscha</i>), juvenile	N/A	N/A	N/A	N/A	
		Chum salmon (<i>Oncorhynchus keta</i>), juveniles	N/A	N/A	N/A	N/A	
		Coho salmon (<i>Oncorhynchus kisutch</i>), juvenile	N/A	N/A	N/A	N/A	
		Landlocked masu salmon (<i>Oncorhynchus masou masou</i>), juvenile	N/A	N/A	N/A	N/A	
		Rainbow trout (<i>Oncorhynchus mykiss</i>)	N/A	N/A	N/A	N/A	
		Sockeye salmon (<i>Oncorhynchus nerka</i>)	N/A	N/A	N/A	N/A	
		Chinook salmon (<i>Oncorhynchus tshawytscha</i>)	N/A	N/A	N/A	N/A	
		Atlantic salmon (<i>Salmo salar</i>)	N/A	N/A	N/A	N/A	
		Brown Trout (<i>Salmo trutta</i>)	N/A	N/A	N/A	N/A	
		Arctic char (<i>Salvelinus alpinus</i>)	N/A	N/A	N/A	N/A	
		Southern Asian dolly varden (<i>Salvelinus curilus</i>)	N/A	N/A	N/A	N/A	
		Brook trout (<i>Salvelinus fontinalis</i>)	N/A	N/A	N/A	N/A	
White-spotted char (<i>Salvelinus leucomaenis pluvius</i>)	N/A	N/A	N/A	N/A			

Chemical Name	CAS No.	Species	Parent Compound		Quinone		Citations
			Acute LC ₅₀ (Lowest Reported) (Flow Conditions, Exposure Measurement)	Duration of Exposure	Acute LC ₅₀ (Lowest Reported) (Flow Conditions, Exposure Measurement)	Duration of Exposure	
			µg/L	hr	µg/L	hr	
N,N - (ethane-1,2-diyl) bis (N-phenylbenzene-1 4- diamine [example chemical from patent])	No CAS	Pink salmon (<i>Oncorhynchus gorbuscha</i>), juvenile	N/A	N/A	N/A	N/A	
		Chum salmon (<i>Oncorhynchus keta</i>), juveniles	N/A	N/A	N/A	N/A	
		Coho salmon (<i>Oncorhynchus kisutch</i>), juvenile	N/A	N/A	N/A	N/A	
		Landlocked masu salmon (<i>Oncorhynchus masou masou</i>), juvenile	N/A	N/A	N/A	N/A	
		Rainbow trout (<i>Oncorhynchus mykiss</i>)	N/A	N/A	N/A	N/A	
		Sockeye salmon (<i>Oncorhynchus nerka</i>)	N/A	N/A	N/A	N/A	
		Chinook salmon (<i>Oncorhynchus tshawytscha</i>)	N/A	N/A	N/A	N/A	
		Atlantic salmon (<i>Salmo salar</i>)	N/A	N/A	N/A	N/A	
		Brown Trout (<i>Salmo trutta</i>)	N/A	N/A	N/A	N/A	
		Arctic char (<i>Salvelinus alpinus</i>)	N/A	N/A	N/A	N/A	
		Southern Asian dolly varden (<i>Salvelinus curilus</i>)	N/A	N/A	N/A	N/A	
		Brook trout (<i>Salvelinus fontinalis</i>)	N/A	N/A	N/A	N/A	
White-spotted char (<i>Salvelinus leucomaenis pluvius</i>)	N/A	N/A	N/A	N/A			
4-N-(2,3-dimethylphenyl)-1- N-phenylbenzene-1,4- diamine- R1 and R2 are methyl	No CAS	Pink salmon (<i>Oncorhynchus gorbuscha</i>), juvenile	N/A	N/A	N/A	N/A	
		Chum salmon (<i>Oncorhynchus keta</i>), juveniles	N/A	N/A	N/A	N/A	
		Coho salmon (<i>Oncorhynchus kisutch</i>), juvenile	N/A	N/A	N/A	N/A	
		Landlocked masu salmon (<i>Oncorhynchus masou masou</i>), juvenile	N/A	N/A	N/A	N/A	
		Rainbow trout (<i>Oncorhynchus mykiss</i>)	N/A	N/A	N/A	N/A	
		Sockeye salmon (<i>Oncorhynchus nerka</i>)	N/A	N/A	N/A	N/A	
		Chinook salmon (<i>Oncorhynchus tshawytscha</i>)	N/A	N/A	N/A	N/A	
		Atlantic salmon (<i>Salmo salar</i>)	N/A	N/A	N/A	N/A	
		Brown Trout (<i>Salmo trutta</i>)	N/A	N/A	N/A	N/A	
		Arctic char (<i>Salvelinus alpinus</i>)	N/A	N/A	N/A	N/A	
		Southern Asian dolly varden (<i>Salvelinus curilus</i>)	N/A	N/A	N/A	N/A	
		Brook trout (<i>Salvelinus fontinalis</i>)	N/A	N/A	N/A	N/A	
White-spotted char (<i>Salvelinus leucomaenis pluvius</i>)	N/A	N/A	N/A	N/A			
RU997, Irgazone 997 (Reaction product of N- phenyl-N'- (1,3dimethylbutyl)-p- phenylenediamine with an alkyl glycidylthioether)	444992-04-5	Pink salmon (<i>Oncorhynchus gorbuscha</i>), juvenile	N/A	N/A	N/A	N/A	
		Chum salmon (<i>Oncorhynchus keta</i>), juveniles	N/A	N/A	N/A	N/A	
		Coho salmon (<i>Oncorhynchus kisutch</i>), juvenile	N/A	N/A	N/A	N/A	
		Landlocked masu salmon (<i>Oncorhynchus masou masou</i>), juvenile	N/A	N/A	N/A	N/A	
		Rainbow trout (<i>Oncorhynchus mykiss</i>)	N/A	N/A	N/A	N/A	
		Sockeye salmon (<i>Oncorhynchus nerka</i>)	N/A	N/A	N/A	N/A	
		Chinook salmon (<i>Oncorhynchus tshawytscha</i>)	N/A	N/A	N/A	N/A	
		Atlantic salmon (<i>Salmo salar</i>)	N/A	N/A	N/A	N/A	
		Brown Trout (<i>Salmo trutta</i>)	N/A	N/A	N/A	N/A	
		Arctic char (<i>Salvelinus alpinus</i>)	N/A	N/A	N/A	N/A	
		Southern Asian dolly varden (<i>Salvelinus curilus</i>)	N/A	N/A	N/A	N/A	
		Brook trout (<i>Salvelinus fontinalis</i>)	N/A	N/A	N/A	N/A	
White-spotted char (<i>Salvelinus leucomaenis pluvius</i>)	N/A	N/A	N/A	N/A			

Chemical Name	CAS No.	Species	Parent Compound		Quinone		Citations
			Acute LC ₅₀ (Lowest Reported) (Flow Conditions, Exposure Measurement)	Duration of Exposure	Acute LC ₅₀ (Lowest Reported) (Flow Conditions, Exposure Measurement)	Duration of Exposure	
			µg/L	hr	µg/L	hr	
4-[4-(4-Methylpentan-2-ylamino)anilino]phenol	No CAS	Pink salmon (<i>Oncorhynchus gorbuscha</i>), juvenile	N/A	N/A	N/A	N/A	
		Chum salmon (<i>Oncorhynchus keta</i>), juveniles	N/A	N/A	N/A	N/A	
		Coho salmon (<i>Oncorhynchus kisutch</i>), juvenile	N/A	N/A	N/A	N/A	
		Landlocked masu salmon (<i>Oncorhynchus masou masou</i>), juvenile	N/A	N/A	N/A	N/A	
		Rainbow trout (<i>Oncorhynchus mykiss</i>)	N/A	N/A	N/A	N/A	
		Sockeye salmon (<i>Oncorhynchus nerka</i>)	N/A	N/A	N/A	N/A	
		Chinook salmon (<i>Oncorhynchus tshawytscha</i>)	N/A	N/A	N/A	N/A	
		Atlantic salmon (<i>Salmo salar</i>)	N/A	N/A	N/A	N/A	
		Brown Trout (<i>Salmo trutta</i>)	N/A	N/A	N/A	N/A	
		Arctic char (<i>Salvelinus alpinus</i>)	N/A	N/A	N/A	N/A	
		Southern Asian dolly varden (<i>Salvelinus curilus</i>)	N/A	N/A	N/A	N/A	
		Brook trout (<i>Salvelinus fontinalis</i>)	N/A	N/A	N/A	N/A	
White-spotted char (<i>Salvelinus leucomaenis pluvius</i>)	N/A	N/A	N/A	N/A			
Representative example from class 4-((4-(dimethylamino)phenyl)amino)phenol	6358-22-1	Pink salmon (<i>Oncorhynchus gorbuscha</i>), juvenile	N/A	N/A	N/A	N/A	
		Chum salmon (<i>Oncorhynchus keta</i>), juveniles	N/A	N/A	N/A	N/A	
		Coho salmon (<i>Oncorhynchus kisutch</i>), juvenile	N/A	N/A	N/A	N/A	
		Landlocked masu salmon (<i>Oncorhynchus masou masou</i>), juvenile	N/A	N/A	N/A	N/A	
		Rainbow trout (<i>Oncorhynchus mykiss</i>)	N/A	N/A	N/A	N/A	
		Sockeye salmon (<i>Oncorhynchus nerka</i>)	N/A	N/A	N/A	N/A	
		Chinook salmon (<i>Oncorhynchus tshawytscha</i>)	N/A	N/A	N/A	N/A	
		Atlantic salmon (<i>Salmo salar</i>)	N/A	N/A	N/A	N/A	
		Brown Trout (<i>Salmo trutta</i>)	N/A	N/A	N/A	N/A	
		Arctic char (<i>Salvelinus alpinus</i>)	N/A	N/A	N/A	N/A	
		Southern Asian dolly varden (<i>Salvelinus curilus</i>)	N/A	N/A	N/A	N/A	
		Brook trout (<i>Salvelinus fontinalis</i>)	N/A	N/A	N/A	N/A	
White-spotted char (<i>Salvelinus leucomaenis pluvius</i>)	N/A	N/A	N/A	N/A			
N,N-diethyl-2,2,4-trimethyl-1H-quinolin-6-amine (R=N(C2H5)2)	No CAS	Pink salmon (<i>Oncorhynchus gorbuscha</i>), juvenile	N/A	N/A	N/A	N/A	
		Chum salmon (<i>Oncorhynchus keta</i>), juveniles	N/A	N/A	N/A	N/A	
		Coho salmon (<i>Oncorhynchus kisutch</i>), juvenile	N/A	N/A	N/A	N/A	
		Landlocked masu salmon (<i>Oncorhynchus masou masou</i>), juvenile	N/A	N/A	N/A	N/A	
		Rainbow trout (<i>Oncorhynchus mykiss</i>)	N/A	N/A	N/A	N/A	
		Sockeye salmon (<i>Oncorhynchus nerka</i>)	N/A	N/A	N/A	N/A	
		Chinook salmon (<i>Oncorhynchus tshawytscha</i>)	N/A	N/A	N/A	N/A	
		Atlantic salmon (<i>Salmo salar</i>)	N/A	N/A	N/A	N/A	
		Brown Trout (<i>Salmo trutta</i>)	N/A	N/A	N/A	N/A	
		Arctic char (<i>Salvelinus alpinus</i>)	N/A	N/A	N/A	N/A	
		Southern Asian dolly varden (<i>Salvelinus curilus</i>)	N/A	N/A	N/A	N/A	
		Brook trout (<i>Salvelinus fontinalis</i>)	N/A	N/A	N/A	N/A	
White-spotted char (<i>Salvelinus leucomaenis pluvius</i>)	N/A	N/A	N/A	N/A			

Chemical Name	CAS No.	Species	Parent Compound		Quinone		Citations
			Acute LC ₅₀ (Lowest Reported) (Flow Conditions, Exposure Measurement)	Duration of Exposure	Acute LC ₅₀ (Lowest Reported) (Flow Conditions, Exposure Measurement)	Duration of Exposure	
			µg/L	hr	µg/L	hr	
N,N'-Dibenzyl-p-xylene-alpha,alpha'-diamine-	25790-41-4	Pink salmon (<i>Oncorhynchus gorbuscha</i>), juvenile	N/A	N/A	N/A	N/A	
		Chum salmon (<i>Oncorhynchus keta</i>), juveniles	N/A	N/A	N/A	N/A	
		Coho salmon (<i>Oncorhynchus kisutch</i>), juvenile	N/A	N/A	N/A	N/A	
		Landlocked masu salmon (<i>Oncorhynchus masou masou</i>), juvenile	N/A	N/A	N/A	N/A	
		Rainbow trout (<i>Oncorhynchus mykiss</i>)	N/A	N/A	N/A	N/A	
		Sockeye salmon (<i>Oncorhynchus nerka</i>)	N/A	N/A	N/A	N/A	
		Chinook salmon (<i>Oncorhynchus tshawytscha</i>)	N/A	N/A	N/A	N/A	
		Atlantic salmon (<i>Salmo salar</i>)	N/A	N/A	N/A	N/A	
		Brown Trout (<i>Salmo trutta</i>)	N/A	N/A	N/A	N/A	
		Arctic char (<i>Salvelinus alpinus</i>)	N/A	N/A	N/A	N/A	
		Southern Asian dolly varden (<i>Salvelinus curilus</i>)	N/A	N/A	N/A	N/A	
		Brook trout (<i>Salvelinus fontinalis</i>)	N/A	N/A	N/A	N/A	
White-spotted char (<i>Salvelinus leucomaenis pluvius</i>)	N/A	N/A	N/A	N/A			
2,4,6-tris-(N-1,4-dimethylpentyl-para-phenylenediamino)-1,3,5-triazine (Durazone 37 or TAPDT)	121246-28-4	Pink salmon (<i>Oncorhynchus gorbuscha</i>), juvenile	N/A	N/A	N/A	N/A	
		Chum salmon (<i>Oncorhynchus keta</i>), juveniles	N/A	N/A	N/A	N/A	
		Coho salmon (<i>Oncorhynchus kisutch</i>), juvenile	N/A	N/A	N/A	N/A	
		Landlocked masu salmon (<i>Oncorhynchus masou masou</i>), juvenile	N/A	N/A	N/A	N/A	
		Rainbow trout (<i>Oncorhynchus mykiss</i>)	N/A	N/A	N/A	N/A	
		Sockeye salmon (<i>Oncorhynchus nerka</i>)	N/A	N/A	N/A	N/A	
		Chinook salmon (<i>Oncorhynchus tshawytscha</i>)	N/A	N/A	N/A	N/A	
		Atlantic salmon (<i>Salmo salar</i>)	N/A	N/A	N/A	N/A	
		Brown Trout (<i>Salmo trutta</i>)	N/A	N/A	N/A	N/A	
		Arctic char (<i>Salvelinus alpinus</i>)	N/A	N/A	N/A	N/A	
		Southern Asian dolly varden (<i>Salvelinus curilus</i>)	N/A	N/A	N/A	N/A	
		Brook trout (<i>Salvelinus fontinalis</i>)	N/A	N/A	N/A	N/A	
White-spotted char (<i>Salvelinus leucomaenis pluvius</i>)	N/A	N/A	N/A	N/A			
N-Phenyl-1-naphthylamine	90-30-2	Pink salmon (<i>Oncorhynchus gorbuscha</i>), juvenile	N/A	N/A	N/A	N/A	
		Chum salmon (<i>Oncorhynchus keta</i>), juveniles	N/A	N/A	N/A	N/A	
		Coho salmon (<i>Oncorhynchus kisutch</i>), juvenile	N/A	N/A	N/A	N/A	
		Landlocked masu salmon (<i>Oncorhynchus masou masou</i>), juvenile	N/A	N/A	N/A	N/A	
		Rainbow trout (<i>Oncorhynchus mykiss</i>)	440 (semi-static, nominal)	96	N/A	N/A	Unnamed Study, 1981, as cited in ECHA, 2024
		Sockeye salmon (<i>Oncorhynchus nerka</i>)	N/A	N/A	N/A	N/A	
		Chinook salmon (<i>Oncorhynchus tshawytscha</i>)	N/A	N/A	N/A	N/A	
		Atlantic salmon (<i>Salmo salar</i>)	N/A	N/A	N/A	N/A	
		Brown Trout (<i>Salmo trutta</i>)	N/A	N/A	N/A	N/A	
		Arctic char (<i>Salvelinus alpinus</i>)	N/A	N/A	N/A	N/A	
		Southern Asian dolly varden (<i>Salvelinus curilus</i>)	N/A	N/A	N/A	N/A	
		Brook trout (<i>Salvelinus fontinalis</i>)	N/A	N/A	N/A	N/A	
White-spotted char (<i>Salvelinus leucomaenis pluvius</i>)	N/A	N/A	N/A	N/A			

Chemical Name	CAS No.	Species	Parent Compound		Quinone		Citations
			Acute LC ₅₀ (Lowest Reported) (Flow Conditions, Exposure Measurement)	Duration of Exposure	Acute LC ₅₀ (Lowest Reported) (Flow Conditions, Exposure Measurement)	Duration of Exposure	
			µg/L	hr	µg/L	hr	
N-Phenyl-2-naphthylamine	135-88-6	Pink salmon (<i>Oncorhynchus gorbuscha</i>), juvenile	N/A	N/A	N/A	N/A	
		Chum salmon (<i>Oncorhynchus keta</i>), juveniles	N/A	N/A	N/A	N/A	
		Coho salmon (<i>Oncorhynchus kisutch</i>), juvenile	N/A	N/A	N/A	N/A	
		Landlocked masu salmon (<i>Oncorhynchus masou masou</i>), juvenile	N/A	N/A	N/A	N/A	
		Rainbow trout (<i>Oncorhynchus mykiss</i>)	N/A	N/A	N/A	N/A	
		Sockeye salmon (<i>Oncorhynchus nerka</i>)	N/A	N/A	N/A	N/A	
		Chinook salmon (<i>Oncorhynchus tshawytscha</i>)	N/A	N/A	N/A	N/A	
		Atlantic salmon (<i>Salmo salar</i>)	N/A	N/A	N/A	N/A	
		Brown Trout (<i>Salmo trutta</i>)	N/A	N/A	N/A	N/A	
		Arctic char (<i>Salvelinus alpinus</i>)	N/A	N/A	N/A	N/A	
		Southern Asian dolly varden (<i>Salvelinus curilus</i>)	N/A	N/A	N/A	N/A	
		Brook trout (<i>Salvelinus fontinalis</i>)	N/A	N/A	N/A	N/A	
White-spotted char (<i>Salvelinus leucomaenis pluvius</i>)	N/A	N/A	N/A	N/A			
[2-Methyl-4,6-bis((octylthio)methyl)phenol (Irganox 1520)	110553-27-0	Pink salmon (<i>Oncorhynchus gorbuscha</i>), juvenile	N/A	N/A	N/A	N/A	
		Chum salmon (<i>Oncorhynchus keta</i>), juveniles	N/A	N/A	N/A	N/A	
		Coho salmon (<i>Oncorhynchus kisutch</i>), juvenile	N/A	N/A	N/A	N/A	
		Landlocked masu salmon (<i>Oncorhynchus masou masou</i>), juvenile	N/A	N/A	N/A	N/A	
		Rainbow trout (<i>Oncorhynchus mykiss</i>)	N/A	N/A	N/A	N/A	
		Sockeye salmon (<i>Oncorhynchus nerka</i>)	N/A	N/A	N/A	N/A	
		Chinook salmon (<i>Oncorhynchus tshawytscha</i>)	N/A	N/A	N/A	N/A	
		Atlantic salmon (<i>Salmo salar</i>)	N/A	N/A	N/A	N/A	
		Brown Trout (<i>Salmo trutta</i>)	N/A	N/A	N/A	N/A	
		Arctic char (<i>Salvelinus alpinus</i>)	N/A	N/A	N/A	N/A	
		Southern Asian dolly varden (<i>Salvelinus curilus</i>)	N/A	N/A	N/A	N/A	
		Brook trout (<i>Salvelinus fontinalis</i>)	N/A	N/A	N/A	N/A	
White-spotted char (<i>Salvelinus leucomaenis pluvius</i>)	N/A	N/A	N/A	N/A			
Graphene	1034343-98-0	Pink salmon (<i>Oncorhynchus gorbuscha</i>), juvenile	N/A	N/A	N/A	N/A	
		Chum salmon (<i>Oncorhynchus keta</i>), juveniles	N/A	N/A	N/A	N/A	
		Coho salmon (<i>Oncorhynchus kisutch</i>), juvenile	N/A	N/A	N/A	N/A	
		Landlocked masu salmon (<i>Oncorhynchus masou masou</i>), juvenile	N/A	N/A	N/A	N/A	
		Rainbow trout (<i>Oncorhynchus mykiss</i>)	N/A	N/A	N/A	N/A	
		Sockeye salmon (<i>Oncorhynchus nerka</i>)	N/A	N/A	N/A	N/A	
		Chinook salmon (<i>Oncorhynchus tshawytscha</i>)	N/A	N/A	N/A	N/A	
		Atlantic salmon (<i>Salmo salar</i>)	N/A	N/A	N/A	N/A	
		Brown Trout (<i>Salmo trutta</i>)	N/A	N/A	N/A	N/A	
		Arctic char (<i>Salvelinus alpinus</i>)	N/A	N/A	N/A	N/A	
		Southern Asian dolly varden (<i>Salvelinus curilus</i>)	N/A	N/A	N/A	N/A	
		Brook trout (<i>Salvelinus fontinalis</i>)	N/A	N/A	N/A	N/A	
White-spotted char (<i>Salvelinus leucomaenis pluvius</i>)	N/A	N/A	N/A	N/A			

Chemical Name	CAS No.	Species	Parent Compound		Quinone		Citations
			Acute LC ₅₀ (Lowest Reported) (Flow Conditions, Exposure Measurement)	Duration of Exposure	Acute LC ₅₀ (Lowest Reported) (Flow Conditions, Exposure Measurement)	Duration of Exposure	
			µg/L	hr	µg/L	hr	
1,1' - Pentamethylenebis(2,2-Di- n- Butylhydrazine)	No CAS	Pink salmon (<i>Oncorhynchus gorbuscha</i>), juvenile	N/A	N/A	N/A	N/A	
		Chum salmon (<i>Oncorhynchus keta</i>), juveniles	N/A	N/A	N/A	N/A	
		Coho salmon (<i>Oncorhynchus kisutch</i>), juvenile	N/A	N/A	N/A	N/A	
		Landlocked masu salmon (<i>Oncorhynchus masou masou</i>), juvenile	N/A	N/A	N/A	N/A	
		Rainbow trout (<i>Oncorhynchus mykiss</i>)	N/A	N/A	N/A	N/A	
		Sockeye salmon (<i>Oncorhynchus nerka</i>)	N/A	N/A	N/A	N/A	
		Chinook salmon (<i>Oncorhynchus tshawytscha</i>)	N/A	N/A	N/A	N/A	
		Atlantic salmon (<i>Salmo salar</i>)	N/A	N/A	N/A	N/A	
		Brown Trout (<i>Salmo trutta</i>)	N/A	N/A	N/A	N/A	
		Arctic char (<i>Salvelinus alpinus</i>)	N/A	N/A	N/A	N/A	
		Southern Asian dolly varden (<i>Salvelinus curilus</i>)	N/A	N/A	N/A	N/A	
		Brook trout (<i>Salvelinus fontinalis</i>)	N/A	N/A	N/A	N/A	
White-spotted char (<i>Salvelinus leucomaenis pluvius</i>)	N/A	N/A	N/A	N/A			
α- C-4- hydroxy- 3,5- dimethylphenyl - N-isopropyl and Lowinox WSP	Nitron as a class, no CAS and Lowinox WSP - 77-62-3	Pink salmon (<i>Oncorhynchus gorbuscha</i>), juvenile	N/A	N/A	N/A	N/A	
		Chum salmon (<i>Oncorhynchus keta</i>), juveniles	N/A	N/A	N/A	N/A	
		Coho salmon (<i>Oncorhynchus kisutch</i>), juvenile	N/A	N/A	N/A	N/A	
		Landlocked masu salmon (<i>Oncorhynchus masou masou</i>), juvenile	N/A	N/A	N/A	N/A	
		Rainbow trout (<i>Oncorhynchus mykiss</i>)	N/A	N/A	N/A	N/A	
		Sockeye salmon (<i>Oncorhynchus nerka</i>)	N/A	N/A	N/A	N/A	
		Chinook salmon (<i>Oncorhynchus tshawytscha</i>)	N/A	N/A	N/A	N/A	
		Atlantic salmon (<i>Salmo salar</i>)	N/A	N/A	N/A	N/A	
		Brown Trout (<i>Salmo trutta</i>)	N/A	N/A	N/A	N/A	
		Arctic char (<i>Salvelinus alpinus</i>)	N/A	N/A	N/A	N/A	
		Southern Asian dolly varden (<i>Salvelinus curilus</i>)	N/A	N/A	N/A	N/A	
		Brook trout (<i>Salvelinus fontinalis</i>)	N/A	N/A	N/A	N/A	
White-spotted char (<i>Salvelinus leucomaenis pluvius</i>)	N/A	N/A	N/A	N/A			
N-(4-methylpentan-2-yl)- 10H-phenothiazin-3-amine	No CAS	Pink salmon (<i>Oncorhynchus gorbuscha</i>), juvenile	N/A	N/A	N/A	N/A	
		Chum salmon (<i>Oncorhynchus keta</i>), juveniles	N/A	N/A	N/A	N/A	
		Coho salmon (<i>Oncorhynchus kisutch</i>), juvenile	N/A	N/A	N/A	N/A	
		Landlocked masu salmon (<i>Oncorhynchus masou masou</i>), juvenile	N/A	N/A	N/A	N/A	
		Rainbow trout (<i>Oncorhynchus mykiss</i>)	N/A	N/A	N/A	N/A	
		Sockeye salmon (<i>Oncorhynchus nerka</i>)	N/A	N/A	N/A	N/A	
		Chinook salmon (<i>Oncorhynchus tshawytscha</i>)	N/A	N/A	N/A	N/A	
		Atlantic salmon (<i>Salmo salar</i>)	N/A	N/A	N/A	N/A	
		Brown Trout (<i>Salmo trutta</i>)	N/A	N/A	N/A	N/A	
		Arctic char (<i>Salvelinus alpinus</i>)	N/A	N/A	N/A	N/A	
		Southern Asian dolly varden (<i>Salvelinus curilus</i>)	N/A	N/A	N/A	N/A	
		Brook trout (<i>Salvelinus fontinalis</i>)	N/A	N/A	N/A	N/A	
White-spotted char (<i>Salvelinus leucomaenis pluvius</i>)	N/A	N/A	N/A	N/A			

Chemical Name	CAS No.	Species	Parent Compound		Quinone		Citations
			Acute LC ₅₀ (Lowest Reported) (Flow Conditions, Exposure Measurement)	Duration of Exposure	Acute LC ₅₀ (Lowest Reported) (Flow Conditions, Exposure Measurement)	Duration of Exposure	
			µg/L	hr	µg/L	hr	
7-(4-methylpentan-2-ylamino)-2,3,4,10-tetrahydro-1H-acridin-9-one	No CAS	Pink salmon (<i>Oncorhynchus gorbuscha</i>), juvenile	N/A	N/A	N/A	N/A	
		Chum salmon (<i>Oncorhynchus keta</i>), juveniles	N/A	N/A	N/A	N/A	
		Coho salmon (<i>Oncorhynchus kisutch</i>), juvenile	N/A	N/A	N/A	N/A	
		Landlocked masu salmon (<i>Oncorhynchus masou masou</i>), juvenile	N/A	N/A	N/A	N/A	
		Rainbow trout (<i>Oncorhynchus mykiss</i>)	N/A	N/A	N/A	N/A	
		Sockeye salmon (<i>Oncorhynchus nerka</i>)	N/A	N/A	N/A	N/A	
		Chinook salmon (<i>Oncorhynchus tshawytscha</i>)	N/A	N/A	N/A	N/A	
		Atlantic salmon (<i>Salmo salar</i>)	N/A	N/A	N/A	N/A	
		Brown Trout (<i>Salmo trutta</i>)	N/A	N/A	N/A	N/A	
		Arctic char (<i>Salvelinus alpinus</i>)	N/A	N/A	N/A	N/A	
		Southern Asian dolly varden (<i>Salvelinus curilus</i>)	N/A	N/A	N/A	N/A	
		Brook trout (<i>Salvelinus fontinalis</i>)	N/A	N/A	N/A	N/A	
White-spotted char (<i>Salvelinus leucomaenis pluvius</i>)	N/A	N/A	N/A	N/A			
2-cyclohexyl-N-(4-methylpentan-2-yl)-1H-indol-5-amine	No CAS	Pink salmon (<i>Oncorhynchus gorbuscha</i>), juvenile	N/A	N/A	N/A	N/A	
		Chum salmon (<i>Oncorhynchus keta</i>), juveniles	N/A	N/A	N/A	N/A	
		Coho salmon (<i>Oncorhynchus kisutch</i>), juvenile	N/A	N/A	N/A	N/A	
		Landlocked masu salmon (<i>Oncorhynchus masou masou</i>), juvenile	N/A	N/A	N/A	N/A	
		Rainbow trout (<i>Oncorhynchus mykiss</i>)	N/A	N/A	N/A	N/A	
		Sockeye salmon (<i>Oncorhynchus nerka</i>)	N/A	N/A	N/A	N/A	
		Chinook salmon (<i>Oncorhynchus tshawytscha</i>)	N/A	N/A	N/A	N/A	
		Atlantic salmon (<i>Salmo salar</i>)	N/A	N/A	N/A	N/A	
		Brown Trout (<i>Salmo trutta</i>)	N/A	N/A	N/A	N/A	
		Arctic char (<i>Salvelinus alpinus</i>)	N/A	N/A	N/A	N/A	
		Southern Asian dolly varden (<i>Salvelinus curilus</i>)	N/A	N/A	N/A	N/A	
		Brook trout (<i>Salvelinus fontinalis</i>)	N/A	N/A	N/A	N/A	
White-spotted char (<i>Salvelinus leucomaenis pluvius</i>)	N/A	N/A	N/A	N/A			
4-(1H-indol-2-yl)-N-(4-methylpentan-2-yl)aniline	No CAS	Pink salmon (<i>Oncorhynchus gorbuscha</i>), juvenile	N/A	N/A	N/A	N/A	
		Chum salmon (<i>Oncorhynchus keta</i>), juveniles	N/A	N/A	N/A	N/A	
		Coho salmon (<i>Oncorhynchus kisutch</i>), juvenile	N/A	N/A	N/A	N/A	
		Landlocked masu salmon (<i>Oncorhynchus masou masou</i>), juvenile	N/A	N/A	N/A	N/A	
		Rainbow trout (<i>Oncorhynchus mykiss</i>)	N/A	N/A	N/A	N/A	
		Sockeye salmon (<i>Oncorhynchus nerka</i>)	N/A	N/A	N/A	N/A	
		Chinook salmon (<i>Oncorhynchus tshawytscha</i>)	N/A	N/A	N/A	N/A	
		Atlantic salmon (<i>Salmo salar</i>)	N/A	N/A	N/A	N/A	
		Arctic char (<i>Salvelinus alpinus</i>)	N/A	N/A	N/A	N/A	
		Southern Asian dolly varden (<i>Salvelinus curilus</i>)	N/A	N/A	N/A	N/A	
		Brook trout (<i>Salvelinus fontinalis</i>)	N/A	N/A	N/A	N/A	
		White-spotted char (<i>Salvelinus leucomaenis pluvius</i>)	N/A	N/A	N/A	N/A	

Chemical Name	CAS No.	Species	Parent Compound		Quinone		Citations
			Acute LC ₅₀ (Lowest Reported) (Flow Conditions, Exposure Measurement)	Duration of Exposure	Acute LC ₅₀ (Lowest Reported) (Flow Conditions, Exposure Measurement)	Duration of Exposure	
			µg/L	hr	µg/L	hr	
α- C-4- Hydroxy- 3,5- dimethylphenyl- N-tert. butyl nitrone	No CAS	Pink salmon (<i>Oncorhynchus gorbuscha</i>), juvenile	N/A	N/A	N/A	N/A	
		Chum salmon (<i>Oncorhynchus keta</i>), juveniles	N/A	N/A	N/A	N/A	
		Coho salmon (<i>Oncorhynchus kisutch</i>), juvenile	N/A	N/A	N/A	N/A	
		Landlocked masu salmon (<i>Oncorhynchus masou masou</i>), juvenile	N/A	N/A	N/A	N/A	
		Rainbow trout (<i>Oncorhynchus mykiss</i>)	N/A	N/A	N/A	N/A	
		Sockeye salmon (<i>Oncorhynchus nerka</i>)	N/A	N/A	N/A	N/A	
		Chinook salmon (<i>Oncorhynchus tshawytscha</i>)	N/A	N/A	N/A	N/A	
		Atlantic salmon (<i>Salmo salar</i>)	N/A	N/A	N/A	N/A	
		Brown Trout (<i>Salmo trutta</i>)	N/A	N/A	N/A	N/A	
		Arctic char (<i>Salvelinus alpinus</i>)	N/A	N/A	N/A	N/A	
		Southern Asian dolly varden (<i>Salvelinus curilus</i>)	N/A	N/A	N/A	N/A	
		Brook trout (<i>Salvelinus fontinalis</i>)	N/A	N/A	N/A	N/A	
White-spotted char (<i>Salvelinus leucomaenis pluvius</i>)	N/A	N/A	N/A	N/A			
Amine functionalized lignin	No CAS	Pink salmon (<i>Oncorhynchus gorbuscha</i>), juvenile	N/A	N/A	N/A	N/A	
		Chum salmon (<i>Oncorhynchus keta</i>), juveniles	N/A	N/A	N/A	N/A	
		Coho salmon (<i>Oncorhynchus kisutch</i>), juvenile	N/A	N/A	N/A	N/A	
		Landlocked masu salmon (<i>Oncorhynchus masou masou</i>), juvenile	N/A	N/A	N/A	N/A	
		Rainbow trout (<i>Oncorhynchus mykiss</i>)	N/A	N/A	N/A	N/A	
		Sockeye salmon (<i>Oncorhynchus nerka</i>)	N/A	N/A	N/A	N/A	
		Chinook salmon (<i>Oncorhynchus tshawytscha</i>)	N/A	N/A	N/A	N/A	
		Atlantic salmon (<i>Salmo salar</i>)	N/A	N/A	N/A	N/A	
		Brown Trout (<i>Salmo trutta</i>)	N/A	N/A	N/A	N/A	
		Arctic char (<i>Salvelinus alpinus</i>)	N/A	N/A	N/A	N/A	
		Southern Asian dolly varden (<i>Salvelinus curilus</i>)	N/A	N/A	N/A	N/A	
		Brook trout (<i>Salvelinus fontinalis</i>)	N/A	N/A	N/A	N/A	
White-spotted char (<i>Salvelinus leucomaenis pluvius</i>)	N/A	N/A	N/A	N/A			
Rambutan peel extract	No CAS	Pink salmon (<i>Oncorhynchus gorbuscha</i>), juvenile	N/A	N/A	N/A	N/A	
		Chum salmon (<i>Oncorhynchus keta</i>), juveniles	N/A	N/A	N/A	N/A	
		Coho salmon (<i>Oncorhynchus kisutch</i>), juvenile	N/A	N/A	N/A	N/A	
		Landlocked masu salmon (<i>Oncorhynchus masou masou</i>), juvenile	N/A	N/A	N/A	N/A	
		Rainbow trout (<i>Oncorhynchus mykiss</i>)	N/A	N/A	N/A	N/A	
		Sockeye salmon (<i>Oncorhynchus nerka</i>)	N/A	N/A	N/A	N/A	
		Chinook salmon (<i>Oncorhynchus tshawytscha</i>)	N/A	N/A	N/A	N/A	
		Atlantic salmon (<i>Salmo salar</i>)	N/A	N/A	N/A	N/A	
		Brown Trout (<i>Salmo trutta</i>)	N/A	N/A	N/A	N/A	
		Arctic char (<i>Salvelinus alpinus</i>)	N/A	N/A	N/A	N/A	
		Southern Asian dolly varden (<i>Salvelinus curilus</i>)	N/A	N/A	N/A	N/A	
		Brook trout (<i>Salvelinus fontinalis</i>)	N/A	N/A	N/A	N/A	
White-spotted char (<i>Salvelinus leucomaenis pluvius</i>)	N/A	N/A	N/A	N/A			

Chemical Name	CAS No.	Species	Parent Compound		Quinone		Citations
			Acute LC ₅₀ (Lowest Reported) (Flow Conditions, Exposure Measurement)	Duration of Exposure	Acute LC ₅₀ (Lowest Reported) (Flow Conditions, Exposure Measurement)	Duration of Exposure	
			µg/L	hr	µg/L	hr	
Octyl Gallate	1034-01-1	Pink salmon (<i>Oncorhynchus gorbuscha</i>), juvenile	N/A	N/A	N/A	N/A	
		Chum salmon (<i>Oncorhynchus keta</i>), juveniles	N/A	N/A	N/A	N/A	
		Coho salmon (<i>Oncorhynchus kisutch</i>), juvenile	N/A	N/A	N/A	N/A	
		Landlocked masu salmon (<i>Oncorhynchus masou masou</i>), juvenile	N/A	N/A	N/A	N/A	
		Rainbow trout (<i>Oncorhynchus mykiss</i>)	N/A	N/A	N/A	N/A	
		Sockeye salmon (<i>Oncorhynchus nerka</i>)	N/A	N/A	N/A	N/A	
		Chinook salmon (<i>Oncorhynchus tshawytsch a</i>)	N/A	N/A	N/A	N/A	
		Atlantic salmon (<i>Salmo salar</i>)	N/A	N/A	N/A	N/A	
		Brown Trout (<i>Salmo trutta</i>)	N/A	N/A	N/A	N/A	
		Arctic char (<i>Salvelinus alpinus</i>)	N/A	N/A	N/A	N/A	
		Southern Asian dolly varden (<i>Salvelinus curilus</i>)	N/A	N/A	N/A	N/A	
		Brook trout (<i>Salvelinus fontinalis</i>)	N/A	N/A	N/A	N/A	
White-spotted char (<i>Salvelinus leucomaenis pluvius</i>)	N/A	N/A	N/A	N/A			
Nano calcium carbonate surface modified by gallic acid	No CAS	Pink salmon (<i>Oncorhynchus gorbuscha</i>), juvenile	N/A	N/A	N/A	N/A	
		Chum salmon (<i>Oncorhynchus keta</i>), juveniles	N/A	N/A	N/A	N/A	
		Coho salmon (<i>Oncorhynchus kisutch</i>), juvenile	N/A	N/A	N/A	N/A	
		Landlocked masu salmon (<i>Oncorhynchus masou masou</i>), juvenile	N/A	N/A	N/A	N/A	
		Rainbow trout (<i>Oncorhynchus mykiss</i>)	N/A	N/A	N/A	N/A	
		Sockeye salmon (<i>Oncorhynchus nerka</i>)	N/A	N/A	N/A	N/A	
		Chinook salmon (<i>Oncorhynchus tshawytscha</i>)	N/A	N/A	N/A	N/A	
		Atlantic salmon (<i>Salmo salar</i>)	N/A	N/A	N/A	N/A	
		Brown Trout (<i>Salmo trutta</i>)	N/A	N/A	N/A	N/A	
		Arctic char (<i>Salvelinus alpinus</i>)	N/A	N/A	N/A	N/A	
		Southern Asian dolly varden (<i>Salvelinus curilus</i>)	N/A	N/A	N/A	N/A	
		Brook trout (<i>Salvelinus fontinalis</i>)	N/A	N/A	N/A	N/A	
White-spotted char (<i>Salvelinus leucomaenis pluvius</i>)	N/A	N/A	N/A	N/A			
N-1-Methylheptyl-N'-phenyl-p-phenylenediamine (8PPD or UOP 688)	15233-47-3	Pink salmon (<i>Oncorhynchus gorbuscha</i>), juvenile	N/A	N/A	N/A	N/A	
		Chum salmon (<i>Oncorhynchus keta</i>), juveniles	N/A	N/A	N/A	N/A	
		Coho salmon (<i>Oncorhynchus kisutch</i>), juvenile	N/A	N/A	N/A	N/A	
		Landlocked masu salmon (<i>Oncorhynchus masou masou</i>), juvenile	N/A	N/A	N/A	N/A	
		Rainbow trout (<i>Oncorhynchus mykiss</i>)	N/A	N/A	N/A	N/A	
		Sockeye salmon (<i>Oncorhynchus nerka</i>)	N/A	N/A	N/A	N/A	
		Chinook salmon (<i>Oncorhynchus tshawytscha</i>)	N/A	N/A	N/A	N/A	
		Atlantic salmon (<i>Salmo salar</i>)	N/A	N/A	N/A	N/A	
		Brown Trout (<i>Salmo trutta</i>)	N/A	N/A	N/A	N/A	
		Arctic char (<i>Salvelinus alpinus</i>)	N/A	N/A	N/A	N/A	
		Southern Asian dolly varden (<i>Salvelinus curilus</i>)	N/A	N/A	N/A	N/A	
		Brook trout (<i>Salvelinus fontinalis</i>)	N/A	N/A	N/A	N/A	
White-spotted char (<i>Salvelinus leucomaenis pluvius</i>)	N/A	N/A	N/A	N/A			

Chemical Name	CAS No.	Species	Parent Compound		Quinone		Citations
			Acute LC ₅₀ (Lowest Reported) (Flow Conditions, Exposure Measurement)	Duration of Exposure	Acute LC ₅₀ (Lowest Reported) (Flow Conditions, Exposure Measurement)	Duration of Exposure	
			µg/L	hr	µg/L	hr	
Specialized carbon nanotube mixture	No CAS	Pink salmon (<i>Oncorhynchus gorbuscha</i>), juvenile	N/A	N/A	N/A	N/A	
		Chum salmon (<i>Oncorhynchus keta</i>), juveniles	N/A	N/A	N/A	N/A	
		Coho salmon (<i>Oncorhynchus kisutch</i>), juvenile	N/A	N/A	N/A	N/A	
		Landlocked masu salmon (<i>Oncorhynchus masou masou</i>), juvenile	N/A	N/A	N/A	N/A	
		Rainbow trout (<i>Oncorhynchus mykiss</i>)	N/A	N/A	N/A	N/A	
		Sockeye salmon (<i>Oncorhynchus nerka</i>)	N/A	N/A	N/A	N/A	
		Chinook salmon (<i>Oncorhynchus tshawytscha</i>)	N/A	N/A	N/A	N/A	
		Atlantic salmon (<i>Salmo salar</i>)	N/A	N/A	N/A	N/A	
		Brown Trout (<i>Salmo trutta</i>)	N/A	N/A	N/A	N/A	
		Arctic char (<i>Salvelinus alpinus</i>)	N/A	N/A	N/A	N/A	
		Southern Asian dolly varden (<i>Salvelinus curilus</i>)	N/A	N/A	N/A	N/A	
		Brook trout (<i>Salvelinus fontinalis</i>)	N/A	N/A	N/A	N/A	
		White-spotted char (<i>Salvelinus leucomaenis pluvius</i>)	N/A	N/A	N/A	N/A	

Notes:

a.i. = Active Ingredient; CAS No. = Chemical Abstracts Service Number; hr = Hour; LC₅₀ = Median Lethal Concentration; N/A = Not Available; N/R = Not Reported.

Table 5.5 Scoring Matrix – Human Health Endpoints¹

Hazard Endpoint	Classification	Concentration in Product			
		<10%	10-29%	30-59%	60-100%
Carcinogenicity	Category 1	100	100	100	100
	Category 2/Prop 65	75	75	75	75
	Data Gap	25	25	50	50
Acute Toxicity	Category 1	75	75	100	100
	Category 2	50	50	75	75
	Category 3	10	25	50	50
	Category 4	5	5	10	10
	Data Gap	5	10	25	50
Mutagenicity ²	Category 1	50	50	50	50
	Category 2	25	25	25	25
	Data Gap	25	25	50	50
Reproductive Toxicity ²	Category 1	50	50	50	50
	Category 2/Prop 65	25	25	25	25
	Data Gap	25	25	50	50
Developmental Toxicity ²	Category 1	50	50	50	50
	Category 2/Prop 65	25	25	25	25
	Data Gap	25	25	50	50
Endocrine ³	EU Priority List or Endocrine concern	25	25	25	25
	Data gap	10	10	10	10
Systemic Toxicity/Organ Toxicity – Single Dose ²	Category 1	25	25	50	50
	Category 2	10	10	25	25
	Category 3	5	5	15	15
	Data Gap	5	10	25	50
Systemic Toxicity/Organ Toxicity – Repeated Dose ²	Category 1	25	25	50	50
	Category 2	10	10	25	25
	Data Gap	5	10	25	50
Skin Sensitizer ⁴	Category 1	25	25	50	50
	Data Gap	5	10	25	50
Respiratory Sensitizer ⁴	Category 1	25	25	50	50
	Data Gap	5	10	25	50
Eye Irritant ⁵	Category 1	5	10	25	25
	Category 2	5	5	10	10
	Data Gap	5	10	25	25
Skin Irritant ⁵	Category 1	5	10	25	25
	Category 2	5	5	10	10
	Data Gap	5	10	25	25
Not Required to Be Classified/Not Listed		0	0	0	0

Notes:

AA = Alternatives Analysis; CSI = Chemical Scoring Index; EU = European Union; GHS = Globally Harmonized System of Classification and Labelling of Chemicals; SCP = Safer Consumer Products.

(1) The original CSI approach did not evaluate products if "more than 30% of [the] product's composition is due to the contribution of components with 'No Data Available,'" with the idea that the product will be re-evaluated at a later time "when more information may be available" (Verslycke *et al.*, 2014). We did not follow this approach, because the SCP regulations do not require additional testing, and the timeframe for compliance would not allow for this. Additionally, the original CSI approach does not penalize data gaps on an *endpoint by endpoint* basis. This approach only penalizes a product if <30% of its composition is accounted for by components with data gaps (although the number of data gaps is immaterial), with a singular maximum penalty score of 100 for the environmental categories, 100 for the human health categories, and 50 for the physical

categories. If chemicals with data gaps account for $\geq 30\%$ of a product's composition, the product would be classified as "Do Not Evaluate." Thus, the CSI approach lacks granularity in terms of how many or which health endpoints have missing data. For this AA, we added endpoint by endpoint penalty scores for data gaps, which is more conservative than the CSI approach. These data gap scores were assigned based on hazard severity (*i.e.*, the maximum carcinogenicity and mutagenicity data gaps are scored 50 versus 10 for endocrine disruption). Also, in general, data gap penalty scores are lower than the Category 1 hazard scores for the same endpoint, and the data gap penalty scores generally decrease with decreasing chemical concentrations, except for some categories of particular concern (*e.g.*, Category 1 carcinogens).

(2) Under the original CSI approach, scores did not differ between these endpoints. To provide more granularity in the scoring, for this AA, we adopted the maximum CSI score for Category 1 hazards for all of the abovementioned hazard endpoints. However, we scaled down to a lower score for subsequent subcategories (approximately 50% of the Category 1 score for Category 2 and so on). This approach is in line with the spirit of the GHS and CSI.

(3) Endocrine hazard was moved from ecological toxicity, under the CSI to human health toxicity, under this AA's approach. Additionally, we used a score of 25 instead of the original 50 in the CSI for endocrine disruptors, because the EU's Endocrine Disruptor Priority List, which we used in this assessment, is a listing of chemicals with potential endocrine risk that should be explored *via* testing, rather than a list based on studies showing actual effects. In contrast, the maximum score for mutagenicity is 50 and is based on positive findings of a mutagenic effect.

(4) We created separate skin and respiratory sensitization categories from the original CSI's "sensitizer" category, to be consistent with the SCP regulations' required toxicity categories. Additionally, we used a maximum score of 50 instead of the original 25 in the CSI for skin and respiratory sensitization. This is because the original CSI approach was developed for oil and gas applications, in which sensitization was less of an issue. Because sensitization is an important hazard for worker exposure, we increased the maximum score for these endpoints.

(5) We created separate categories for eye and skin irritation from the CSI's "irritant" category, to be more consistent with the SCP regulations' required toxicity categories. We assigned a maximum data gap score of 25 for products in which components with no data account for more than 30% of the composition, matching the score of 25 for Category 1 skin or eye irritants, because these are common hazards.

Table 5.6 Scoring Matrix – Ecological Health Endpoints¹

Hazard Endpoint	Classification	Concentration in Product			
		<10%	10-29%	30-59%	60-100%
Acute Aquatic Toxicity	Category 1	25	50	75	100
	Category 2	10	25	50	75
	Category 3	5	10	25	50
	Data Gap	10	25	50	75
Chronic Aquatic Toxicity ²	Category 1	25	50	75	100
	Category 2	10	25	50	75
	Category 3	5	10	25	50
	Data Gap	10	25	50	75
Terrestrial Toxicity ³	Yes	25	50	75	100
	Data Gap	0	0	0	0
Bioaccumulative	Yes	50	50	50	50
	Data Gap	25	25	25	25
Persistent	Persistent	50	50	50	50
	Inherently Biodegradable	10	10	10	10
	Readily Biodegradable	0	0	0	0
	Data Gap	25	25	25	25
Not Required to Be Classified		0	0	0	0

Notes:

AA = Alternatives Assessment; CSI = Chemical Scoring Index; SCP = Safer Consumer Products.

- (1) The original CSI approach did not evaluate products if "more than 30% of [the] product's composition is due to the contribution of components with 'No Data Available,'" with the idea that the product will be re-evaluated at a later time "when more information may be available" (Verslycke *et al.*, 2014). We did not follow this approach, because the SCP regulations do not require additional testing, and the timeframe for compliance would not allow for this. Additionally, the original CSI approach does not penalize data gaps on an *endpoint by endpoint* basis. This approach only penalizes a product if <30% of its composition is accounted for by components with data gaps (although the number of data gaps is immaterial), with a singular maximum penalty score of 100 for the environmental categories, 100 for the human health categories, and 50 for the physical categories. If chemicals with data gaps account for ≥30% of a product's composition, the product would be classified as "Do Not Evaluate." Thus, the CSI approach lacks granularity in terms of how many or which health endpoints have missing data. For this Abridged AA, we added endpoint by endpoint penalty scores for data gaps, which is more conservative than the CSI approach. The data gap penalty scores are lower than the Category 1 hazard scores for the same endpoint, and the data gap penalty scores generally decrease with decreasing chemical concentrations, except for certain endpoints of particular concern (*i.e.*, persistent and bioaccumulative).
- (2) The CSI does not have scores for chronic aquatic toxicity. Thus, the CSI's scores for acute aquatic toxicity were used.
- (3) The CSI does not have scores for terrestrial toxicity. Thus, we created scores for this endpoint. However, because many chemicals lack data for this endpoint, the data gap penalty score was zero.

Table 5.7 Scoring Matrix – Physical/Chemical Hazards¹

Hazard Endpoint	Classification	Concentration in Product			
		<10%	10-29%	30-59%	60-100%
Ozone Depletion Potential	Yes	50	50	50	50
Direct Global Warming Contributor	Yes	10	25	50	75
Flammability (Liquid or Solid)	Category 1	25	50	75	100
	Category 2	10	25	50	75
	Category 3	5	10	25	50
VOC Contributing to Tropospheric Ozone Formation ²	Yes	10	25	50	75
	Data Gap	5	10	25	25
"No" or Data Gap for Any Category Besides VOC		0	0	0	0

Notes:

AA = Alternatives Assessment; CSI = Chemical Scoring Index; SCP = Safer Consumer Products; VOC = Volatile Organic Compound.

(1) The original CSI approach did not evaluate products if "more than 30% of [the] product's composition is due to the contribution of components with 'No Data Available,'" with the idea that the product will be re-evaluated at a later time "when more information may be available" (Verslycke *et al.*, 2014). We did not follow this approach, because the SCP regulations do not require additional testing, and the timeframe for compliance would not allow for this. Additionally, the original CSI approach does not penalize data gaps on an *endpoint by endpoint* basis. This approach only penalizes a product if <30% of its composition is accounted for by components with data gaps (although the number of data gaps is immaterial), with a singular maximum penalty score of 100 for the environmental categories, 100 for the human health categories, and 50 for the physical categories. If chemicals with data gaps account for ≥30% of a product's composition, the product would be classified as "Do Not Evaluate." Thus, the CSI approach lacks granularity in terms of how many or which health endpoints have missing data. For this AA, we added endpoint by endpoint penalty scores for data gaps, which is more conservative than the CSI approach. The data gap penalty scores are lower than the data-supported hazard scores for the same endpoint, and data gap penalty scores generally decrease with decreasing chemical concentrations.

(2) For this endpoint, we used a maximum score of 75 instead of the original maximum score of 50 in the CSI. Because VOCs' contribution to ozone formation is an important hazard for products that are used in urban areas, and because smog formation is a particular concern for California cities, we increased the maximum score for this endpoint.

Table 5.8 Chemical-Specific Hazard Scoring Summary

Class of Compound	Chemical	CAS	Human Health Score	Environmental Score	Physical Score	Total Score ¹	Notes
Current Priority Product Chemical of Concern							
Phenylene Diamine related	N-(1,3-dimethylbutyl)-N'-phenyl-p-phenylenediamine (6PPD)	793-24-8	125	150	0	275	Data-rich. GreenScreen™ Benchmark 1 - Avoid - Chemical of High Concern
Potential Alternatives							
Phenylene Diamine	N-(1,4-dimethylpentyl)-N'-phenyl-p-phenylenediamine (7PPD)	3081-01-4	120	150	0	270	Data-rich. Suspected PBT according to ECHA, evaluation in progress. GreenScreen Benchmark 1 - Avoid - Chemical of High Concern
Phenylene Diamine	N-isopropyl-N'-phenyl-p-phenylenediamine (IPPD)	101-72-4	150	100	0	250	Data-rich. GreenScreen™ assessment used surrogate 6PPD for some endpoints. GreenScreen™ Benchmark 1 - Avoid - Chemical of High Concern
Phenylene Diamine	N-cyclohexyl-N'-phenyl-p-phenylenediamine (CPPD)	101-87-1	Not assigned based on complete data gap	Not assigned based on complete data gap	Not assigned based on complete data gap	Not assigned based on mostly data gap	No hazard data
Phenylene Diamine	N,N'-diphenyl-p-phenylenediamine (DPPD)	74-31-7	80	150	0	230	Data-rich
Phenylene Diamine related	N-1,3-dimethyl butyl-N'-phenyl quinone diimine (6QDI)	52870-46-9	175	150	0	325	Many data gaps. GreenScreen™ Benchmark 1 - Avoid - Chemical of High Concern. GreenScreen™ assessment used surrogates, 6PPD, for most endpoints.
Dihydroquinoline	Polymerized 2,2,4-trimethyl-1,2-dihydroquinoline (TMQ)	26780-96-1	170	70	0	240	GreenScreen™ assessment used surrogate TMQ oligomer and ethoxyquin for most endpoints. GreenScreen™ Benchmark 2 - Use but search for safer substitutes. Classified as Cat. 1 for target organ toxicity, both single and repeated exposure.
Phenylene Diamine	N,N'-Bis(1,4-dimethylpentyl)-p-phenylenediamine (77PD)	3081-14-9	80	100	0	180	Data-rich. GreenScreen™ Benchmark 2 - Use but search for safer substitutes
Diphenyl amine	4,4'-Dioctyldiphenylamine (DOPD)	101-67-7	Not assigned based on complete data gap	Not assigned based on complete data gap	Not assigned based on complete data gap	Not assigned based on complete data gap	No hazard data
Phenylene diamine	N,N'-Ditolyl-p-phenylenediamine (Commercial DTPD)	68953-84-4	55	150	0	205	Data-rich. Suspected PBT according to ECHA, evaluation in progress. Proposed as reproductive/developmental toxicity Category 1B under EU harmonized classification, classification not adopted yet.
Phenylene Diamine	N,N'-Dicyclohexyl-p-phenylenediamine (CCPD)	4175-38-6	115	150	0	265	Many data gaps. GreenScreen™ Benchmark 1 - Avoid - Chemical of High Concern. GreenScreen™ assessment used surrogates, 44PD and 77PD, for most endpoints.
Phenylene diamine	Diaryl-p-phenylene diamine (DAPD is a class, main commercial DAPD is DTPD CASRN 68953-84-4)	68953-84-4	55	150	0	205	Data-rich. Suspected PBT according to ECHA, evaluation in progress. Proposed as reproductive/developmental toxicity Category 1B under EU harmonized classification, classification not adopted yet.
Phenylene diamine	N,N'-Di-2-naphthyl-p-phenylenediamine (DNPDA)	93-46-9	Not assigned based on complete data gap	Not assigned based on complete data gap	Not assigned based on complete data gap	Not assigned based on complete data gap	No hazard data
Metal dithiocarbamate	Nickel dibutylidithiocarbamate (NBC)	13927-77-0	170	50	0	220	Data-rich. GreenScreen™ Benchmark 1 - Avoid - Chemical of High Concern. On many regulatory restriction lists due to nickel.

Class of Compound	Chemical	CAS	Human Health Score	Environmental Score	Physical Score	Total Score ¹	Notes
Dihydroquinoline	Ethoxyquin	91-53-2	135	70	0	205	Data-rich. GreenScreen™ Benchmark 2 - Use but search for safer substitutes
Sulfur compound	Dilauryl thiodipropionate	123-28-4	40	0	0	40	Data-rich. GreenScreen™ Benchmark 3 _{dg} - Use but still opportunity for improvement
Phenylene Diamine	N'-Phenyl-N-Fluorenyl-Para-Phenylenediamine	No CAS	Not assigned based on complete data gap	Not assigned based on complete data gap	Not assigned based on complete data gap	Not assigned based on complete data gap	No hazard data
Phenylene Diamine	N-(p-phenylthiomethylphenyl)-N'-(1,3 dimethyl-butyl)-p-phenylenediamine	No CAS	Not assigned based on complete data gap	Not assigned based on complete data gap	Not assigned based on complete data gap	Not assigned based on complete data gap	No hazard data
Phenylene Diamine	4-(2,5-dimethyl-1H-pyrrol-1-yl)-N-phenylaniline	No CAS	Not assigned based on complete data gap	Not assigned based on complete data gap	Not assigned based on complete data gap	Not assigned based on complete data gap	No hazard data
Phenylene Diamine	N,N - (ethane-1,2-diyl) bis (N-phenylbenzene-1 4-diamine [example chemical from patent])	No CAS	Not assigned based on complete data gap	Not assigned based on complete data gap	Not assigned based on complete data gap	Not assigned based on complete data gap	No hazard data
Phenylene Diamine	4-N-(2,3-dimethylphenyl)-1-N-phenylbenzene-1,4-diamine- R1 and R2 are methyl	No CAS	Not assigned based on complete data gap	Not assigned based on complete data gap	Not assigned based on complete data gap	Not assigned based on complete data gap	No hazard data
Phenylene Diamine (Kruger)	RU997, Irgazone 997 (Reaction product of N-phenyl-N'-(1,3dimethylbutyl)-p-phenylenediamine with an alkyl glycidylthioether)	444992-04-5	130	65	0	195	Almost entirely data gap, other than skin sensitization and aquatic toxicity
Phenylene Diamine	4-[4-(4-Methylpentan-2-ylamino)anilino]phenol	No CAS	Not assigned based on complete data gap	Not assigned based on complete data gap	Not assigned based on complete data gap	Not assigned based on complete data gap	No hazard data
Phenylene diamine	Representative example from class (4-((4-(dimethylamino)phenyl)amino)phenol)	6358-22-1	Not assigned based on complete data gap	Not assigned based on complete data gap	Not assigned based on complete data gap	Not assigned based on complete data gap	No hazard data
Dihydroquinoline	N,N-diethyl-2,2,4-trimethyl-1H-quinolin-6-amine (R=N(C ₂ H ₅) ₂)	No CAS	Not assigned based on complete data gap	Not assigned based on complete data gap	Not assigned based on complete data gap	Not assigned based on complete data gap	No hazard data
Hindered amine	N,N'-Dibenzyl-p-xylene-alpha,alpha'-diamine-	25790-41-4	Not assigned based on complete data gap	Not assigned based on complete data gap	Not assigned based on complete data gap	Not assigned based on complete data gap	No hazard data
Triazine	2,4,6-tris-(N-1,4-dimethylpentyl-para-phenylenediamino)-1,3,5triazine (Durazone 37 or TAPDT)	121246-28-4	50	100	0	150	Data rich
Phenylnaphthyl amines	N-Phenyl-1-naphthylamine	90-30-2	45	150	0	195	Data rich
Phenylnaphthyl amines	N-Phenyl-2-naphthylamine	135-88-6	180	45	0	225	Data rich - Classified as a Cat. 2 carcinogen among other hazards

Class of Compound	Chemical	CAS	Human Health Score	Environmental Score	Physical Score	Total Score ¹	Notes
Phenol	[2-Methyl-4,6-bis((octylthio)methyl)phenol (Irganox 1520)	110553-27-0	30	10	0	40	Data rich
Inorganic	Graphene	1034343-98-0	55	85	0	140	Data rich. There are worker inhalation concerns due to nano particles
Hydrazine	1,1' -Pentamethylenebis(2,2-Di-n- Butylhydrazine)	No CAS	Not assigned based on complete data gap	Not assigned based on complete data gap	Not assigned based on complete data gap	Not assigned based on complete data gap	No data
Nitrone + Phenolic AO	α - C-4- hydroxy- 3,5- dimethylphenyl - N-isopropyl and Lowinox WSP	Nitrone as a class, no CAS and Lowinox WSP - 77-62-3	5 (for Lowinox WSP, however, no information on nitrone as a class)	75 (for Lowinox WSP, however, no information on nitrone as a class)	0 (for Lowinox WSP, however, no information on nitrone as a class)	Not assigned based on lack of data for nitrone as a class	Data rich for Lowinox WSP - 77-62-3; however, no information on nitrone as a class
Phenothiazine	N-(4-methylpentan-2-yl)-10H-phenothiazin-3-amine	No CAS	Not assigned based on complete data gap	Not assigned based on complete data gap	Not assigned based on complete data gap	Not assigned based on complete data gap	No hazard data
Amine	7-(4-methylpentan-2-ylamino)-2,3,4,10-tetrahydro-1H-acridin-9-one	No CAS	Not assigned based on complete data gap	Not assigned based on complete data gap	Not assigned based on complete data gap	Not assigned based on complete data gap	No hazard data
Amine	2-cyclohexyl-N-(4-methylpentan-2-yl)-1H-indol-5-amine	No CAS	Not assigned based on complete data gap	Not assigned based on complete data gap	Not assigned based on complete data gap	Not assigned based on complete data gap	No hazard data
Amine	4-(1H-indol-2-yl)-N-(4-methylpentan-2-yl)aniline	No CAS	Not assigned based on complete data gap	Not assigned based on complete data gap	Not assigned based on complete data gap	Not assigned based on complete data gap	No hazard data
Nitrone	α - C-4- Hydroxy- 3,5- dimethylphenyl-N-tert. butyl nitrone	No CAS	Not assigned based on complete data gap	Not assigned based on complete data gap	Not assigned based on complete data gap	Not assigned based on complete data gap	No hazard data
Polymeric amine functionalized lignin	Amine functionalized lignin	No CAS	Not assigned based on complete data gap	Not assigned based on complete data gap	Not assigned based on complete data gap	Not assigned based on complete data gap	No hazard data
Gallate related	Rambutan peel extract	No CAS	Not assigned based on complete data gap	Not assigned based on complete data gap	Not assigned based on complete data gap	Not assigned based on complete data gap	No hazard data

Class of Compound	Chemical	CAS	Human Health Score	Environmental Score	Physical Score	Total Score ¹	Notes
Gallate related	Octyl Gallate	1034-01-1	40	100	0	140	Some hazard data available. Propyl gallate was used as a read-across for some endpoints.
Gallate related	Nano calcium carbonate surface modified by gallic acid	No CAS	Not assigned based on complete data gap	Not assigned based on complete data gap	Not assigned based on complete data gap	Not assigned based on complete data gap	No hazard data. There are worker inhalation concerns due to nano particles.
Phenylene Diamine	N-1-Methylheptyl-N'-phenyl-p-phenylenediamine (8PPD or UOP 688)	15233-47-3	Not assigned based on complete data gap	Not assigned based on complete data gap	Not assigned based on complete data gap	Not assigned based on complete data gap	No hazard data
Inorganic	Specialized carbon nanotube mixture	No CAS	Not assigned based on complete data gap	Not assigned based on complete data gap	Not assigned based on complete data gap	Not assigned based on complete data gap	No hazard data. There are worker inhalation concerns due to nano particles.

Notes:

CAS = Chemical Abstracts Service Number; DG = Data Gap; ECHA = European Chemicals Agency; EU = European Union; PBT = Persistent, Bioaccumulative, and Toxic.

The Chemical Scoring Index (CSI) approach (Verslycke *et al.*, 2014) was modified to provide quantitative hazard scores. The higher the score, the worse the hazard profile; however, these scores should only be used as approximations of hazards (*i.e.*, ball parks), due to the underlying uncertainties.

(1) This is assuming that the concentration of the chemical in the tire is <10%.

Table 5.9 Physical-Chemical Properties

Chemical	CAS No.	SMILES	Molecular Weight	Density at 20°C (g/cm ³)	Log K _{ow} at 20°C (Octanol-Water Partition Coefficient, Describes Lipid Solubility)	Log K _{oa} at 25°C (Octanol-Air Partition Coefficient)	Log K _{oc} (Organic Carbon Partition Coefficient, Describes Sorption in Soil and Sediment)	K _{ow} ¹ (Henry's Law Constant at 25°C, atm-m ³ /mole)	Vapor Pressure (Saturated, mm Hg at 25°C)	Melting Point (°C at 1 atm)	Boiling Point ² (°C at 1 atm)	Water Solubility (mg/L at 25°C)	Physical State	Hydrolysis Rate Constant (L M ⁻¹ s ⁻¹)	Dissociation Constant at 20°C	Photolysis Rate Constant (s ⁻¹)	Standard Reduction Potential (V)	Air Diffusion Coefficient (Diffusivity) (cm ² /s) at 20°C and 1 atm	Water Diffusion Coefficient (Diffusivity) (cm ² /s) at 20°C and 1 atm	Reactivity/Electrophilicity Index	Environmental Half-life in Air (Days)	Environmental Half-life in Air (Hrs)
N-(1,3-dimethylbutyl)-N'-phenyl-p-phenylenediamine (6-PPD)	793-24-8	CC(C)CC(C)NC1=CC=C(C=C1)NC2=CC=CC=C2	268.41	0.995 at 50°C	4.68	11.542	4.363	3.36E-09	4.93E-06	121.5	369.67	2.83	Solid	NA	2.00E-07	1.63E-04	NA	4.22E-02	4.20E-06	NA	0.047	0.567
Possible alternatives																						
N-(1,4-dimethylpentyl)-N'-phenyl-p-phenylenediamine (7PPD)	3081-01-4	CC(C)CCC(C)NC1=CC=C(C=C1)NC2=CC=CC=C2	282.43	1.01	5.17	11.909	4.623	4.46E-09	2.11E-06	129.78	381.27	0.67	Liquid	NA	2.00E-07	1.63E-04	NA	4.10E-02	4.05E-06	NA	0.047	0.563
N-isopropyl-N'-phenyl-p-phenylenediamine (IPPD)	101-72-4	CC(C)NC1=CC=C(C=C1)NC2=CC=CC=C2	226.32	1.04	3.28	10.51	3.636	1.44E-09	7.11E-05	74	161	58.071	Solid	NA	1.58E-07	1.58E-7 - 1.74E-7	NA	4.66E-02	4.76E-06	NA	0.049	0.588
N-cyclohexyl-N'-phenyl-p-phenylenediamine (CPPD)	101-87-1	C1CCCC(C1)NC2=CC=C(C=C2)NC3=CC=CC=C3	266.39	NA	4.64	11.858	3.854	1.48E-09	1.24E-06	134.41	388.82	6.6544	Solid	NA	NA	NA	NA	4.24E-02	4.37E-06	NA	0.046	0.548
N,N'-diphenyl-p-phenylenediamine (DPPD)	74-31-7	C1=CC=C(C=C1)NC2=CC=C(C=C2)NC3=CC=CC=C3	260.34	1.268	4.04	12.117	4.715	2.05E-10	6.35E-09	144	220-225	1.5867	Solid	NA	NA	NA	NA	4.32E-02	4.56E-06	NA	0.053	0.642
N-1,3-dimethyl butyl-N'-phenyl quinone diimine (6QDI)	52870-46-9	CC(C)CC(C)N=C1C=CC(=NC2=CC=CC=C2)C=C1	266.39	NA	5.86	7.58	5.62	4.66E-04	4.85E-05	64.21	352.87	4.08E-02	Liquid	NA	NA	NA	NA	4.24E-02	4.21E-06	NA	0.088	1.055
Polymerized 2,2,4-trimethyl-1,2-dihydroquinoline (TMQ)	26780-96-1	Polymer	173.26	1.042 at 20°C	3.9 at 25°C	NA	NA	NA	< 4.8E-06	48	> 280	< 1.00E0	Solid	NA	Insignificant	NA	NA	5.29E-02	5.59E-06	NA	NA	2
N,N'-Bis(1,4-dimethylpentyl)-p-phenylenediamine (77PD)	3081-14-9	CC(C)CCC(C)NC1=CC=C(C=C1)NC(C)CC(C)C	304.52	0.909	6.3	11.701	4.532	9.72E-08	8.22E-06	112.67	364.35	0.074747	Liquid	NA	3.16E-08	8.96E-05	NA	3.91E-02	3.68E-06	NA	0.085	1.021
4,4'-Dioclyldiphenylamine (DOPD)	101-67-7	CCCCCCCCC1=CC=C(C=C1)NC2=CC=C(C=C2)CCCCCCCC	393.66	NA	11.26	13.819	7.016	6.76E-05	2.11E-09	184.89	477.99	3.94E-07	Solid	NA	NA	NA	NA	3.35E-02	3.20E-06	NA	0.049	0.586
N,N'-Ditolyl-p-phenylenediamine (Commercial DTPD)	68953-84-4	CC1=CC=C(C=C1)NC2=CC(=CC=C2)NC3=CC=C(C=C3)C	288.4	1.2	3.93	13.12	5.126	2.49E-10	1.01E-07	158.74	421.38	1.56E-01	Solid	NA	3.98E-02	Not sure where to find this	NA	4.07E-02	4.21E-06	NA	0.053	0.641
N,N'-Dicyclohexyl-p-phenylenediamine (CCPD)	4175-38-6	C1CCCC(C1)NC2=CC=C(C=C2)NC3CCCCC3	272.44	NA	5.24	11.599	2.992	1.07E-08	2.24E-06	131.43	379.45	4.4631	Solid	NA	NA	NA	NA	4.17E-02	4.21E-06	NA	0.077	0.926
Diaryl-p-phenylene diamine (DAPD)	68953-84-4	CC1=CC=C(C=C1)NC2=CC(=CC=C2)NC3=CC=C(C=C3)C	288.4	1.2	3.93	13.12	5.126	2.49E-10	1.01E-07	158.74	421.38	1.56E-01	Solid	NA	3.98E-02	Not sure where to find this	NA	4.07E-02	4.21E-06	NA	0.053	0.641
N,N'-Di-2-naphthyl-p-phenylenediamine (DNPPDA)	93-46-9	C1=CC=C2C=C(C=C2)C1=NC3=CC=C(C=C3)NC4=CC5=CC=CC=C5C=C4	360.46	NA	6.39	16.488	6.765	1.95E-12	1.43E-11	235	539.98	6.90E-04	Solid	NA	NA	NA	NA	3.60E-02	3.84E-06	NA	0.027	19.253
Nickel dibutylthiocarbamate (NBC)	13927-77-0	CCCCN(CCCC)C(=S)[S-].[Ni+2].CCCCN(CCCC)C(=S)[S-].[Ni+2]	467.43	1.301	5.44	9.34E-06	6.254	NA	3.98E-04	9.02E+01	296	8.31E+01	Solid: Particulate/powder	NA	NA	NA	NA	3.71E-02	3.30E-06	NA	0.058	0.691
Ethoxyquin	91-53-2	CCOC1=CC2=C(C=C1)NC(C=C2)C(C)C	217.31	1.031	3.87	8.875	3.104	2.42E-07	1.32E-04	104.68	123-125	20.093	Liquid	NA	2.75E-5 (at 22°C)	NA	NA	4.79E-02	4.89E-06	NA	0.083	1.001
Dilauryl thiodipropionate	123-28-4	O=C(OCCCCCCCCCCC)CCSCC(=O)OCCCCCCCCCCC	514.85	1.04	11.79	15.576	6.973	5.73E-07	8.89E-09	40-42	519.29	5.15E-07	Solid: Flakes	NA	NA	NA	NA	3.06E-02	2.76E-06	NA	0.205	2.465
N'-Phenyl-N-Fluorenyl-Para-Phenylenediamine	No CAS	C1=C(NC(C=C2)C=CC(=C1)NC(C1=CC2)=CC=C2)C(C=C2)C1=C2	348.45	NA	5.41	15.53	6.318	1.85E-12	1.59E-10	216.27	507.87	5.59E-03	Solid	NA	NA	NA	NA	0.0367	3.90E-06	NA	0.051	0.607
N'-Phenyl-N-Fluorenyl-Para-Phenylenediamine	No CAS	C1=CC=C(C=C1)NC(=CC=C1)NC(=CC=C2)C(C=C3)C(C=C4)C=C3C=C4)C=C1	349.45	NA	6.06	15.65	6.522	6.36E-12	1.25E-10	217.84	511.22	1.46E-03	Solid	NA	NA	NA	NA	0.0367	3.90E-06	NA	0.053	0.64
N-(p-phenylthiomethylphenyl)-N'-(1,3-dimethyl-butyl)-p-phenylenediamine	No CAS	CC(C)CC(C)NC1=CC=C(C=C1)NC2=CC=C(C=C2)CSC3=CC=CC=C3	390.59	NA	6.99	16.480	6.422	7.19E-12	3.74E-10	204.49	498.68	1.70E-03	Solid	NA	NA	NA	NA	3.52E-02	3.46E-06	NA	0.046	0.549
4-(2,5-dimethyl-1H-pyrrol-1-yl)-N-phenylaniline	No CAS	CC1=CC=C(N1C2=CC=C(C=C2)NC3=CC=CC=C3)C	262.36	NA	5.04	14.535	4.631	7.83E-12	5.47E-07	147.48	397.43	7.19E-01	Solid	NA	NA	NA	NA	4.29E-02	4.46E-06	NA	0.053	0.641
N,N - (ethane-1,2-diyl) bis (N-phenylbenzene 1,4-diamine or similar chemical 1-N-[2-(4-anilinoanilino)ethyl]-4-N-phenylbenzene-1,4-diamine	No CAS	C1=CC=C(C=C1)NC2=CC=C(C=C2)NCCNC3=CC=C(C=C3)NC4=CC=CC=C4	394.52	NA	4.4	19.709	6.87	1.20E-17	8.35E-12	235.45	548.93	4.34E-02	Solid	NA	NA	NA	NA	3.51E-02	3.53E-06	NA	0.048	0.58
4-N-(2,3-dimethylphenyl)-1-N-phenylbenzene-1,4-diamine- R1 and R2 are methyl	No CAS	CC1=C(C=C(C=C1)NC2=CC=C(C=C2)NC3=CC=CC=C3)C	288.4	NA	5.13	13.122	5.143	2.49E-10	1.07E-07	158.74	421.38	1.56E-01	Solid	NA	NA	NA	NA	4.07E-02	4.21E-06	NA	0.053	0.641
RU997 Irgazone 997 Reaction product of N-phenyl-N'-(1,3dimethylbutyl)-p-phenylenediamine with an alkyl glycidylthioether	444992-04-5	C1=CC=C(C=C1)NC1C=CC(=CC=1)N(C)C(O)SC(C)C(C)CCCCCCCC(C)C(C)C(C)C	526.87	NA	10.6	20.959	7.037	1.07E-12	1.16E-15	253.56	587.68	1.54E-05	Solid	NA	NA	NA	NA	2.98E-02	2.76E-06	NA	0.04	28.55
4-[4-(4-Methylpentan-2-ylamino)anilino]phenol	No CAS	CC(C)CC(C)NC1=CC=C(C=C1)NC2=CC=C(C=C2)O	284.4	NA	3.85	14.694	4.471	3.50E-13	6.70E-08	152.39	404.5	5.68E+00	Solid	NA	NA	NA	NA	4.18E-02	4.15E-06	NA	0.047	0.566

Chemical	CAS No.	SMILES	Molecular Weight	Density at 20°C (g/cm ³)	Log K _{ow} at 20°C (Octanol-Water Partition Coefficient, Describes Lipid Solubility)	Log K _{oa} at 25°C (Octanol-Air Partition Coefficient)	Log K _{oc} (Organic Carbon Partition Coefficient, Describes Sorption in Soil and Sediment)	K _{HL} ¹ (Henry's Law Constant at 25°C, atm-m ³ /mole)	Vapor Pressure (Saturated, mm Hg at 25°C)	Melting Point (°C at 1 atm)	Boiling Point ² (°C at 1 atm)	Water Solubility (mg/L at 25°C)	Physical State	Hydrolysis Rate Constant (L M ⁻¹ s ⁻¹)	Dissociation Constant at 20°C	Photolysis Rate Constant (s ⁻¹)	Standard Reduction Potential (V)	Air Diffusion Coefficient (Diffusivity) (cm ² /s) at 20°C and 1 atm	Water Diffusion Coefficient (Diffusivity) (cm ² /s) at 20°C and 1 atm	Reactivity/Electrophilicity Index	Environmental Half-life in Air (Days)	Environmental Half-life in Air (Hrs)
This is a class of compounds. Reference uses case where R1 and R2 are methyl; n,p and q are zero and m=1 and is in the para position. Representative example from class 4-((4-dimethylamino)phenyl)amino)phenol)	6358-22-1	CN(C)C1=CC=C(C=C1)NC2=CC=C(C=C2)O	228.3		2.64	12.788	3.28	1.74E-12	1.48E-06	132.28	361.66	3.74E+02	Solid	NA	NA	NA	NA	4.78E-02	4.92E-06	NA	0.053	0.633
N,N-diethyl-2,2,4-trimethyl-1H-quinolin-6-amine (R= N(C2H5)2)	No CAS	CCN(CC)C1=CC2=C(C=C1)NC(C=C2)C(C)C	244.38	NA	4.46	9.912	3.329	8.64E-08	2.19E-05	123.66	341.46	5.98E+00	Solid	NA	NA	NA	NA	4.44E-02	4.43E-06	NA	0.035	25.243
Mixed xylene diamines N,N'-Dibenzyl-p-xylylene-alpha,alpha'-diamine-	25790-41-4	Mixture																				
2,4,6-tris-(N-1,4-dimethylpentyl-para-phenylenediamino)-1,3,5-triazine, TAPDT	121246-28-4	CC(C)CCC(C)NC1=CC=C(C=C1)NC2=NC(=NC(=N2)NC3=CC=C(C=C3)NC(C)CCC(C)C)C)NC4=CC=C(C=C4)NC(C)CCC(C)C	694.03	1.07 at 20°C	11.9	30.903	11.407	2.43E-21	1.57E-19	54	225	6.94E-07	Solid	NA	NA	NA	NA	2.62E-02	2.40E-06	NA	0.038	27.144
N-Phenyl-1-naphthylamine	90-30-2	C1=CC=C(C=C1)NC2=CC=CC3=CC=CC=C3C2	219.29	1.16 at 20°C	4.28	9.576	4.473	1.03E-07	7.63E-06	62	335	3.96E+00	Solid	NA	1.17E-05	1.33E-04 - 2.02E-03	NA	4.66E-02	5.10E-06	NA	0.031	22.222
N-Phenyl-2-naphthylamine	135-88-6	C1=CC=C(C=C1)NC2=CC3=CC=CC=C3C=C2	219.29	1.242 at 25°C	4.38	9.756	4.464	1.03E-07	1.64E-06	108	395.5	1.26E+00	Solid	NA	NA	NA	NA	4.66E-02	5.10E-06	NA	0.031	22.222
Irganox 1520	110553-27-0	CCCCCCCCSCC1=CC=C(C=C1)C(O)CSCCCCCC	424.75	0.981 at 20°C	10.2	16.9	7.637	4.53E-09	2.13E-11	14	508.31	8.89E-06	Liquid	NA	2.51E-11	7.60E-11	NA	3.38E-02	3.13E-06	NA	0.143	1.721
Graphene	1034343-98-0	NA	NA	2.259 at 20°C	NA	NA	NA	NA	NA	>4000	NA	<3 mg/L	Solid: Powder	NA	NA	NA	NA	NA	NA	NA	NA	NA
1,1'-Pentamethylenebis(2,2-Di-n-Butylhydrazine)	No CAS	CCCC(CCCC)NCCCCN(CCCC)CCCC	356.64	NA	5.57	14.49	5.724	2.94E-11	2.21E-07	151.05	411.96	3.86E+03	Solid	NA	NA	NA	NA	3.66E-02	3.27E-06	NA	0.052	0.625
α-C-4-hydroxy-3,5-dimethylphenyl (Lowinox WSP). No number for nitron- N-isopropyl nitron and Lowinox WSP	Lowinox WSP - 77-62-3, No CAS for nitron	NA Mixture																				
N-(4-methylpentan-2-yl)-10H-phenothiazin-3-amine	No CAS	CC(C)CCC(C)NC1=CC2=C(C=C1)NC3=CC=CC=C3C2	298.45	NA	5.76	14.2	4.615	8.89E-11	1.14E-07	170.85	414.55	6.37E-01	Solid	NA	NA	NA	NA	4.13E-02	4.18E-06	NA	0.047	0.567
7-(4-methylpentan-2-ylamino)-2,3,4,10-tetrahydro-1H-acridin-9-one	No CAS	CC(C)CCC(C)NC1=CC2=C(C=C1)NC3=C(C2)O)CCCC3	298.43	NA	5.2	14.358	3.496	1.70E-11	7.60E-08	173.7	420.42	2.17E+00	Solid	NA	NA	NA	NA	4.06E-02	4.10E-06	NA	0.09	1.084
2-cyclohexyl-N-(4-methylpentan-2-yl)-1H-indol-5-amine	No CAS	CC(C)CCC(C)NC1=CC2=C(C=C1)NC(=C2)C3CCCCC3	298.48	NA	6.81	13.443	5.92	5.69E-09	1.11E-07	157.01	421.39	1.91E-01	Solid	NA	NA	NA	NA	3.96E-02	3.94E-06	NA	0.045	0.543
4-(1H-indol-2-yl)-N-(4-methylpentan-2-yl)aniline	No CAS	CC(C)CCC(C)NC1=CC=C(C=C1)C2=CC3=CC=CC=C3N2	292.43	NA	5.76	13.81	5.398	2.18E-10	1.99E-08	172.04	444.85	1.72E-01	Solid	NA	NA	NA	NA	4.03E-02	4.08E-06	NA	0.042	29.969
α-C-4-Hydroxy-3,5-dimethylphenyl-N-tert-butyl nitron	No CAS	C1/C=C(N+)(\O-))C(C)(C)=CC(C)=C(C(C)=C1)O	221.3	NA	1.83	14.249	4.264	9.32E-15	1.02E-09	191.87	455.63	5.11E+01	Solid	NA	NA	NA	NA	4.87E-02	4.83E-06	NA	0.436	5.227
Amine functionalized lignin	No CAS	NA, polymer																				
Rambutan peel extract	No CAS	NA, complex mixture																				
Nano Calcium Carbonate Surface Modified by Gallic Acid	No CAS	NA																				
Octyl Gallate	1034-01-1	CCCCCCCCOC(=O)C1=CC(=C(C=C1)O)O	282.33	NA	3.66	17.6	4.00	2.84E-16	1.95E-08	101-104	421.61	2.00E+01	Solid	7.99E-03	NA	NA	NA	4.44E-02	4.25E-06	NA	0.108	1.293
N-1-Methylheptyl-N'-phenyl-p-phenylenediamine (8PPD or UOP 688)	15233-47-3	CCCCCCC(C)NC1=CC=C(C=C1)NC2=CC=CC=C2	296.46	NA	5.74	12.36	4.96	5.92E-09	4.99E-07	145.77	399.87	1.57E-01	Solid	NA	NA	NA	NA	3.99E-02	3.92E-06	NA	0.047	0.56
Specialized carbon nanotube mixture	No CAS	NA, complex mixture																				

Notes:
CAS No. = Chemical Abstracts Service Registry Number; DG = Data Gap; Hrs = Hours; NA = Not available; OH = Hydroxyl Radical; SMILES = Simplified Molecular-Input Line-Entry System; TSCA = Toxic Substances Control Act; US EPA = United States Environmental Protection Agency; UVCB = Unknown or Variable Composition, Complex Reaction Products and Biological Materials.
Bolded text indicates experimental values. Non-bolded text indicates modeled or calculated values. If available, experimental melting point, boiling point, vapor pressure, and water solubility values listed in the table were manually entered for more accurate modeling in US EPA's EPI Suite software (US EPA, 2019b).
Data were mainly obtained from ECHA (2024) and US EPA's EPI Suite software (US EPA, 2019).
(1) Reference hierarchy of Henry's Law Constant sources in EPI Suite: (1) Vapor pressure/water solubility, if experimental data are available; (2) Group; (3) Bond.
(2) Boiling point: Preference was given to experimental value reported at 1 atm or 760 mm Hg. Otherwise, a modeled estimate from EPI Suite was used (US EPA, 2019b).

Table 5.10 Physical-Chemical Properties and Hazards of Transformation Products of 6PPD and Possible Alternative Chemicals

Chemical Name	CAS No.	SMILES	Transformation Product Name	Transformation Product CAS	Transformation Product SMILES	log K _{ow}	log K _{oc}	VP (saturated mm Hg at 25°C)	Water Solubility (mg/L)	ECHA Dossier GHS Conclusion	EU Persistent Bioaccumulative and Toxic	California Toxic Air Contaminant	California Proposition 65		
6PPD	793-24-8	CC(C)CC(C)NC1=CC=C(C=C1)NC2=CC=CC=C2	6PPD-quinone	2754428-18-5	CC(C)CC(C)NC1=CC(=O)C(=C1=O)NC2=CC=CC=C2	No information in ECHA dossier				No ECHA dossier; however, existing aquatic data indicates acute toxicity to fish.	Not listed	Not listed	Not listed		
			4-Hydroxydiphenylamine	122-37-2	C1=CC=C(C=C1)NC2=CC=C(C=C2)O	2.82 (From EPISUITE. Hansch, C <i>et al.</i> (1995))	No information in ECHA dossier				No useful information in ECHA dossier	Not listed	Not listed	Not listed	
			1,3-Dimethylbutylamine	108-09-8	CC(C)CC(C)N	No information in ECHA dossier			7.9 (From EPISUITE. Yaws, CL <i>et al.</i> (2001))		No ECHA dossier	Not listed	Not listed	Not listed	
			p-Benzoquinone	106-51-4	C1=CC(=O)C=CC1=O	Between 0.1 and 0.3 (at 23°C)	No information in ECHA dossier	2.93E-02	1.47E+04 (at 20°C)	Acute Tox. 3 (Oral), Aquatic Acute 1, Skin Irrit. 2, Eye Irrit. 2, STOT SE 3, Acute Tox. 3 (Inhalation), Aquatic Chronic 1, Muta. 2, Skin Sens. 1, Flam. Sol. 1	Not listed	Listed	Not listed		
			p-Hydroquinone	123-31-9	C1=CC(=CC=C1)O	0.59 (at 20°C)	1.585	2.40E-05	7.20E+04 (at 25°C)	Aquatic Acute 1, Carc. 2, Muta. 2, Eye Dam. 1, Acute Tox. 4 (Oral), Skin Sens. 1, Aquatic Chronic 1, Skin Sens. 1B	Not listed	Listed	Not listed		
			Aniline	62-53-3	C1=CC=C(C=C1)N	0.91 (at 25°C)	2.6	3.05E-01	3.50E+04 (at 20°C)	Carc. 2, STOT RE 1, Acute Tox. 3 (Dermal), Muta. 2, Eye Dam. 1, Acute Tox. 3 (Inhalation), Acute Tox. 3 (Oral), Aquatic Acute 1, Aquatic Chronic 1, Skin Sens. 1B	Not listed	Listed	Listed (Cancer)		
			N-Phenyl-p-benzoquinone-monoimine	2406-04-4	C1=CC=C(C=C1)N=C2C=CC(=O)C=C2	No information in ECHA dossier					No ECHA dossier	Not listed	Not listed	Not listed	
		N-(1,3-Dimethylbutyl)-N'-(phenyl)-1,4-benzoquinonediimine (6QDI)	52870-46-9		4.2 (at 25°C)	No information in ECHA dossier	7.50E-06	1.54E+01 (at 20°C)	6QDI is an oxidation product of 6PPD which is expected to form under hydrolytic conditions in the presence of oxygen. There is no information on ECHA about GHS conclusions for 6QDI.	Not listed	Not listed	Not listed			
N-(1,4-dimethylpentyl)-N'-phenyl-p-phenylenediamine (7PPD)	3081-01-4	CC(C)CCC(C)NC1=CC=C(C=C1)NC2=CC=CC=C2	4-Hydroxydiphenylamine	122-37-2	C1=CC=C(C=C1)NC2=CC=C(C=C2)O	2.82 (From EPISUITE. Hansch, C <i>et al.</i> (1995))	No information in ECHA dossier				No useful information in ECHA dossier	Not listed	Not listed	Not listed	
			N-Phenyl-p-benzoquinone-monoimine	2406-04-4	C1=CC=C(C=C1)N=C2C=CC(=O)C=C2	No information in ECHA dossier					No ECHA dossier	Not listed	Not listed	Not listed	
			1,4-Dimethylpentylamine	28292-43-5	CC(C)CCC(C)N	No information in ECHA dossier					No ECHA dossier	Not listed	Not listed	Not listed	
			p-Benzoquinone (pH 4 and 7)	106-51-4	C1=CC(=O)C=CC1=O	Between 0.1 and 0.3 (at 23°C)	No information in ECHA dossier	2.93E-02	1.47E+04 (at 20°C)	Acute Tox. 3 (Oral), Aquatic Acute 1, Skin Irrit. 2, Eye Irrit. 2, STOT SE 3, Acute Tox. 3 (Inhalation), Aquatic Chronic 1, Muta. 2, Skin Sens. 1, Flam. Sol. 1	Not listed	Listed	Not listed		
			p-Hydroquinone (pH 4)	123-31-9	C1=CC(=CC=C1)O	0.59 (at 20°C)	1.585	2.40E-05	7.20E+04 (at 25°C)	Aquatic Acute 1, Carc. 2, Muta. 2, Eye Dam. 1, Acute Tox. 4 (Oral), Skin Sens. 1, Aquatic Chronic 1, Skin Sens. 1B	Not listed	Listed	Not listed		
			Aniline (pH 4, 7, and 9)	62-53-3	C1=CC=C(C=C1)N	0.91 (at 25°C)	2.6	3.05E-01	3.50E+04 (at 20°C)	Carc. 2, STOT RE 1, Acute Tox. 3 (Dermal), Muta. 2, Eye Dam. 1, Acute Tox. 3 (Inhalation), Acute Tox. 3 (Oral), Aquatic Acute 1, Aquatic Chronic 1, Skin Sens. 1B	Not listed	Listed	Listed (Cancer)		
			4-(Phenylnitroso)benzen-1-olate (overoxidised 4-HDPA)	CAS not identified	NA	Unable to assess due to lack of CAS					Unable to assess due to lack of CAS	CAS not identified			
N-isopropyl-N'-phenyl-p-phenylenediamine (IPPD)	101-72-4	CC(C)NC1=CC=C(C=C1)NC2=CC=CC=C2	4-Hydroxydiphenylamine	122-37-2	C1=CC=C(C=C1)NC2=CC=C(C=C2)O	2.82 (From EPISUITE. Hansch, C <i>et al.</i> (1995))	No information in ECHA dossier				No useful information in ECHA dossier	Not listed	Not listed	Not listed	
			Benzo-quinoneimine-N-phenyl	2406-04-4 (most)	C1=CC=C(C=C1)N=C2C=CC(=O)C=C2	No information in ECHA dossier					No ECHA dossier	Not listed	Not listed	Not listed	
N-cyclohexyl-N'-phenyl-p-phenylenediamine (CPPD)	101-87-1	C1CCC(CC1)NC2=CC=C(C=C2)NC3=CC=CC=C3	No ECHA dossier available to support evaluation.										Not listed	Not listed	Not listed
N,N'-diphenyl-p-phenylenediamine (DPPD)	74-31-7	C1=CC=C(C=C1)NC2=CC=C(C=C2)NC3=CC=CC=C3	ECHA dossier contains no information on transformation products										Not listed	Not listed	Not listed

Chemical Name	CAS No.	SMILES	Transformation Product Name	Transformation Product CAS	Transformation Product SMILES	log K _{ow}	log K _{oc}	VP (saturated mm Hg at 25°C)	Water Solubility (mg/L)	ECHA Dossier GHS Conclusion	EU Persistent Bioaccumulative and Toxic	California Toxic Air Contaminant	California Proposition 65		
N-1,3-dimethyl butyl-N'-phenyl quinone diimine (6QDI)	52870-46-9	CC(C)CC(C)N=C1C=CC(=NC2=CC=CC=C2)C=C1	4-Hydroxydiphenylamine	122-37-2	C1=CC=C(C=C1)NC2=CC=C(C=C2)O	2.82 (From EPISUITE. Hansch, C <i>et al.</i> (1995))	No information in ECHA dossier			Acute Tox. 4, Skin Sens. 1, Aquatic Acute 1, Aquatic Chronic 1	Not listed	Not listed	Not listed		
			p-Benzoquinone	106-51-4	C1=CC(=O)C=CC1=O	Between 0.1 and 0.3 (at 23°C)	No information in ECHA dossier	2.93E-02	1.47E+04 (at 20°C)	Acute Tox. 3 (Oral), Aquatic Acute 1, Skin Irrit. 2, Eye Irrit. 2, STOT SE 3, Acute Tox. 3 (Inhalation), Aquatic Chronic 1, Muta. 2, Skin Sens. 1, Flam. Sol. 1	Not listed	Listed	Not listed		
			p-Hydroquinone	123-31-9	C1=CC(=CC=C1O)O	0.59 (at 20°C)	1.585	2.40E-05	7.20E+04 (at 25°C)	Aquatic Acute 1, Carc. 2, Muta. 2, Eye Dam. 1, Acute Tox. 4 (Oral), Skin Sens. 1, Aquatic Chronic 1, Skin Sens. 1B	Not listed	Listed	Not listed		
			Aniline	62-53-3	C1=CC=C(C=C1)N	0.91 (at 25°C)	2.6	3.05E-01	3.50E+04 (at 20°C)	Carc. 2, STOT RE 1, Acute Tox. 3 (Dermal), Muta. 2, Eye Dam. 1, Acute Tox. 3 (Inhalation), Acute Tox. 3 (Oral), Aquatic Acute 1, Aquatic Chronic 1, Skin Sens. 1B	Not listed	Listed	Listed (Cancer)		
Polymerized 2,2,4-trimethyl-1,2-dihydroquinoline (TMQ)	26780-96-1	CC1=CC(NC2=CC=CC=C12)(C)C	ECHA dossier contains no information on transformation products										Not listed	Not listed	Not listed
N,N'-Bis(1,4-dimethylpentyl)-p-phenylenediamine (77PD)	3081-14-9	CC(C)CCC(C)NC1=CC=C(C=C1)NC(C)CCC(C)C	Quinone-diimine	CAS not identified	NA	Unable to assess due to lack of CAS			CAS not identified	CAS not identified					
			N-1,4 Dimethyl-pentyl-p-phenol (4PD-OH)	CAS not identified	NA	Unable to assess due to lack of CAS			CAS not identified	CAS not identified					
			1,4-Dimethylpentylamine	28292-43-5	CC(C)CCC(C)N	-	-	-	-	No ECHA dossier	Not listed	Not listed	Not listed		
			p-Benzoquinone	106-51-4	C1=CC(=O)C=CC1=O	Between 0.1 and 0.3 (at 23°C)	No information in ECHA dossier	2.93E-02	1.47E+04 (at 20°C)	Acute Tox. 3 (Oral), Aquatic Acute 1, Skin Irrit. 2, Eye Irrit. 2, STOT SE 3, Acute Tox. 3 (Inhalation), Aquatic Chronic 1, Muta. 2, Skin Sens. 1, Flam. Sol. 1	Not listed	Listed	Not listed		
p-Hydroquinone	123-31-9	C1=CC(=CC=C1O)O	0.59 (at 20°C)	1.585	2.40E-05	7.20E+04 (at 25°C)	Aquatic Acute 1, Carc. 2, Muta. 2, Eye Dam. 1, Acute Tox. 4 (Oral), Skin Sens. 1, Aquatic Chronic 1, Skin Sens. 1B	Not listed	Listed	Not listed					
4,4'-Dioctyldiphenylamine (DOPD)	101-67-7	CCCCCCCCC1=CC=C(C=C1)NC2=CC=C(C=C2)CCCCCCCC	No ECHA dossier available to support evaluation.										Not listed	Not listed	Not listed
N,N'-Ditoyl-p-phenylenediamine (Commercial DTPD)	68953-84-4	CC1=CC=C(C=C1)NC2=CC(=CC=C2)NC3=CC=C(C=C3)C	Hydroxydiphenylamine	122-37-2 (most likely)	C1=CC=C(C=C1)NC2=CC=C(C=C2)O	2.82 (From EPISUITE. Hansch, C <i>et al.</i> (1995))	No information in ECHA dossier			No useful information in ECHA dossier	Not listed	Not listed	Not listed		
			Methyl hydroxydiphenylamine	CAS not identified	NA	Unable to assess due to lack of CAS			CAS not identified	CAS not identified					
N,N'-Dicyclohexyl-p-phenylenediamine (CCPD)	4175-38-6	C1CCC(CC1)NC2=CC=C(C=C2)NC3CCCCC3	No ECHA dossier available to support evaluation.										Not listed	Not listed	Not listed
Diaryl-p-phenylene diamine (DAPD)	68953-84-4	CC1=CC=C(C=C1)NC2=CC(=CC=C2)NC3=CC=C(C=C3)C	Hydroxydiphenylamine	122-37-2 (most likely)	C1=CC=C(C=C1)NC2=CC=C(C=C2)O	2.82 (From EPISUITE. Hansch, C <i>et al.</i> (1995))	No information in ECHA dossier			No useful information in ECHA dossier	Not listed	Not listed	Not listed		
			Methyl hydroxydiphenylamine	CAS not identified	NA	Unable to assess due to lack of CAS			CAS not identified	CAS not identified					
N,N'-Di-2-naphthyl-p-phenylenediamine (DNPPDA)	93-46-9	C1=CC=C2C=C(C=CC2=C1)NC3=CC=C(C=C3)NC4=CC5=CC=CC=C5C4	No ECHA dossier available to support evaluation.										Not listed	Not listed	Not listed
Nickel dibutylthiocarbamate (NBC)	13927-77-0	CCCCN(CCCC)C(=S)[S-].CCCCN(CCCC)C(=S)[S-].[Ni+2]	ECHA dossier contains no information on transformation products.										Not listed	Not listed	Not listed
Ethoxyquin	91-53-2	CCOC1=CC2=C(C=C1)NC(C=C2)C(C)C	ECHA dossier contains no information on transformation products.										Not listed	Not listed	Not listed
Dilauryl thiodipropionate	123-28-4	O=C(OCCCCCCCCCCC)CCSCC(=O)OCCCCCCCCCCC	ECHA dossier contains no information on transformation products.										Not listed	Not listed	Not listed
N'-Phenyl-N-Fluorenyl-Para-Phenylenediamine	No CAS	C1=C(NC(C=CC2)=CC=2)C=CC(C=C1)NC(C(C1=CC2)=CC=2)C(=CC=C2)C1=C2	No ECHA dossier available to support evaluation.										Not listed	Not listed	Not listed
N-(p-phenylthiomethylphenyl)-N'-(1,3 dimethyl-butyl)-p-phenylenediamine	No CAS	CC(C)CC(C)NC1=CC=C(C=C1)NC2=CC=C(C=C2)CSC3=CC=CC=C3	No ECHA dossier available to support evaluation.										Not listed	Not listed	Not listed
4-(2,5-dimethyl-1H-pyrrol-1-yl)-N-phenylaniline	No CAS	CC1=CC=C(N1C2=CC=C(C=C2)NC3=CC=CC=C3)C	No ECHA dossier available to support evaluation.										Not listed	Not listed	Not listed
N,N - (ethane-1,2-diyl) bis (N-phenylbenzene-1 4-diamine or similar chemical 1-N-[2-(4-anilinoanilino)ethyl]-4-N-phenylbenzene-1,4-diamine	No CAS	C1=CC=C(C=C1)NC2=CC=C(C=C2)NCCNC3=CC=C(C=C3)NC4=CC=CC=C4	No ECHA dossier available to support evaluation.										Not listed	Not listed	Not listed

Chemical Name	CAS No.	SMILES	Transformation Product Name	Transformation Product CAS	Transformation Product SMILES	log K _{ow}	log K _{oc}	VP (saturated mm Hg at 25°C)	Water Solubility (mg/L)	ECHA Dossier GHS Conclusion	EU Persistent Bioaccumulative and Toxic	California Toxic Air Contaminant	California Proposition 65
4-N-(2,3-dimethylphenyl)-1-N-phenylbenzene-1,4-diamine-R1 and R2 are methyl	No CAS	CC1=C(C(=CC=C1)NC2=CC=C(C=C2)NC3=CC=CC=C3)C								No ECHA dossier available to support evaluation.	Not listed	Not listed	Not listed
RU997 Irgazone 997 Reaction product of N-phenyl-N'-(1,3dimethylbutyl)-p-phenylenediamine with an alkyl glycidylthioether.	444992-04-5	C1=CC(=CC=C1)NC1C=CC(=CC=1)N(CC(O)CSC(C)(C)CCC(C)C(C)C)C								No ECHA dossier available to support evaluation.	Not listed	Not listed	Not listed
4-[4-(4-Methylpentan-2-ylamino)anilino]phenol	No CAS	CC(C)CC(C)NC1=CC=C(C=C1)NC2=CC=C(C=C2)O								No ECHA dossier available to support evaluation.	Not listed	Not listed	Not listed
This is a class of compounds. Reference uses case where R1 and R2 are methyl; n,p and q are zero and m=1 and is in the para position. Representative example from class (4-((4-(dimethylamino)phenyl)amino)phenol)	6358-22-1	CN(C)C1=CC=C(C=C1)NC2=CC=C(C=C2)O								No ECHA dossier available to support evaluation.	Not listed	Not listed	Not listed
N,N-diethyl-2,2,4-trimethyl-1H-quinolin-6-amine (R=N(C2H5)2)	No CAS	CCN(CC)C1=CC2=C(C=C1)NC(C=C2)(C)C								No ECHA dossier available to support evaluation.	Not listed	Not listed	Not listed
Mixed xylene diamines N,N'-Dibenzyl-p-xylene-alpha,alpha'-diamine-	25790-41-4	Mixture								No ECHA dossier available to support evaluation.	Not listed	Not listed	Not listed
2,4,6-tris-(N-1,4-dimethylpentyl-para-phenylenediamino)-1,3,5-triazine, TAPDT	121246-28-4	CC(C)CCC(C)NC1=CC=C(C=C1)NC2=NC(=NC(=N2)NC3=CC=C(C=C3)NC(C)CCC(C)C)NC4=CC=C(C=C4)NC(C)CCC(C)C								ECHA dossier contains no information on transformation products.	Not listed	Not listed	Not listed
N-Phenyl-1-naphthylamine	90-30-2	C1=CC=C(C=C1)NC2=CC=CC3=CC=CC=C32								ECHA dossier contains no information on transformation products.	Not listed	Not listed	Not listed
N-Phenyl-2-naphthylamine	135-88-6	C1=CC=C(C=C1)NC2=CC3=CC=CC=C3C=C2								ECHA dossier contains no information on transformation products.	Not listed	Not listed	Not listed
Irganox 1520	110553-27-0	CCCCCCCCC1=CC=C(C=C1)C)O)CSCCCCCC								ECHA dossier contains no information on transformation products.	Not listed	Not listed	Not listed
Graphene	1034343-98-0	[C]								ECHA dossier contains no information on transformation products.	Not listed	Not listed	Not listed
1,1'-Pentamethylenebis(2,2-Di-n-Butylhydrazine)	No CAS	CCCCN(CCCC)NCCCCN(CCCC)CCCC								No ECHA dossier available to support evaluation.	Not listed	Not listed	Not listed
α-C-4-hydroxy-3,5-dimethylphenyl (Lowinox WSP). No number for nitron - N-isopropyl nitron and Lowinox WSP	Lowinox WSP - 77-62-3, No CAS for nitron	Mixture								No ECHA dossier available to support evaluation.	Not listed	Not listed	Not listed
N-(4-methylpentan-2-yl)-10H-phenothiazin-3-amine	No CAS	CC(C)CC(C)NC1=CC2=C(C=C1)NC3=CC=CC=C3S2								No ECHA dossier available to support evaluation.	Not listed	Not listed	Not listed
7-(4-methylpentan-2-ylamino)-2,3,4,10-tetrahydro-1H-acridin-9-one	No CAS	CC(C)CC(C)NC1=CC2=C(C=C1)NC3=C(C2=O)CCCC3								No ECHA dossier available to support evaluation.	Not listed	Not listed	Not listed
2-cyclohexyl-N-(4-methylpentan-2-yl)-1H-indol-5-amine	No CAS	CC(C)CC(C)NC1=CC2=C(C=C1)NC(=C2)C3CCCC3								No ECHA dossier available to support evaluation.	Not listed	Not listed	Not listed
4-(1H-indol-2-yl)-N-(4-methylpentan-2-yl)aniline	No CAS	CC(C)CC(C)NC1=CC=C(C=C1)C2=CC3=CC=CC=C3N2								No ECHA dossier available to support evaluation.	Not listed	Not listed	Not listed
α-C-4-Hydroxy-3,5-dimethylphenyl-N-tert. butyl nitron	No CAS	NA								No ECHA dossier available to support evaluation.	Not listed	Not listed	Not listed
Amine functionalized lignin	No CAS	NA								No ECHA dossier available to support evaluation.	Not listed	Not listed	Not listed

Chemical Name	CAS No.	SMILES	Transformation Product Name	Transformation Product CAS	Transformation Product SMILES	log K _{ow}	log K _{oc}	VP (saturated mm Hg at 25°C)	Water Solubility (mg/L)	ECHA Dossier GHS Conclusion	EU Persistent Bioaccumulative and Toxic	California Toxic Air Contaminant	California Proposition 65
Rambutan peel extract	No CAS	NA								No ECHA dossier available to support evaluation.	Not listed	Not listed	Not listed
Nano Calcium Carbonate Surface Modified by Gallic Acid	No CAS	NA								No ECHA dossier available to support evaluation.	Not listed	Not listed	Not listed
Octyl Gallate	1034-01-1	CCCCCCCCOC(=O)C1=CC(=C(C(=C1)O)O)O								No ECHA dossier available to support evaluation.	Not listed	Not listed	Not listed
8PPD	15233-47-3	CCCCCCC(C)NC1=CC=C(C=C1)NC2=CC=CC=C2								No ECHA dossier available to support evaluation.	Not listed	Not listed	Not listed
Specialized carbon nanotube mixture	No CAS	NA								No ECHA dossier available to support evaluation.	Not listed	Not listed	Not listed

Notes:

Orange shading indicates a breakdown product of potential concern.

CAS No. = Chemical Abstracts Service Number; ECHA = European Chemicals Agency; GHS = Globally Harmonized System of Classification and Labelling of Chemicals; EU = European Union; K_{oc} = Log Organic Carbon Partition Coefficient; K_{ow} = Log Octanol-Water Partition Coefficient; NA = Not Available; SMILES = Simplified Molecular-Input Line-Entry System; VP = Vapor Pressure.

Table 5.15 Stage 1 Alternatives Analysis Report Conclusions Based on Available Data

Chemical	CAS	Human Health Score	Environmental Score	Physical Score	Total Score	Salmonid Toxicity Parent (ug/L)	Salmonid Toxicity Quinone/O ₃ reaction product (ug/L)	Ingredient Exposure Potential (Table 5.9)	Summary of Existing Performance Data (Tables 5.11-5.13)	Conclusions
		(Table 5.1)	(Table 5.3)	(Table 5.3)	(Table 5.8)	(Table 5.4)	(Table 5.4)			
N-(1,3-dimethylbutyl)-N'-phenyl-p-phenylenediamine (6PPD)	793-24-8	125	150	0	275	140 (96 hr)	0.041 (24 hr)	-	NA	Candidate chemical in priority product
Possible Alternatives										
N-(1,4-dimethylpentyl)-N'-phenyl-p-phenylenediamine (7PPD)	3081-01-4	120	150	0	270	No data	No data	Similar environmental partitioning	Some promising performance data (Tables 5.11 and 5.12)	Include in Stage 2. Has hazard data and some promising performance data
N-isopropyl-N'-phenyl-p-phenylenediamine (IPPD)	101-72-4	150	100	0	250	No data	>50 (96 hr)	Slightly more likely to migrate in water	Some promising performance data (Tables 5.11)	Include in Stage 2. Has hazard data and some promising performance data
N-cyclohexyl-N'-phenyl-p-phenylenediamine (CPPD)	101-87-1	Not assigned based on complete data gap	Not assigned based on complete data gap	Not assigned based on complete data gap	Not assigned based on complete data gap	No data	>50 (96 hr)	Slightly more likely to migrate in water	Limited data as an antiozonant (Table 5.11)	Drop from Stage 2. Complete data gap regarding hazards
N,N'-diphenyl-p-phenylenediamine (DPPD)	74-31-7	80	150	0	230	No data	>50 (96 hr)	Similar environmental partitioning	Poor performance (Table 5.12)	Drop from Stage 2 due to poor performance data
N-1,3-dimethyl butyl-N'-phenyl quinone diimine (6QDI)	52870-46-9	175	150	0	325	638 (96 hr)	No data	Substantially less water soluble and more fat soluble	Releases 6PPD when mixed in rubber (Table 5.11)	Drop from Stage 2. Releases 6PPD when mixed in rubber. Worse human health score than 6PPD
Polymerized 2,2,4-trimethyl-1,2-dihydroquinoline (TMQ)	26780-96-1	170	70	0	240	No data	No data	Similar environmental partitioning	Poor performance (Table 5.11)	Drop from Stage 2 due to poor performance data, worse human health score than 6PPD
N,N'-Bis(1,4-dimethylpentyl)-p-phenylenediamine (77PD)	3081-14-9	80	100	0	180	24 (96 hr)	>226 (96 hr)	Similar environmental partitioning	Some promising performance data (Tables 5.12)	Include in Stage 2. Has hazard data and some promising performance data
4,4'-Dioclyldiphenylamine (DOPD)	101-67-7	Not assigned based on complete data gap	Not assigned based on complete data gap	Not assigned based on complete data gap	Not assigned based on complete data gap	No data	No data	Much less volatile and water soluble, much more carbon and fat soluble.	Limited data as an antiozonant (Table 5.11)	Drop from Stage 2. Complete data gap regarding hazards
N,N'-Ditolyl-p-phenylenediamine (Commercial DTPD)	68953-84-4	55	150	0	205	480 (96 hr)	>50 (96 hr)	Similar environmental partitioning	Poor performance (Table 5.12)	Drop from Stage 2 due to poor performance data
N,N'-Dicyclohexyl-p-phenylenediamine (CCPD)	4175-38-6	115	150	0	265	No data	No data	Similar environmental partitioning	Some promising performance data (Tables 5.12)	Include in Stage 2. Has hazard data and some promising performance data
Diaryl-p-phenylene diamine (DAPD)	68953-84-4	55	150	0	205	>480 (96 hr)	No data	Similar environmental partitioning	Poor performance (Table 5.12)	Drop from Stage 2 due to poor performance data
N,N'-Di-2-naphthyl-p-phenylenediamine (DNPDA)	93-46-9	Not assigned based on complete data gap	Not assigned based on complete data gap	Not assigned based on complete data gap	Not assigned based on complete data gap	No data	No data	Much less volatile and water soluble, much more carbon and fat soluble.	Insufficient data, no ozone data (Table 5.11)	Drop from Stage 2. Complete data gap regarding hazards and no ozone data
Nickel dibutyldithiocarbamate (NBC)	13927-77-0	170	50	0	220	>100,000 (96 hr)	No data	Similar environmental partitioning	Poor performance (Table 5.11)	Drop from Stage 2 due to poor performance data, worse human health score than 6PPD
Ethoxyquin	91-53-2	135	70	0	205	18,000 (96 hr)	No data	More water soluble, higher vapor pressure and lower carbon and fat solubility	Poor performance (Table 5.11)	Drop from Stage 2 due to poor performance data
Dilauryl thiodipropionate	123-28-4	40	0	0	40	No data	No data	Less water soluble, low vapor pressure and more carbon and fat soluble	Insufficient data, no ozone data (Table 5.11)	Drop from Stage 2. No ozone data
N'-Phenyl-N-Fluorenyl-Para-Phenylenediamine	No CAS	Not assigned based on complete data gap	Not assigned based on complete data gap	Not assigned based on complete data gap	Not assigned based on complete data gap	No data	No data	Less water soluble, low vapor pressure and more carbon and fat soluble	Some promising performance data (Tables 5.11)	Drop from Stage 2. Complete data gap regarding hazards
N-(p-phenylthiomethylphenyl)-N'-(1,3 dimethyl-butyl)-p-phenylenediamine	No CAS	Not assigned based on complete data gap	Not assigned based on complete data gap	Not assigned based on complete data gap	Not assigned based on complete data gap	No data	No data	Less water soluble, low vapor pressure and more carbon and fat soluble	Limited data as an antiozonant (Table 5.11)	Drop from Stage 2. Complete data gap regarding hazards

Chemical	CAS					Salmonid Toxicity Parent (ug/L) (Table 5.4)	Salmonid Toxicity Quinone/O ₃ reaction product (ug/L) (Table 5.4)	Ingredient Exposure Potential (Table 5.9)	Summary of Existing Performance Data (Tables 5.11-5.13)	Conclusions
		Human Health Score (Table 5.1)	Environmental Score (Table 5.3)	Physical Score (Table 5.3)	Total Score (Table 5.8)					
4-(2,5-dimethyl-1H-pyrrol-1-yl)-N-phenylaniline	No CAS	Not assigned based on complete data gap	Not assigned based on complete data gap	Not assigned based on complete data gap	Not assigned based on complete data gap	No data	No data	Similar environmental partitioning	Poor performance (Table 5.11)	Drop from Stage 2. Complete data gap regarding hazards and poor performance
N,N - (ethane-1,2-diyl) bis (N-phenylbenzene-1,4-diamine [example chemical from patent])	No CAS	Not assigned based on complete data gap	Not assigned based on complete data gap	Not assigned based on complete data gap	Not assigned based on complete data gap	No data	No data	More carbon soluble, lower vapor pressure, less water soluble	Some promising performance data (Tables 5.13)	Drop from Stage 2. Complete data gap regarding hazards
4-N-(2,3-dimethylphenyl)-1-N-phenylbenzene-1,4-diamine- R1 and R2 are methyl	No CAS	Not assigned based on complete data gap	Not assigned based on complete data gap	Not assigned based on complete data gap	Not assigned based on complete data gap	No data	No data	Similar environmental partitioning	Insufficient data, no ozone data (Table 5.11)	Drop from Stage 2. Complete data gap regarding hazards and no ozone data
RU997, Irgazone 997 (Reaction product of N-phenyl-N'-(1,3dimethylbutyl)-p-phenylenediamine with an alkyl glycidylthioether)	444992-04-5	130	65	0	195	No data	No data	Less water soluble, low vapor pressure and more carbon and fat soluble	Insufficient data, no ozone data and shown to migrate too fast (Table 5.11)	Drop from Stage 2. No ozone data
4-[4-(4-Methylpentan-2-ylamino)anilino]phenol	No CAS	Not assigned based on complete data gap	Not assigned based on complete data gap	Not assigned based on complete data gap	Not assigned based on complete data gap	No data	No data	Similar environmental partitioning	Some promising performance data (Tables 5.13)	Drop from Stage 2. Complete data gap regarding hazards
Representative example from class 4-((4-(dimethylamino)phenyl)amino)phenol)	6358-22-1	Not assigned based on complete data gap	Not assigned based on complete data gap	Not assigned based on complete data gap	Not assigned based on complete data gap	No data	No data	Similar environmental partitioning	Some promising performance data (Tables 5.13)	Drop from Stage 2. Complete data gap regarding hazards
N,N-diethyl-2,2,4-trimethyl-1H-quinolin-6-amine (R= N(C ₂ H ₅) ₂)	No CAS	Not assigned based on complete data gap	Not assigned based on complete data gap	Not assigned based on complete data gap	Not assigned based on complete data gap	No data	No data	Similar environmental partitioning	Some promising performance data (Tables 5.11)	Drop from Stage 2. Complete data gap regarding hazards
N,N'-Dibenzyl-p-xylene-alpha,alpha'-diamine-	25790-41-4	Not assigned based on complete data gap	Not assigned based on complete data gap	Not assigned based on complete data gap	Not assigned based on complete data gap	No data	No data	Mixture, properties undetermined	Some promising performance data (Tables 5.11)	Drop from Stage 2. Complete data gap regarding hazards
2,4,6-tris-(N-1,4-dimethylpentyl-para-phenylenediamino)-1,3,5 triazine (Durazone 37 or TAPDT)	121246-28-4	50	100	0	150	No data	No data	Far less water soluble and lower vapor pressure and much more carbon and fat soluble	Poor performance (Table 5.11)	Drop from Stage 2 due to poor performance data
N-Phenyl-1-naphthylamine	90-30-2	45	150	0	195	440 (96 hr)	No data	Similar environmental partitioning	Poor performance (Table 5.11)	Drop from Stage 2 due to poor performance data
N-Phenyl-2-naphthylamine	135-88-6	180	20	0	200	No data	No data	Similar environmental partitioning	Insufficient data, no ozone data (Table 5.11)	Drop from Stage 2. No ozone data and worse human health score than 6PPD
[2-Methyl-4,6-bis((octylthio)methyl)phenol (Irganox 1520 CAS 110553-27-0)	110553-27-0	30	10	0	40	No data	No data	Less water soluble, low vapor pressure and more carbon and fat soluble	Limited data as an antiozonant (Table 5.11)	Include in Stage 2. Has hazard data and limited performance data as an antiozonant
Specialized graphene (e.g., Prophene™)	1034343-98-0	55	85	0	140	No data	No data	Organic carbon material, negligible vapor pressure (but may be suspended in air), similar water solubility	Some promising performance data (Tables 5.13)	Include in Stage 2. Has hazard data and some promising performance data
1,1' -Pentamethylenebis(2,2-Di-n- Butylhydrazine)	No CAS	Not assigned based on complete data gap	Not assigned based on complete data gap	Not assigned based on complete data gap	Not assigned based on complete data gap	No data	No data	Similar vapor pressure and carbon/fat solubility, greater water solubility	Limited data as an antiozonant (Table 5.11)	Drop from Stage 2. Complete data gap regarding hazards
α- C-4- hydroxy- 3,5-dimethylphenyl - N-isopropyl and Lowinox WSP CAS 77-62-3	Nitrone as a class, no CAS and Lowinox WSP - 77-62-3	5 (for Lowinox WSP, however, no information on nitrone as a class)	0 (for Lowinox WSP, however, no information on nitrone as a class)	0 (for Lowinox WSP, however, no information on nitrone as a class)	Not assigned based on lack of data for nitrone as a class	No data	No data	Mixture, properties for nitrone undetermined due to no CAS	Some promising performance data (Tables 5.11)	Drop from Stage 2. Complete data gap regarding hazards
N-(4-methylpentan-2-yl)-10H-phenothiazin-3-amine	No CAS	Not assigned based on complete data gap	Not assigned based on complete data gap	Not assigned based on complete data gap	Not assigned based on complete data gap	No data	No data	Similar environmental partitioning	Some promising calculations (Tables 5.13)	Drop from Stage 2. Complete data gap regarding hazards

Chemical	CAS					Salmonid Toxicity Parent (ug/L) (Table 5.4)	Salmonid Toxicity Quinone/O ₃ reaction product (ug/L) (Table 5.4)	Ingredient Exposure Potential (Table 5.9)	Summary of Existing Performance Data (Tables 5.11-5.13)	Conclusions
		Human Health Score (Table 5.1)	Environmental Score (Table 5.3)	Physical Score (Table 5.3)	Total Score (Table 5.8)					
7-(4-methylpentan-2-ylamino)-2,3,4,10-tetrahydro-1H-acridin-9-one	No CAS	Not assigned based on complete data gap	Not assigned based on complete data gap	Not assigned based on complete data gap	Not assigned based on complete data gap	No data	No data	Greater lipid solubility, similar vapor pressure, lower water solubility	Insufficient data, no ozone data (Table 5.13)	Drop from Stage 2. Complete data gap regarding hazards and no ozone data
2-cyclohexyl-N-(4-methylpentan-2-yl)-1H-indol-5-amine	No CAS	Not assigned based on complete data gap	Not assigned based on complete data gap	Not assigned based on complete data gap	Not assigned based on complete data gap	No data	No data	Greater lipid solubility, similar vapor pressure, lower water solubility	Insufficient data, no ozone data (Table 5.13)	Drop from Stage 2. Complete data gap regarding hazards and no ozone data
4-(1H-indol-2-yl)-N-(4-methylpentan-2-yl)aniline	No CAS	Not assigned based on complete data gap	Not assigned based on complete data gap	Not assigned based on complete data gap	Not assigned based on complete data gap	No data	No data	Greater lipid solubility, similar vapor pressure, lower water solubility	Insufficient data, no ozone data (Table 5.13)	Drop from Stage 2. Complete data gap regarding hazards and no ozone data
α-C-4-Hydroxy-3,5-dimethylphenyl-N-tert. butyl nitrene	No CAS	Not assigned based on complete data gap	Not assigned based on complete data gap	Not assigned based on complete data gap	Not assigned based on complete data gap	No data	No data	Similar environmental partitioning	Some promising performance data (Tables 5.11)	Drop from Stage 2. Complete data gap regarding hazards
Amine functionalized lignin	No CAS	Not assigned based on complete data gap	Not assigned based on complete data gap	Not assigned based on complete data gap	Not assigned based on complete data gap	No data	No data	Polymer, properties undetermined	Some promising performance data (Tables 5.13)	Drop from Stage 2. Complete data gap regarding hazards
Rambutan peel extract	No CAS	Not assigned based on complete data gap	Not assigned based on complete data gap	Not assigned based on complete data gap	Not assigned based on complete data gap	No data	No data	Complex mixture, properties undetermined	Some promising performance data (Tables 5.13)	Drop from Stage 2. Complete data gap regarding hazards
Octyl gallate	1034-01-1	40	100	0	140	No data	No data	Similar environmental partitioning	Limited data as an antiozonant (Table 5.11)	Include in Stage 2. Has hazard data and limited performance data as an antiozonant
Nano calcium carbonate surface modified by gallic acid	No CAS	Not assigned based on complete data gap	Not assigned based on complete data gap	Not assigned based on complete data gap	Not assigned based on complete data gap	No data	No data	Complex chemical, properties undetermined	Some promising performance data (Tables 5.11)	Drop from Stage 2. Complete data gap regarding hazards
N-1-Methylheptyl-N'-phenyl-p-phenylenediamine (8PPD or UOP 688)	15233-47-3	Not assigned based on complete data gap	Not assigned based on complete data gap	Not assigned based on complete data gap	Not assigned based on complete data gap	No data	No data	Similar environmental partitioning	Limited data as an antiozonant (Table 5.11)	Drop from Stage 2. Complete data gap regarding hazards
Specialized carbon nanotube mixtures	No CAS	Not assigned based on complete data gap	Not assigned based on complete data gap	Not assigned based on complete data gap	Not assigned based on complete data gap	No data	No data	Complex chemical, properties undetermined	Some promising performance data (Tables 5.13)	Drop from Stage 2. Complete data gap regarding hazards

Notes:

CAS = Chemical Abstracts Service Number; NA = Not Available; O₃ = Ozone.

Legend:

	Substantially Higher than Priority Products
	Less desirable than Priority Product (for CSI score, worse by more than 30%)
	Similar to Priority Products
	Lower than Priority Products
	More desirable than Priority Product (for CSI score, better by more than 30%)
	Not Applicable: No Comparison Data Available
	Higher and Lower than Priority Products

Motor Vehicle Tires Containing 6PPD

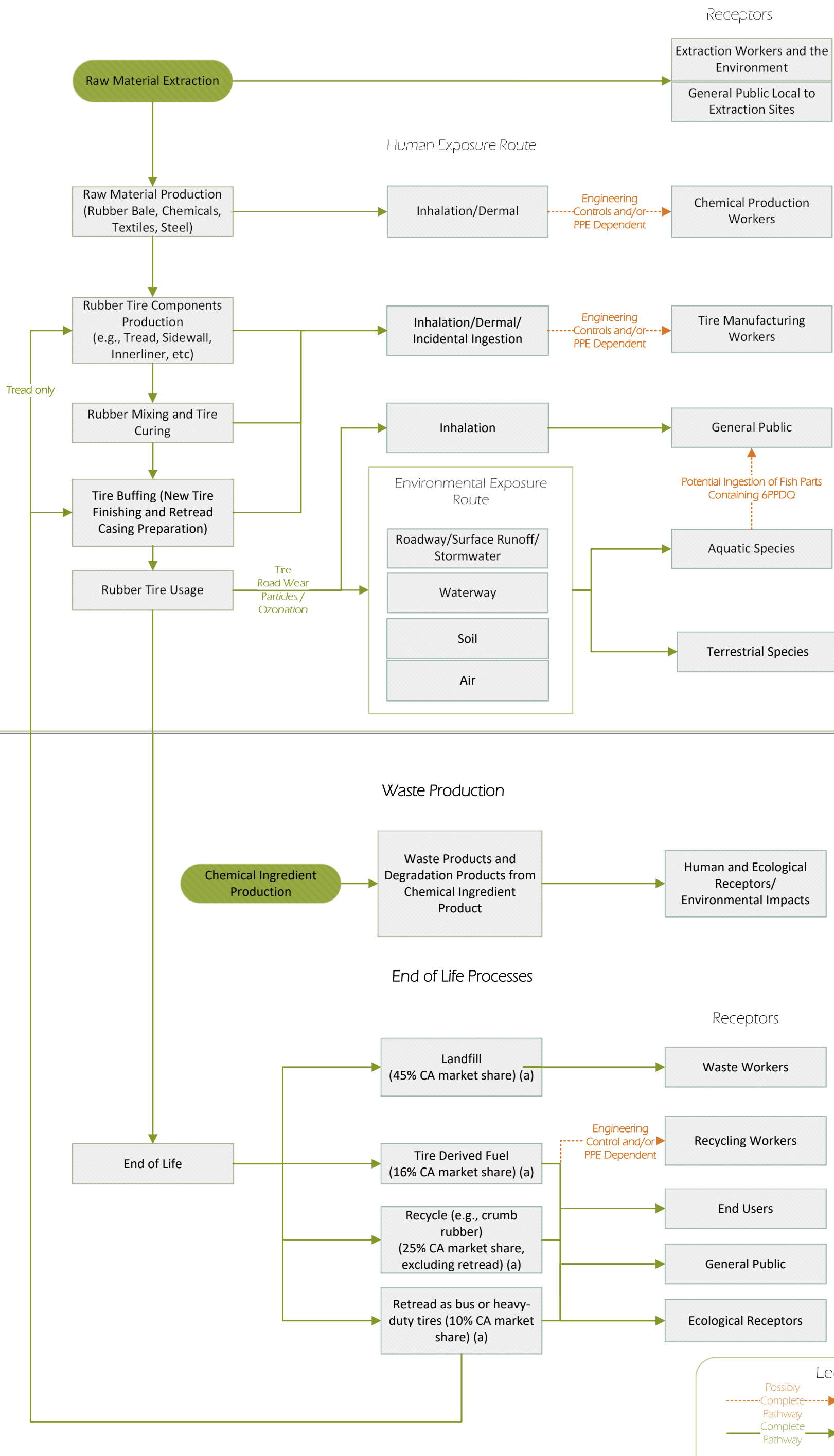

Figure 4.2 Conceptual Exposure Model: Motor Vehicle Tires Containing 6PPD

(a) Of the 35% of recycled tires in California, 13% are recycled as crumb rubber, 10% are retreaded as tires for buses and heavy-duty trucks, 8% are sold as used tires, 1% are used as tire-derived aggregate, and 3% are recycled via other means. Source: CalRecycle, 2023

Motor Vehicle Tires Containing Possible Alternatives to 6PPD

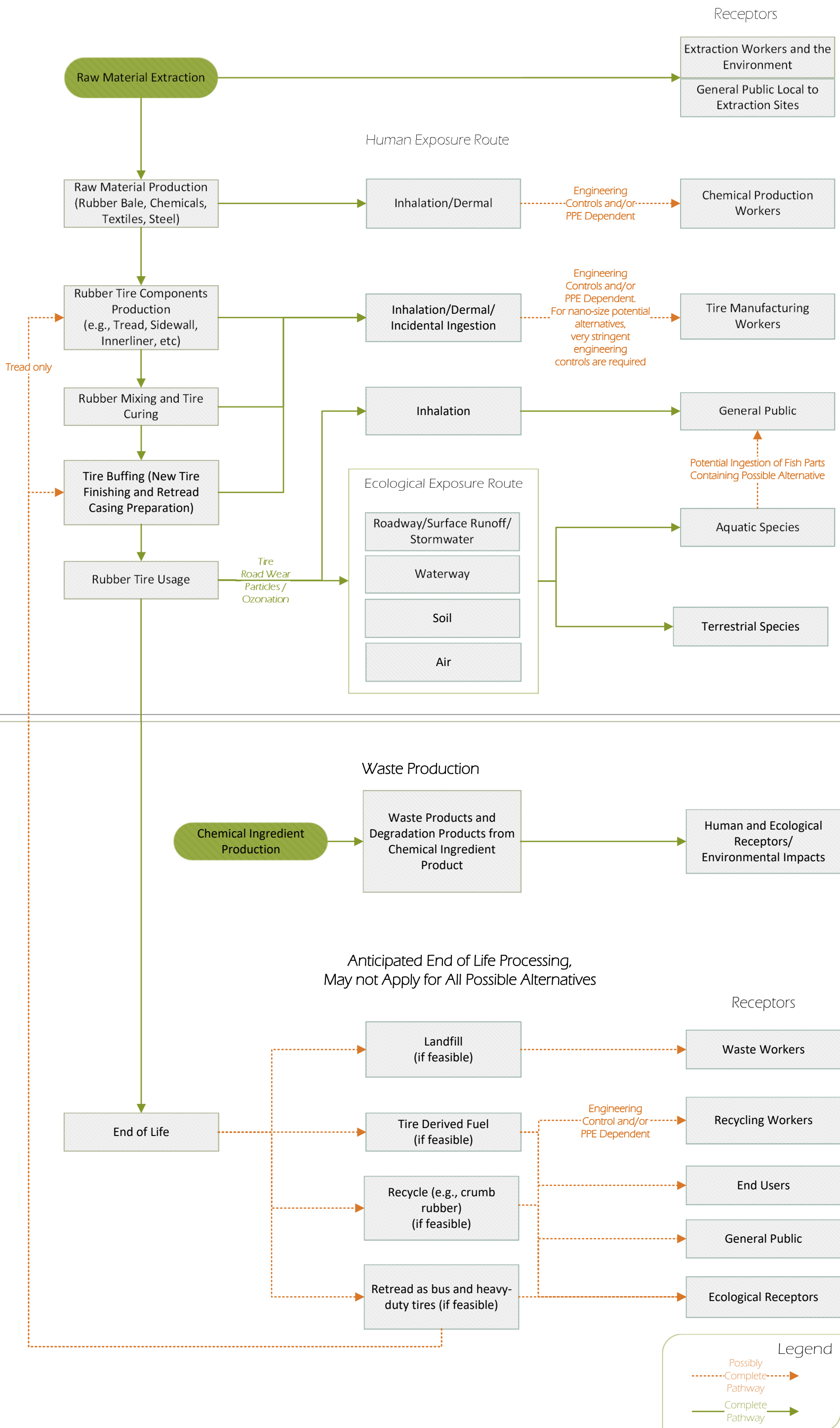

Figure 4.3 Conceptual Exposure Model: Motor Vehicle Tires Containing Possible Alternatives to 6PPD

Appendix A

Glossary of Tire Related Terms

Antidegradant: Antidegradants are added to rubber compounds to protect tires from overly rapid deterioration by ozone, oxygen, fatigue, and heat. Antidegradants include both antioxidants and antiozonants. Antidegradants in tires must serve in two load performance conditions – static and dynamic operations modes - which describe when the tire is at rest or flexing under motion, respectively.

Antioxidant: A compound that helps to keep rubber from breaking down due to the effects of temperature and oxygen exposure.

Antiozonant: A compound that impedes the effects of exposure to ozone on the surface of the tire.

Bead: The tire bead is the portion (or component) of the tire that sits on the rim of the wheel. Tire beads are steel wire bundles that are coated with a specific rubber compound and secure the tire to the metal wheel.

Bead Filler: A rubber compound placed above the bead that may be used between the body plies, which wrap around the bead to enhance ride and handling characteristics.

Belts: Belts provide stability to the tread area of the tire, which minimizes wear and contributes to vehicle handling and traction. Typically, two belts with steel cords laid at opposing angles form a hoop under a tire's tread. The steel belt is coated with a rubber compound that is called a belt coat or belt skim compound.

Body Plies: Body plies function as the base structure of the tire and provide the strength to contain the inflation pressure. Most car tires have one or two body plies, each typically comprised of textile cords within a rubber layer. Truck and bus tires typically use steel cords for body plies.

Curing Systems: Sulfur, chemical accelerators (often derivatives of benzothiazole), stearic acid, and zinc oxide are crucial ingredients for vulcanization, which transforms soft uncured rubber into a solid elastic article during tire curing. Curing systems not only enable vulcanization, but also shorten the vulcanization time and impact the length and number of crosslinks in the rubber matrix which, in turn, affects the rubber's properties.

Dynamic Load Performance: Antioxidants and antiozonants with dynamic operation modes protect the tire while it is in motion and being flexed.

Endurance: Tire endurance is a measurement of how long a tire can withstand severe conditions before reaching its limit. Endurance can be tested by varying the speed, load, inflation pressure, temperature, and/or number of cycles.

Field Testing: Tire manufacturers may conduct field testing to obtain performance data for tires operated under real-life conditions for an extended period of time. Field testing is typically performed by a contracted fleet with routine monitoring by the tire manufacturer.

Fillers: Multiple grades of carbon black and coupled/uncoupled precipitated amorphous silica are used as fillers to reinforce the rubber and modify its properties, resulting in improved wear performance and traction.

Gravel Chip/Tear: For passenger and light truck tires that are intended to be driven off road, an evaluation is conducted on a vehicle on a gravel route to assess chipping and tearing of tread elements.

Handling: Handling is a result of tire/vehicle interactions in response to various driver inputs.

Inner Liner: A rubber compound used to retain the inflation pressure inside the tire.

Irregular Wear: Uneven or abnormal wear features observed during a wear test.

Natural Rubber: Natural rubber provides specific performance characteristics to tires, such as tear and fatigue crack resistance. Some tires, especially truck and bus tires, use natural rubber in tread compounds to provide reduced rolling resistance (the resistance the tire encounters when rolling down the road – an important consideration for fuel efficiency). Natural rubber is a form of polyisoprene which is obtained by tapping rubber trees (*Hevea brasiliensis*).

Non-Pneumatic Tire: A type of tire that is airless.

Original Equipment (OE): Equipment supplied on a vehicle at its time of purchase.

Original Equipment Manufacturer (OEM): Manufacturer of original equipment (OE) supplied on a vehicle at its time of purchase.

Original Equipment Tires (OE Tires): OE tires must meet specific, often numerous and complex performance requirements specific to the vehicle manufacturer. OE tires are designed to a specific vehicle model year/make/model/trim level combination, and any changes to the materials used to manufacture OE tires, or the tire design itself, would require approval from the vehicle manufacturer. While tires installed on new vehicles are not part of the Priority Product definition, OE tires are also considered replacement tires due to requirements in OE contracts for OE tires to be available as replacements, customer demand for OE tires in the replacement market, and to manage excess OE tire inventory. OE tires typically do not come with treadwear warranties. For purposes of this Stage 1 AA, OE tires are considered to be a subset of the replacement tire market and included in the analyses.

Pneumatic Tire: A type of tire that is filled with air.

Processing Aids: Bio-based oils, low aromatic petroleum oils, pine tar, and resins are the most common softening agents used in rubber compounding. Tackifying resins can be added to increase the rubber compound stickiness (tack), which helps the various tire components stick together assembly of tire components.

Replacement Tires: Tires designed for the replacement market to perform well on a wide range of vehicles – often as many as 30 different vehicle applications are appropriate for a single tire service description (tire size/speed rating/load index combination). Passenger and light truck replacement tires can be installed by a tire dealer or other tire service professional without original equipment manufacturer (OEM) approval.

Rolling Resistance: The force necessary to keep a tire rolling.

Rolling Resistance Coefficient (RRC): Rolling resistance is measured according to ISO 28580:2018 and is expressed in terms of rolling resistance coefficient (RRC). To measure rolling resistance, a load is placed on the tire while it is being forced to turn by the drum and the resistance force, which the tire generates to prevent it from turning, is measured.

Sidewall: A rubber compound used to cover the body plies on the sides of the tire, which provides abrasion, scuff, and weathering resistance.

Static Load Performance: Antioxidants and antiozonants with static operation modes form a coating that protect the tire when it is in its resting and stationary state.

Synthetic Polymers: The two main synthetic rubber polymers, or elastomers, used in tire manufacturing are butadiene rubber (BR) and styrene butadiene rubber (SBR). These synthetic rubber polymers are used in combination with natural rubber. The physical and chemical properties of these rubber polymers determine the performance of each component in the tire as well as the overall tire performance. Another important synthetic rubber is halogenated polyisobutylene rubber, commonly known as halobutyl rubber, which is used in the inner liner. This material causes the inner liner to have reduced air permeability, which helps to keep the tire inflated.

Tack: The stickiness of a green, or uncured, rubber compound.

Tire: As used in this document, “tire” refers to a pneumatic radial tire used with motor vehicles (*e.g.*, passenger cars and light duty trucks; heavy duty trucks and buses).

Tire Identification Number (TIN): A string of letters and numbers on the tire sidewall that begins with the letters DOT. New passenger and some new light truck tires are required by federal law to have a full TIN on the intended outboard side and a partial TIN on the intended inboard side. All new commercial truck and bus tires, motorcycle tires, and some light truck tires are required to have a full TIN on the intended outboard side.

Tire and Road Wear Particles (TRWP): Particles produced as the tire grips and interacts with the road surface during driving.

Tread: Located on the road-contacting portion of the tire, the tread rubber compound and tread pattern provide grip and abrasion resistance contributing to traction and treadwear.

Vulcanization: The process in which heat is applied to the green, or uncured, rubber compound causing a chemical reaction among sulfur, other chemicals, and polymers (elastomers) in the rubber compound. These reactions result in chemical bonds (cross links) between the polymer (elastomer) chains to produce cured tires.

Wear Rate: Usually measured in miles of travel per thousandth of an inch of tread depth loss (*i.e.*, miles per mil) or as tread loss per mileage increment (*i.e.*, mils/1,000 miles).

Appendix B

List of Products Covered by This AA

Responsible Entity Name	Brand/Trade Name	Tire Type
America Kenda Rubber Ind Co.	Kenda	Motorcycle Tires
America Kenda Rubber Ind Co.	Kenda	Light Duty Vehicle Tires
Apollo Tyres Limited	Apollo	Light Duty Vehicle Tires
Apollo Tyres Limited	Apollo	Medium Duty and Heavy Duty Vehicle Tires
Apollo Tyres Limited	Apollo	Motorcycle Tires
Apollo Tyres Limited	Vredestein	Light Duty Vehicle Tires
Bridgestone Americas, Inc.	Bandag	Retread Material for Tires
Bridgestone Americas, Inc.	Bridgestone	Light Duty Vehicle Tires
Bridgestone Americas, Inc.	Bridgestone	Medium and Heavy Duty Vehicle Tires
Bridgestone Americas, Inc.	Bridgestone	Motorcycle Tires
Bridgestone Americas, Inc.	Firestone	Light Duty Vehicle Tires
Bridgestone Americas, Inc.	Firestone	Medium and Heavy Duty Vehicle Tires
Bridgestone Americas, Inc.	Fuzion	Light Duty Vehicle Tires
Bridgestone Americas, Inc.	SureDrive	Light Duty Vehicle Tires
CEAT Limited	CEAT	Medium and Heavy Duty Vehicle Tires
CEAT Limited	CEAT	Light Duty Vehicle Tires
CEAT Limited	CEAT	Motorcycle Tires
CEAT Limited	Private label	Medium and Heavy Duty Vehicle Tires
CEAT Limited	Private label	Light Duty Vehicle Tires
China Manufacturers Alliance, LLC	Double Coin	Medium and Heavy Duty Dehicle tires
China Manufacturers Alliance, LLC	Warrior	Medium and Heavy Duty Dehicle tires
Continental Tire the Americas, LLC	Airfix	Light Duty Vehicle Tires
Continental Tire the Americas, LLC	Airfix	Medium Duty and Heavy Duty Tires
Continental Tire the Americas, LLC	Airfix	Motorcycle Tires
Continental Tire the Americas, LLC	Ameri*Steel	Medium Duty and Heavy Duty Tires
Continental Tire the Americas, LLC	America	Light Duty Vehicle Tires
Continental Tire the Americas, LLC	Bandvulc	Medium Duty and Heavy Duty Tires
Continental Tire the Americas, LLC	bandvulc	Retread Material for Tires
Continental Tire the Americas, LLC	Barum	Light Duty Vehicle Tires
Continental Tire the Americas, LLC	Barum	Medium Duty and Heavy Duty Tires
Continental Tire the Americas, LLC	Barum	Motorcycle Tires
Continental Tire the Americas, LLC	BestDrive	Light Duty Vehicle Tires
Continental Tire the Americas, LLC	Blackstone	Light Duty Vehicle Tires
Continental Tire the Americas, LLC	Capitol	Light Duty Vehicle Tires
Continental Tire the Americas, LLC	Continental	Medium and heavy duty tires
Continental Tire the Americas, LLC	Continental	Retread Material for Tires
Continental Tire the Americas, LLC	Continental	Light Duty Vehicle Tires
Continental Tire the Americas, LLC	Continental	Motorcycle Tires
Continental Tire the Americas, LLC	Contire	Medium Duty and Heavy Duty Tires
Continental Tire the Americas, LLC	Contitread	Retread Material for Tires
Continental Tire the Americas, LLC	Cosmos	Light Duty Vehicle Tires
Continental Tire the Americas, LLC	Dunlop	Light Duty Vehicle Tires
Continental Tire the Americas, LLC	Dunlop	Medium Duty and Heavy Duty Tires
Continental Tire the Americas, LLC	Dunlop	Motorcycle Tires
Continental Tire the Americas, LLC	ESA+ Tecar	Light Duty Vehicle Tires
Continental Tire the Americas, LLC	Eurostone	Light Duty Vehicle Tires
Continental Tire the Americas, LLC	Eurotec	Light Duty Vehicle Tires
Continental Tire the Americas, LLC	Eurotyre	Light Duty Vehicle Tires
Continental Tire the Americas, LLC	Euzkadi	Light Duty Vehicle Tires
Continental Tire the Americas, LLC	Euzkadi	Medium Duty and Heavy Duty Tires
Continental Tire the Americas, LLC	Fate	Light Duty Vehicle Tires
Continental Tire the Americas, LLC	Feu Vert	Light Duty Vehicle Tires
Continental Tire the Americas, LLC	Flamingo	Light Duty Vehicle Tires
Continental Tire the Americas, LLC	General	Light Duty Vehicle Tires
Continental Tire the Americas, LLC	General	Medium Duty and Heavy Duty Tires
Continental Tire the Americas, LLC	General	Motorcycle Tires
Continental Tire the Americas, LLC	General	Medium Duty and Heavy Duty Tires
Continental Tire the Americas, LLC	General Tire	Light Duty Vehicle Tires
Continental Tire the Americas, LLC	Gislaved	Light Duty Vehicle Tires
Continental Tire the Americas, LLC	Global	Light Duty Vehicle Tires
Continental Tire the Americas, LLC	Hoosier	Light Duty Vehicle Tires
Continental Tire the Americas, LLC	Kingstone	Medium Duty and Heavy Duty Tires
Continental Tire the Americas, LLC	Kormoran	Light Duty Vehicle Tires
Continental Tire the Americas, LLC	Mabor	Light Duty Vehicle Tires

Responsible Entity Name	Brand/Trade Name	Tire Type
Continental Tire the Americas, LLC	Marongoni	Medium Duty and Heavy Duty Tires
Continental Tire the Americas, LLC	Matador	Medium Duty and Heavy Duty Tires
Continental Tire the Americas, LLC	Matador	Light Duty Vehicle Tires
Continental Tire the Americas, LLC	Mazama	Light Duty Vehicle Tires
Continental Tire the Americas, LLC	Midas	Light Duty Vehicle Tires
Continental Tire the Americas, LLC	Midas	Motorcycle Tires
Continental Tire the Americas, LLC	Minerva	Light Duty Vehicle Tires
Continental Tire the Americas, LLC	MYCAR	Light Duty Vehicle Tires
Continental Tire the Americas, LLC	Nichols	Light Duty Vehicle Tires
Continental Tire the Americas, LLC	Norauto	Light Duty Vehicle Tires
Continental Tire the Americas, LLC	Paxaro	Light Duty Vehicle Tires
Continental Tire the Americas, LLC	Platin	Light Duty Vehicle Tires
Continental Tire the Americas, LLC	Point S	Light Duty Vehicle Tires
Continental Tire the Americas, LLC	Retrak	Medium Duty and Heavy Duty Tires
Continental Tire the Americas, LLC	Roadhandler	Light Duty Vehicle Tires
Continental Tire the Americas, LLC	ROADHOG	Light Duty Vehicle Tires
Continental Tire the Americas, LLC	Sebring	Light Duty Vehicle Tires
Continental Tire the Americas, LLC	Semperit	Medium Duty and Heavy Duty Tires
Continental Tire the Americas, LLC	Semperit	Motorcycle Tires
Continental Tire the Americas, LLC	Semperit	Light Duty Vehicle Tires
Continental Tire the Americas, LLC	Sidewinder	Light Duty Vehicle Tires
Continental Tire the Americas, LLC	Sime	Motorcycle Tires
Continental Tire the Americas, LLC	Sime Tyres	Light Duty Vehicle Tires
Continental Tire the Americas, LLC	SIME TYRES	Medium Duty and Heavy Duty Tires
Continental Tire the Americas, LLC	SIMEX	Light Duty Vehicle Tires
Continental Tire the Americas, LLC	SIMEX	Medium Duty and Heavy Duty Tires
Continental Tire the Americas, LLC	SIMEX	Motorcycle Tires
Continental Tire the Americas, LLC	Speedy	Light Duty Vehicle Tires
Continental Tire the Americas, LLC	Sportiva	Light Duty Vehicle Tires
Continental Tire the Americas, LLC	Sumitomo	Medium Duty and Heavy Duty Tires
Continental Tire the Americas, LLC	Sumo	Light Duty Vehicle Tires
Continental Tire the Americas, LLC	Taxat	Light Duty Vehicle Tires
Continental Tire the Americas, LLC	Team Star	Light Duty Vehicle Tires
Continental Tire the Americas, LLC	TEAMSTAR	Medium Duty and Heavy Duty Tires
Continental Tire the Americas, LLC	Tecnotread	Retread Material for Tires
Continental Tire the Americas, LLC	Tiger Wheel	Light Duty Vehicle Tires
Continental Tire the Americas, LLC	Toyo	Medium Duty and Heavy Duty Tires
Continental Tire the Americas, LLC	Truckstar	Medium Duty and Heavy Duty Tires
Continental Tire the Americas, LLC	Tyfoon	Light Duty Vehicle Tires
Continental Tire the Americas, LLC	Ultrex IV	Light Duty Vehicle Tires
Continental Tire the Americas, LLC	Uniroyal	Medium Duty and Heavy Duty Tires
Continental Tire the Americas, LLC	Uniroyal	Light Duty Vehicle Tires
Continental Tire the Americas, LLC	Uniroyal	Medium Duty and Heavy Duty Tires
Continental Tire the Americas, LLC	Viking	Light Duty Vehicle Tires
Continental Tire the Americas, LLC	Yokohama	Light Duty Vehicle Tires
Continental Tire the Americas, LLC	Yokohama	Medium Duty and Heavy Duty Tires
Giti Tire	Dextero	Light Duty Vehicle Tires
Giti Tire	Giti	Light Duty Vehicle Tires
Giti Tire	Giti	Medium Duty and Heavy Duty Tires
Giti Tire	GT Radial	Light Duty Vehicle Tires
Giti Tire	GT Radial	Medium Duty and Heavy Duty Tires
Giti Tire	Primewell	Light Duty Vehicle Tires
Giti Tire	Rocky Mountain	Light Duty Vehicle Tires
Giti Tire	Runway	Light Duty Vehicle Tires
Guizhou Tyre Co., Ltd.	ADVANCE	Light Duty Vehicle Tires
Guizhou Tyre Co., Ltd.	ADVANCE	Medium Duty and Heavy Duty Tires
Guizhou Tyre Co., Ltd.	SAMSON	Medium Duty and Heavy Duty Tires
Guizhou Tyre Co., Ltd.	SAMSON	Light Duty Vehicle Tires
Guizhou Tyre Co., Ltd.	TORNADO	Medium Duty and Heavy Duty Tires
Guizhou Tyre Co., Ltd.	TORNADO	Light Duty Vehicle Tires
Hankook Tire America Corporation	Hankook	Light Duty Vehicle Tires
Hankook Tire America Corporation	Hankook	Medium Duty Vehicle Tires
Hankook Tire America Corporation	Hankook	Heavy Duty Vehicle Tires
Hankook Tire America Corporation	Hankook & New Englander	Light Duty Vehicle Tires

Responsible Entity Name	Brand/Trade Name	Tire Type
Hankook Tire America Corporation	Hankook & Traction Control	Light Duty Vehicle Tires
Hankook Tire America Corporation	Laufenn	Light Duty Vehicle Tires
Hankook Tire America Corporation	Laufenn	Medium Duty Vehicle Tires
Hankook Tire America Corporation	Laufenn	Heavy Duty Vehicle Tires
Hankook Tire America Corporation	PathFinder	Light Duty Vehicle Tires
Hankook Tire America Corporation	Statewide	Light Duty Vehicle Tires
Hebei Wanda Tyre Co., Ltd.	AIR-LOC	Light Duty Vehicle Tires
Hebei Wanda Tyre Co., Ltd.	ALL STAR	Light Duty Vehicle Tires
Hebei Wanda Tyre Co., Ltd.	AMERITRAIL	Light Duty Vehicle Tires
Hebei Wanda Tyre Co., Ltd.	AMS	Light Duty Vehicle Tires
Hebei Wanda Tyre Co., Ltd.	ANTEGO	Light Duty Vehicle Tires
Hebei Wanda Tyre Co., Ltd.	BLACK TRAIL	Light Duty Vehicle Tires
Hebei Wanda Tyre Co., Ltd.	CADDIE MASTER	Light Duty Vehicle Tires
Hebei Wanda Tyre Co., Ltd.	CARAWAY	Light Duty Vehicle Tires
Hebei Wanda Tyre Co., Ltd.	DEWOSTONE	Light Duty Vehicle Tires
Hebei Wanda Tyre Co., Ltd.	ECO TRAIL ST	Light Duty Vehicle Tires
Hebei Wanda Tyre Co., Ltd.	EFX	Light Duty Vehicle Tires
Hebei Wanda Tyre Co., Ltd.	ELEVATE STR	Light Duty Vehicle Tires
Hebei Wanda Tyre Co., Ltd.	EVOLUTION	Light Duty Vehicle Tires
Hebei Wanda Tyre Co., Ltd.	EXCEL	Light Duty Vehicle Tires
Hebei Wanda Tyre Co., Ltd.	FREE COUNTRY	Light Duty Vehicle Tires
Hebei Wanda Tyre Co., Ltd.	GOLBALTRAX	Light Duty Vehicle Tires
Hebei Wanda Tyre Co., Ltd.	GOLDENWEST	Light Duty Vehicle Tires
Hebei Wanda Tyre Co., Ltd.	GOLFPPLUS	Light Duty Vehicle Tires
Hebei Wanda Tyre Co., Ltd.	HAKUBA	Light Duty Vehicle Tires
Hebei Wanda Tyre Co., Ltd.	HI-RUN	Light Duty Vehicle Tires
Hebei Wanda Tyre Co., Ltd.	INTERCO	Light Duty Vehicle Tires
Hebei Wanda Tyre Co., Ltd.	JET STAR	Light Duty Vehicle Tires
Hebei Wanda Tyre Co., Ltd.	JIMEXS	Light Duty Vehicle Tires
Hebei Wanda Tyre Co., Ltd.	JOURNEY	Light Duty Vehicle Tires
Hebei Wanda Tyre Co., Ltd.	K9	Light Duty Vehicle Tires
Hebei Wanda Tyre Co., Ltd.	LSI ELITE	Light Duty Vehicle Tires
Hebei Wanda Tyre Co., Ltd.	MAXAUTO	Light Duty Vehicle Tires
Hebei Wanda Tyre Co., Ltd.	MILESTAR	Light Duty Vehicle Tires
Hebei Wanda Tyre Co., Ltd.	MODZ	Light Duty Vehicle Tires
Hebei Wanda Tyre Co., Ltd.	NANCO	Light Duty Vehicle Tires
Hebei Wanda Tyre Co., Ltd.	OBOR	Light Duty Vehicle Tires
Hebei Wanda Tyre Co., Ltd.	OCELOT	Light Duty Vehicle Tires
Hebei Wanda Tyre Co., Ltd.	OTR	Light Duty Vehicle Tires
Hebei Wanda Tyre Co., Ltd.	POWER KING	Light Duty Vehicle Tires
Hebei Wanda Tyre Co., Ltd.	PRIMEX	Light Duty Vehicle Tires
Hebei Wanda Tyre Co., Ltd.	RAINIER ST	Light Duty Vehicle Tires
Hebei Wanda Tyre Co., Ltd.	RHOX	Light Duty Vehicle Tires
Hebei Wanda Tyre Co., Ltd.	RUBBERMASTER	Light Duty Vehicle Tires
Hebei Wanda Tyre Co., Ltd.	SLINGSHOTXT	Light Duty Vehicle Tires
Hebei Wanda Tyre Co., Ltd.	SPEEDUTV	Light Duty Vehicle Tires
Hebei Wanda Tyre Co., Ltd.	STEELENG	Light Duty Vehicle Tires
Hebei Wanda Tyre Co., Ltd.	SUPER GRIP	Light Duty Vehicle Tires
Hebei Wanda Tyre Co., Ltd.	SYNERGY	Light Duty Vehicle Tires
Hebei Wanda Tyre Co., Ltd.	TEX STAR	Light Duty Vehicle Tires
Hebei Wanda Tyre Co., Ltd.	TRAC GARD	Light Duty Vehicle Tires
Hebei Wanda Tyre Co., Ltd.	TRAILFINDER	Light Duty Vehicle Tires
Hebei Wanda Tyre Co., Ltd.	TRAILQUEST	Light Duty Vehicle Tires
Hebei Wanda Tyre Co., Ltd.	TRAXION	Light Duty Vehicle Tires
Hebei Wanda Tyre Co., Ltd.	TREAD-STAR	Light Duty Vehicle Tires
Hebei Wanda Tyre Co., Ltd.	TUSK	Light Duty Vehicle Tires
Hebei Wanda Tyre Co., Ltd.	VISION	Light Duty Vehicle Tires
Hebei Wanda Tyre Co., Ltd.	WANDA	Light Duty Vehicle Tires
Hebei Wanda Tyre Co., Ltd.	WD-SIGNATURE	Light Duty Vehicle Tires
Hebei Wanda Tyre Co., Ltd.	WDT	Light Duty Vehicle Tires
Hebei Wanda Tyre Co., Ltd.	WD-VELOCITY	Light Duty Vehicle Tires
Hebei Wanda Tyre Co., Ltd.	wolfpack	Light Duty Vehicle Tires
Hebei Wanda Tyre Co., Ltd.	ZEEMAX	Light Duty Vehicle Tires
Jiangsu General Science Technology Co., Ltd.	Achilles	Light Duty Vehicle Tires

Responsible Entity Name	Brand/Trade Name	Tire Type
Jiangsu General Science Technology Co., Ltd.	Advanta	Medium Duty and Heavy Duty Vehicle Tires
Jiangsu General Science Technology Co., Ltd.	Advanta	Light Duty Vehicle Tires
Jiangsu General Science Technology Co., Ltd.	American Roadstar	Light Duty Vehicle Tires
Jiangsu General Science Technology Co., Ltd.	American Roadstar	Medium Duty and Heavy Duty Vehicle Tires
Jiangsu General Science Technology Co., Ltd.	Antini	Medium Duty and Heavy Duty Vehicle Tires
Jiangsu General Science Technology Co., Ltd.	Arroyo	Light Duty Vehicle Tires
Jiangsu General Science Technology Co., Ltd.	Arroyo	Medium Duty and Heavy Duty Vehicle Tires
Jiangsu General Science Technology Co., Ltd.	Atlander	Medium Duty and Heavy Duty Vehicle Tires
Jiangsu General Science Technology Co., Ltd.	Atlander	Light Duty Vehicle Tires
Jiangsu General Science Technology Co., Ltd.	Atturo	Light Duty Vehicle Tires
Jiangsu General Science Technology Co., Ltd.	Aufine	Medium Duty and Heavy Duty Vehicle Tires
Jiangsu General Science Technology Co., Ltd.	Barkley	Medium Duty and Heavy Duty Vehicle Tires
Jiangsu General Science Technology Co., Ltd.	Barkley	Light Duty Vehicle Tires
Jiangsu General Science Technology Co., Ltd.	CELIMO	Light Duty Vehicle Tires
Jiangsu General Science Technology Co., Ltd.	CELIMO	Medium Duty and Heavy Duty Vehicle Tires
Jiangsu General Science Technology Co., Ltd.	Converse	Light Duty Vehicle Tires
Jiangsu General Science Technology Co., Ltd.	Duro	Light Duty Vehicle Tires
Jiangsu General Science Technology Co., Ltd.	Evertour	Medium Duty and Heavy Duty Vehicle Tires
Jiangsu General Science Technology Co., Ltd.	Finalist	Light Duty Vehicle Tires
Jiangsu General Science Technology Co., Ltd.	Finalist	Medium Duty and Heavy Duty Vehicle Tires
Jiangsu General Science Technology Co., Ltd.	Fury Off Road	Light Duty Vehicle Tires
Jiangsu General Science Technology Co., Ltd.	Gladiator	Medium Duty and Heavy Duty Vehicle Tires
Jiangsu General Science Technology Co., Ltd.	Gladiator	Light Duty Vehicle Tires
Jiangsu General Science Technology Co., Ltd.	Goodtrip	Light Duty Vehicle Tires
Jiangsu General Science Technology Co., Ltd.	Goodtrip	Medium Duty and Heavy Duty Vehicle Tires
Jiangsu General Science Technology Co., Ltd.	Gremax	Light Duty Vehicle Tires
Jiangsu General Science Technology Co., Ltd.	Gremax	Medium Duty and Heavy Duty Vehicle Tires
Jiangsu General Science Technology Co., Ltd.	Gripmax	Light Duty Vehicle Tires
Jiangsu General Science Technology Co., Ltd.	Gripower	Medium Duty and Heavy Duty Vehicle Tires
Jiangsu General Science Technology Co., Ltd.	Hillrock	Medium Duty and Heavy Duty Vehicle Tires
Jiangsu General Science Technology Co., Ltd.	Knight	Medium Duty and Heavy Duty Vehicle Tires
Jiangsu General Science Technology Co., Ltd.	Kwik	Light Duty Vehicle Tires
Jiangsu General Science Technology Co., Ltd.	Lancaster	Medium Duty and Heavy Duty Vehicle Tires
Jiangsu General Science Technology Co., Ltd.	Lancaster	Light Duty Vehicle Tires
Jiangsu General Science Technology Co., Ltd.	Landspider	Light Duty Vehicle Tires
Jiangsu General Science Technology Co., Ltd.	Landspider	Medium Duty and Heavy Duty Vehicle Tires
Jiangsu General Science Technology Co., Ltd.	Lenso	Light Duty Vehicle Tires
Jiangsu General Science Technology Co., Ltd.	Lexmont	Medium Duty and Heavy Duty Vehicle Tires
Jiangsu General Science Technology Co., Ltd.	Longmarch	Medium Duty and Heavy Duty Vehicle Tires
Jiangsu General Science Technology Co., Ltd.	Magna	Medium Duty and Heavy Duty Vehicle Tires
Jiangsu General Science Technology Co., Ltd.	Mastertrack	Light Duty Vehicle Tires
Jiangsu General Science Technology Co., Ltd.	Mastertrack	Medium Duty and Heavy Duty Vehicle Tires
Jiangsu General Science Technology Co., Ltd.	Matrax	Light Duty Vehicle Tires
Jiangsu General Science Technology Co., Ltd.	Matrix	Light Duty Vehicle Tires
Jiangsu General Science Technology Co., Ltd.	Mazzini	Medium Duty and Heavy Duty Vehicle Tires
Jiangsu General Science Technology Co., Ltd.	Megalodon	Medium Duty and Heavy Duty Vehicle Tires
Jiangsu General Science Technology Co., Ltd.	Milestar	Light Duty Vehicle Tires
Jiangsu General Science Technology Co., Ltd.	Miletrip	Light Duty Vehicle Tires
Jiangsu General Science Technology Co., Ltd.	Mud Claw	Light Duty Vehicle Tires
Jiangsu General Science Technology Co., Ltd.	Nama	Light Duty Vehicle Tires
Jiangsu General Science Technology Co., Ltd.	Navitrac	Medium Duty and Heavy Duty Vehicle Tires
Jiangsu General Science Technology Co., Ltd.	Nebula	Light Duty Vehicle Tires
Jiangsu General Science Technology Co., Ltd.	Neoterra	Medium Duty and Heavy Duty Vehicle Tires
Jiangsu General Science Technology Co., Ltd.	Neoterra	Light Duty Vehicle Tires
Jiangsu General Science Technology Co., Ltd.	Randhawa	Medium Duty and Heavy Duty Vehicle Tires
Jiangsu General Science Technology Co., Ltd.	Rockfleet	Medium Duty and Heavy Duty Vehicle Tires
Jiangsu General Science Technology Co., Ltd.	Sentinel	Light Duty Vehicle Tires
Jiangsu General Science Technology Co., Ltd.	Sentinel	Medium Duty and Heavy Duty Vehicle Tires
Jiangsu General Science Technology Co., Ltd.	Supercargo	Medium Duty and Heavy Duty Vehicle Tires
Jiangsu General Science Technology Co., Ltd.	TBBtires	Light Duty Vehicle Tires
Jiangsu General Science Technology Co., Ltd.	TBBtires	Medium Duty and Heavy Duty Vehicle Tires
Jiangsu General Science Technology Co., Ltd.	Tekpro	Medium Duty and Heavy Duty Vehicle Tires
Jiangsu General Science Technology Co., Ltd.	Tesche	Light Duty Vehicle Tires
Jiangsu General Science Technology Co., Ltd.	Tomoro	Medium Duty and Heavy Duty Vehicle Tires

Responsible Entity Name	Brand/Trade Name	Tire Type
Jiangsu General Science Technology Co., Ltd.	Towmax	Light Duty Vehicle Tires
Jiangsu General Science Technology Co., Ltd.	Travelstar	Light Duty Vehicle Tires
Jiangsu General Science Technology Co., Ltd.	Travelstar	Medium Duty and Heavy Duty Vehicle Tires
Jiangsu General Science Technology Co., Ltd.	Unigrip	Light Duty Vehicle Tires
Jiangsu General Science Technology Co., Ltd.	Vantage	Light Duty Vehicle Tires
Jiangsu General Science Technology Co., Ltd.	Venom Power	Light Duty Vehicle Tires
Jiangsu General Science Technology Co., Ltd.	Vitour	Medium Duty and Heavy Duty Vehicle Tires
Jiangsu General Science Technology Co., Ltd.	Xcellent	Light Duty Vehicle Tires
Jiangsu General Science Technology Co., Ltd.	Xcellent	Medium Duty and Heavy Duty Vehicle Tires
Jiangsu General Science Technology Co., Ltd.	Zenna	Light Duty Vehicle Tires
Jiangsu General Science Technology Co., Ltd.	Zenna	Medium Duty and Heavy Duty Vehicle Tires
JK Tyre and Industries Limited	Celestis	Medium Duty and Heavy Duty Vehicle Tires
JK Tyre and Industries Limited	Coker	Light Duty Vehicle Tires
JK Tyre and Industries Limited	Ironman	Light Duty Vehicle Tires
JK Tyre and Industries Limited	JK Tyre	Medium Duty and Heavy Duty Vehicle Tires
JK Tyre and Industries Limited	JK Tyre	Light Duty Vehicle Tires
JK Tyre and Industries Limited	New Pride	Medium Duty and Heavy Duty Vehicle Tires
JK Tyre and Industries Limited	Pearly	Medium Duty and Heavy Duty Vehicle Tires
JK Tyre and Industries Limited	Tornel	Light Duty Vehicle Tires
JK Tyre and Industries Limited	Vikrant	Medium Duty and Heavy Duty Vehicle Tires
Kumho Tire	Kumho Tire	Light Duty Vehicle Tires
Kumho Tire	Kumho Tire	Medium Duty and Heavy Duty Vehicle Tires
Linglong Americas	Altenzo	Light Duty Vehicle Tires
Linglong Americas	AMP	Light Duty Vehicle Tires
Linglong Americas	Annex	Light Duty Vehicle Tires
Linglong Americas	Atlas	Light Duty Vehicle Tires
Linglong Americas	Atlas	Medium Duty and Heavy Duty Vehicle Tires
Linglong Americas	Aufine	Medium Duty and Heavy Duty Vehicle Tires
Linglong Americas	Black Bear	Light Duty Vehicle Tires
Linglong Americas	Constellation	Medium Duty and Heavy Duty Vehicle Tires
Linglong Americas	Contender	Light Duty Vehicle Tires
Linglong Americas	Crosswind	Light Duty Vehicle Tires
Linglong Americas	Crosswind	Medium Duty and Heavy Duty Vehicle Tires
Linglong Americas	Custom	Light Duty Vehicle Tires
Linglong Americas	Dynatrac	Light Duty Vehicle Tires
Linglong Americas	Dynatrac	Medium Duty and Heavy Duty Vehicle Tires
Linglong Americas	Epic Tour	Light Duty Vehicle Tires
Linglong Americas	Evoluxx	Light Duty Vehicle Tires
Linglong Americas	Evoluxx	Medium Duty and Heavy Duty Vehicle Tires
Linglong Americas	Finalist	Light Duty Vehicle Tires
Linglong Americas	Freedom Hauler	Light Duty Vehicle Tires
Linglong Americas	Freedom Hauler	Medium Duty and Heavy Duty Vehicle Tires
Linglong Americas	Geostar	Light Duty Vehicle Tires
Linglong Americas	Geostar	Medium Duty and Heavy Duty Vehicle Tires
Linglong Americas	Geo-Trac	Light Duty Vehicle Tires
Linglong Americas	Giovanna	Light Duty Vehicle Tires
Linglong Americas	Gladiator	Light Duty Vehicle Tires
Linglong Americas	Gladiator	Medium Duty and Heavy Duty Vehicle Tires
Linglong Americas	GREEN-Max	Light Duty Vehicle Tires
Linglong Americas	GREEN-Max	Medium Duty and Heavy Duty Vehicle Tires
Linglong Americas	Gripmax	Light Duty Vehicle Tires
Linglong Americas	Gripmax	Medium Duty and Heavy Duty Vehicle Tires
Linglong Americas	Gripower	Medium Duty and Heavy Duty Vehicle Tires
Linglong Americas	Grit King	Light Duty Vehicle Tires
Linglong Americas	Grit Master	Light Duty Vehicle Tires
Linglong Americas	Hemisphere	Light Duty Vehicle Tires
Linglong Americas	Hercules	Light Duty Vehicle Tires
Linglong Americas	Hercules	Medium Duty and Heavy Duty Vehicle Tires
Linglong Americas	Hubtrac	Medium Duty and Heavy Duty Vehicle Tires
Linglong Americas	Ironman	Light Duty Vehicle Tires
Linglong Americas	Ironman	Medium Duty and Heavy Duty Vehicle Tires
Linglong Americas	Leao	Light Duty Vehicle Tires
Linglong Americas	Leao	Medium Duty and Heavy Duty Vehicle Tires
Linglong Americas	Linglong	Light Duty Vehicle Tires

Responsible Entity Name	Brand/Trade Name	Tire Type
Linglong Americas	Linglong	Medium Duty and Heavy Duty Vehicle Tires
Linglong Americas	Milestar	Light Duty Vehicle Tires
Linglong Americas	Nama	Medium Duty and Heavy Duty Vehicle Tires
Linglong Americas	Omni	Light Duty Vehicle Tires
Linglong Americas	Percheron	Light Duty Vehicle Tires
Linglong Americas	Percheron	Medium Duty and Heavy Duty Vehicle Tires
Linglong Americas	Performer	Light Duty Vehicle Tires
Linglong Americas	Pinnacle	Light Duty Vehicle Tires
Linglong Americas	Pinnacle	Medium Duty and Heavy Duty Vehicle Tires
Linglong Americas	Predator	Light Duty Vehicle Tires
Linglong Americas	Prometer	Light Duty Vehicle Tires
Linglong Americas	Prometer	Medium Duty and Heavy Duty Vehicle Tires
Linglong Americas	Provato	Medium Duty and Heavy Duty Vehicle Tires
Linglong Americas	Provato	Light Duty Vehicle Tires
Linglong Americas	Provider	Light Duty Vehicle Tires
Linglong Americas	Provider	Medium Duty and Heavy Duty Vehicle Tires
Linglong Americas	Remington	Light Duty Vehicle Tires
Linglong Americas	RoadOne	Light Duty Vehicle Tires
Linglong Americas	Roadone	Medium Duty and Heavy Duty Vehicle Tires
Linglong Americas	Sentry	Medium Duty and Heavy Duty Vehicle Tires
Linglong Americas	Solidana	Medium Duty and Heavy Duty Vehicle Tires
Linglong Americas	Super Cargo	Medium Duty and Heavy Duty Vehicle Tires
Linglong Americas	Superior	Medium Duty and Heavy Duty Vehicle Tires
Linglong Americas	Suretrac	Light Duty Vehicle Tires
Linglong Americas	Suretrac	Medium Duty and Heavy Duty Vehicle Tires
Linglong Americas	Symmetry	Light Duty Vehicle Tires
Linglong Americas	Synergy	Medium Duty and Heavy Duty Vehicle Tires
Linglong Americas	Taskmaster	Light Duty Vehicle Tires
Linglong Americas	Trailermaster	Light Duty Vehicle Tires
Linglong Americas	Trailermaster	Medium Duty and Heavy Duty Vehicle Tires
Linglong Americas	TransEagle	Light Duty Vehicle Tires
Linglong Americas	TransEagle	Medium Duty and Heavy Duty Vehicle Tires
Linglong Americas	Travelstar	Light Duty Vehicle Tires
Linglong Americas	Travelstar	Medium Duty and Heavy Duty Vehicle Tires
Linglong Americas	Tri-Ace	Light Duty Vehicle Tires
Linglong Americas	Venezia	Light Duty Vehicle Tires
Linglong Americas	Venom Power	Light Duty Vehicle Tires
Linglong Americas	Venom Power	Medium Duty and Heavy Duty Vehicle Tires
Linglong Americas	Vercelli	Light Duty Vehicle Tires
Linglong Americas	Versatyre	Light Duty Vehicle Tires
Linglong Americas	Wild Spirit	Light Duty Vehicle Tires
Linglong Americas	Zenna	Light Duty Vehicle Tires
Linglong Americas	Zenna	Medium Duty and Heavy Duty Vehicle Tires
Maxxis Technology Center (Cheng Shin USA Tech Center)	Maxxis	Light Duty Vehicle Tires
Maxxis Technology Center (Cheng Shin USA Tech Center)	Maxxis	Medium Duty and Heavy Duty Vehicle Tires
Michelin North America Inc.	BF Goodrich	Light Duty Vehicle Tires
Michelin North America Inc.	BF Goodrich	Medium Duty and Heavy Duty Vehicle Tires
Michelin North America Inc.	Megamile	Retread Material for Tires
Michelin North America Inc.	Michelin	Light Duty Vehicle Tires
Michelin North America Inc.	Michelin	Medium Duty and Heavy Duty Vehicle Tires
Michelin North America Inc.	Michelin	Motorcycle Tires
Michelin North America Inc.	Michelin	Retread Material for Tires
Michelin North America Inc.	Oliver	Retread Material for Tires
Michelin North America Inc.	Recamic	Retread Material for Tires
Michelin North America Inc.	Riken	Light Duty Vehicle Tires
Michelin North America Inc.	Uniroyal	Light Duty Vehicle Tires
Michelin North America Inc.	Uniroyal	Medium Duty and Heavy Duty Vehicle Tires
Michelin North America, Inc. on behalf of PT Multistrada Arah Sarana TBK	ACHILLES	Light Duty Vehicle Tires
Michelin North America, Inc. on behalf of PT Multistrada Arah Sarana TBK	ACHILLES	Medium and Heavy Duty Tires
Michelin North America, Inc. on behalf of PT Multistrada Arah Sarana TBK	ATR 122	Light Duty Vehicle Tires
Michelin North America, Inc. on behalf of PT Multistrada Arah Sarana TBK	ATR RADIAL	Light Duty Vehicle Tires
Michelin North America, Inc. on behalf of PT Multistrada Arah Sarana TBK	ATR SPORT	Light Duty Vehicle Tires
Michelin North America, Inc. on behalf of PT Multistrada Arah Sarana TBK	ATR-K	Light Duty Vehicle Tires
Michelin North America, Inc. on behalf of PT Multistrada Arah Sarana TBK	BELLAGIO	Light Duty Vehicle Tires

Responsible Entity Name	Brand/Trade Name	Tire Type
Michelin North America, Inc. on behalf of PT Multistrada Arah Sarana TBK	CORSA	Motorcycle Tires
Michelin North America, Inc. on behalf of PT Multistrada Arah Sarana TBK	CORSA	Light Duty Vehicle Tires
Michelin North America, Inc. on behalf of PT Multistrada Arah Sarana TBK	GOLDENBRIDGE	Light Duty Vehicle Tires
Michelin North America, Inc. on behalf of PT Multistrada Arah Sarana TBK	MILESTAR	Light Duty Vehicle Tires
Michelin North America, Inc. on behalf of PT Multistrada Arah Sarana TBK	MONTANA	Light Duty Vehicle Tires
Michelin North America, Inc. on behalf of PT Multistrada Arah Sarana TBK	NEUTON	Light Duty Vehicle Tires
Michelin North America, Inc. on behalf of PT Multistrada Arah Sarana TBK	PINSO	Light Duty Vehicle Tires
Michelin North America, Inc. on behalf of PT Multistrada Arah Sarana TBK	RADAR	Light Duty Vehicle Tires
Michelin North America, Inc. on behalf of PT Multistrada Arah Sarana TBK	SINGA RADIAL	Light Duty Vehicle Tires
Michelin North America, Inc. on behalf of PT Multistrada Arah Sarana TBK	STRADA	Light Duty Vehicle Tires
Michelin North America, Inc. on behalf of PT Multistrada Arah Sarana TBK	SYRON	Light Duty Vehicle Tires
NEXEN TIRE CORPORATION	Aspen	Light Duty Vehicle Tires
NEXEN TIRE CORPORATION	Geotour	Light Duty Vehicle Tires
NEXEN TIRE CORPORATION	Hercules	Light Duty Vehicle Tires
NEXEN TIRE CORPORATION	NEXEN	Light Duty Vehicle Tires
NEXEN TIRE CORPORATION	Sceptor	Light Duty Vehicle Tires
NEXEN TIRE CORPORATION	Solar	Light Duty Vehicle Tires
Nokian Tyres US Operations LLC	Nokian Tyres	Light Duty Vehicle Tires
Nokian Tyres US Operations LLC	Nokian Tyres	Medium Duty and Heavy Duty Vehicle Tires
Nokian Tyres US Operations LLC	Nokian Tyres	Retread Material for Tires
Nokian Tyres US Operations LLC	Nordman	Light Duty Vehicle Tires
Nokian Tyres US Operations LLC	Private brand	Light Duty Vehicle Tires
Ohtani Radial Co., Ltd	Otani	Tires
Otani Tire Co., Ltd	Otani	Tires
Pirelli Tire LLC	Metzeler	Motorcycle Tires
Pirelli Tire LLC	Pirelli	Light Duty Vehicle Tires
Pirelli Tire LLC	Pirelli	Motorcycle Tires
Prinx Chengshan Holdings Limited	AMP/TWG	Light Duty Vehicle Tires
Prinx Chengshan Holdings Limited	Crossmax/Otai	Light Duty Vehicle Tires
Prinx Chengshan Holdings Limited	Fortune	Medium Duty and Heavy Duty Vehicle Tires
Prinx Chengshan Holdings Limited	Fortune	Light Duty Vehicle Tires
Prinx Chengshan Holdings Limited	Kelly/Goodyear	Medium Duty and Heavy Duty Vehicle Tires
Prinx Chengshan Holdings Limited	Muscle Power/Delta	Medium Duty and Heavy Duty Vehicle Tires
Prinx Chengshan Holdings Limited	Pathraider/Otai	Light Duty Vehicle Tires
Prinx Chengshan Holdings Limited	Prinx	Light Duty Vehicle Tires
Prinx Chengshan Holdings Limited	Prinx	Medium Duty and Heavy Duty Vehicle Tires
Prinx Chengshan Holdings Limited	Radar/Omni United	Light Duty Vehicle Tires
Prinx Chengshan Holdings Limited	Rainier St/Otai	Light Duty Vehicle Tires
Prinx Chengshan Holdings Limited	Sotera/Otai	Medium Duty and Heavy Duty Vehicle Tires
Prinx Chengshan Holdings Limited	Synergy/Sutong	Medium Duty and Heavy Duty Vehicle Tires
Prinx Chengshan Holdings Limited	Tourador/Otai	Medium Duty and Heavy Duty Vehicle Tires
Prinx Chengshan Holdings Limited	UniRoyal/TBC	Medium Duty and Heavy Duty Vehicle Tires
Prinx Chengshan Holdings Limited	Wellplus/Otai	Medium Duty and Heavy Duty Vehicle Tires
Prometeon Tyre Group Commercial Solutions, LLC	Nextroad	Medium and Heavy Duty Vehicle Tires
Prometeon Tyre Group Commercial Solutions, LLC	Pirelli	Medium and Heavy Duty Vehicle Tires
Qingdao Sentury Tire Co., Ltd.	AEROTYRE	Medium and Heavy Duty Vehicle Tires
Qingdao Sentury Tire Co., Ltd.	ALBOURGH	Medium and Heavy Duty Vehicle Tires
Qingdao Sentury Tire Co., Ltd.	ALBOURGH	Light Duty Vehicle Tires
Qingdao Sentury Tire Co., Ltd.	AMERICAN ROAD STAR	Medium and Heavy Duty Vehicle Tires
Qingdao Sentury Tire Co., Ltd.	AMERICAN ROAD STAR	Light Duty Vehicle Tires
Qingdao Sentury Tire Co., Ltd.	AMERICAN TOURER	Light Duty Vehicle Tires
Qingdao Sentury Tire Co., Ltd.	ARROYO	Medium and Heavy Duty Vehicle Tires
Qingdao Sentury Tire Co., Ltd.	ARROYO	Light Duty Vehicle Tires
Qingdao Sentury Tire Co., Ltd.	AVANTECH	Medium and Heavy Duty Vehicle Tires
Qingdao Sentury Tire Co., Ltd.	Avantech	Light Duty Vehicle Tires
Qingdao Sentury Tire Co., Ltd.	BARKLEY	Medium and Heavy Duty Vehicle Tires
Qingdao Sentury Tire Co., Ltd.	BARKLEY	Light Duty Vehicle Tires
Qingdao Sentury Tire Co., Ltd.	DAVANTI	Light Duty Vehicle Tires
Qingdao Sentury Tire Co., Ltd.	DCENTI	Light Duty Vehicle Tires
Qingdao Sentury Tire Co., Ltd.	Delinte	Medium and Heavy Duty Vehicle Tires
Qingdao Sentury Tire Co., Ltd.	Delinte	Light Duty Vehicle Tires
Qingdao Sentury Tire Co., Ltd.	DELTA	Light Duty Vehicle Tires
Qingdao Sentury Tire Co., Ltd.	ELDORAD	Light Duty Vehicle Tires
Qingdao Sentury Tire Co., Ltd.	GREENTRAC	Medium and Heavy Duty Vehicle Tires

Responsible Entity Name	Brand/Trade Name	Tire Type
Qingdao Sentury Tire Co., Ltd.	GREENTRAC	Light Duty Vehicle Tires
Qingdao Sentury Tire Co., Ltd.	Groundspeed	Medium and Heavy Duty Vehicle Tires
Qingdao Sentury Tire Co., Ltd.	Groundspeed	Light Duty Vehicle Tires
Qingdao Sentury Tire Co., Ltd.	HOPEWAY	Medium and Heavy Duty Vehicle Tires
Qingdao Sentury Tire Co., Ltd.	KADO	Medium and Heavy Duty Vehicle Tires
Qingdao Sentury Tire Co., Ltd.	Kinforest	Medium and Heavy Duty Vehicle Tires
Qingdao Sentury Tire Co., Ltd.	KINFOREST	Light Duty Vehicle Tires
Qingdao Sentury Tire Co., Ltd.	LANDFLEET	Light Duty Vehicle Tires
Qingdao Sentury Tire Co., Ltd.	LANDFLEET	Medium and Heavy Duty Vehicle Tires
Qingdao Sentury Tire Co., Ltd.	LANDGOLDEN	Medium and Heavy Duty Vehicle Tires
Qingdao Sentury Tire Co., Ltd.	LANDGOLDEN	Light Duty Vehicle Tires
Qingdao Sentury Tire Co., Ltd.	LANDSAIL	Light Duty Vehicle Tires
Qingdao Sentury Tire Co., Ltd.	LANDSAIL	Medium and Heavy Duty Vehicle Tires
Qingdao Sentury Tire Co., Ltd.	LAZZAZ	Medium and Heavy Duty Vehicle Tires
Qingdao Sentury Tire Co., Ltd.	LEXANI	Light Duty Vehicle Tires
Qingdao Sentury Tire Co., Ltd.	LIONHART	Medium and Heavy Duty Vehicle Tires
Qingdao Sentury Tire Co., Ltd.	LIONHART	Light Duty Vehicle Tires
Qingdao Sentury Tire Co., Ltd.	MASTERSTEEL	Light Duty Vehicle Tires
Qingdao Sentury Tire Co., Ltd.	Mavis	Light Duty Vehicle Tires
Qingdao Sentury Tire Co., Ltd.	MOHAVE	Light Duty Vehicle Tires
Qingdao Sentury Tire Co., Ltd.	MUDDER TRUCKER	Light Duty Vehicle Tires
Qingdao Sentury Tire Co., Ltd.	MULTI-MILE	Light Duty Vehicle Tires
Qingdao Sentury Tire Co., Ltd.	NATIONAL	Light Duty Vehicle Tires
Qingdao Sentury Tire Co., Ltd.	NEBULA	Medium and Heavy Duty Vehicle Tires
Qingdao Sentury Tire Co., Ltd.	NEBULA	Light Duty Vehicle Tires
Qingdao Sentury Tire Co., Ltd.	NEOTERRA	Medium and Heavy Duty Vehicle Tires
Qingdao Sentury Tire Co., Ltd.	PACE	Medium and Heavy Duty Vehicle Tires
Qingdao Sentury Tire Co., Ltd.	PANTERA	Light Duty Vehicle Tires
Qingdao Sentury Tire Co., Ltd.	PATRIOT	Light Duty Vehicle Tires
Qingdao Sentury Tire Co., Ltd.	PHYRON	Light Duty Vehicle Tires
Qingdao Sentury Tire Co., Ltd.	PHYRON	Medium and Heavy Duty Vehicle Tires
Qingdao Sentury Tire Co., Ltd.	RADAR	Medium and Heavy Duty Vehicle Tires
Qingdao Sentury Tire Co., Ltd.	RADAR	Light Duty Vehicle Tires
Qingdao Sentury Tire Co., Ltd.	Raiden	Light Duty Vehicle Tires
Qingdao Sentury Tire Co., Ltd.	ROADHOG	Light Duty Vehicle Tires
Qingdao Sentury Tire Co., Ltd.	ROLLING BIG POWER	Medium and Heavy Duty Vehicle Tires
Qingdao Sentury Tire Co., Ltd.	ROLLING BIG POWER	Light Duty Vehicle Tires
Qingdao Sentury Tire Co., Ltd.	SENTURY	Light Duty Vehicle Tires
Qingdao Sentury Tire Co., Ltd.	SpeedMax	Medium and Heavy Duty Vehicle Tires
Qingdao Sentury Tire Co., Ltd.	SURETRAC	Medium and Heavy Duty Vehicle Tires
Qingdao Sentury Tire Co., Ltd.	SURETRAC	Light Duty Vehicle Tires
Qingdao Sentury Tire Co., Ltd.	TRANSMAX	Light Duty Vehicle Tires
Qingdao Sentury Tire Co., Ltd.	TRANSMAX	Medium and Heavy Duty Vehicle Tires
Qingdao Sentury Tire Co., Ltd.	TYFOON	Light Duty Vehicle Tires
Qingdao Sentury Tire Co., Ltd.	VANDERBILT	Light Duty Vehicle Tires
Qingdao Sentury Tire Co., Ltd.	VELOZZA	Light Duty Vehicle Tires
Qingdao Sentury Tire Co., Ltd.	VENEZIA	Light Duty Vehicle Tires
Qingdao Sentury Tire Co., Ltd.	VERCELLI	Light Duty Vehicle Tires
Qingdao Sentury Tire Co., Ltd.	Vercelli II	Light Duty Vehicle Tires
Qingdao Sentury Tire Co., Ltd.	Vercelli IV	Light Duty Vehicle Tires
Qingdao Sentury Tire Co., Ltd.	Wild Spirit	Light Duty Vehicle Tires
Qingdao Sentury Tire Co., Ltd.	ZEETEX	Light Duty Vehicle Tires
Qingdao Sentury Tire Co., Ltd.	ZETA	Medium and Heavy Duty Vehicle Tires
Qingdao Sentury Tire Co., Ltd.	ZETA	Light Duty Vehicle Tires
Sailun Group Co., Ltd.	Blackhawk	Light Duty Vehicle Tires
Sailun Group Co., Ltd.	Blackhawk	Medium Duty and Heavy Duty Vehicle Tires
Sailun Group Co., Ltd.	Dynamo	Light Duty Vehicle Tires
Sailun Group Co., Ltd.	Dynamo	Medium Duty and Heavy Duty Vehicle Tires
Sailun Group Co., Ltd.	Ironhead	Light Duty Vehicle Tires
Sailun Group Co., Ltd.	Ironhead	Medium Duty and Heavy Duty Vehicle Tires
Sailun Group Co., Ltd.	Maxam	Medium Duty and Heavy Duty Vehicle Tires
Sailun Group Co., Ltd.	Private brand	Light Duty Vehicle Tires
Sailun Group Co., Ltd.	Private brand	Light Duty Vehicle Tires
Sailun Group Co., Ltd.	Private brand	Light Duty Vehicle Tires

Responsible Entity Name	Brand/Trade Name	Tire Type
Sumitomo Rubber Industries, Ltd.	Ohtsu	Medium Duty and Heavy Duty Vehicle Tires
Sumitomo Rubber Industries, Ltd.	Ohtsu	Light Duty Vehicle Tires
Sumitomo Rubber Industries, Ltd.	Sumitomo	Light Duty Vehicle Tires
Sumitomo Rubber Industries, Ltd.	Sumitomo	Medium Duty and Heavy Duty Vehicle Tires
Sumitomo Rubber Industries, Ltd.	Trailcutter AT4S	Light Duty Vehicle Tires
Sumitomo Rubber Industries, Ltd.	XTRRT	Light Duty Vehicle Tires
Tianjin Wanda Tyre Group Co., Ltd.	Air-Loc	Light Duty Vehicle Tires
Tianjin Wanda Tyre Group Co., Ltd.	All Star	Light Duty Vehicle Tires
Tianjin Wanda Tyre Group Co., Ltd.	Ameritrail	Light Duty Vehicle Tires
Tianjin Wanda Tyre Group Co., Ltd.	AMS	Light Duty Vehicle Tires
Tianjin Wanda Tyre Group Co., Ltd.	Antego	Light Duty Vehicle Tires
Tianjin Wanda Tyre Group Co., Ltd.	Antego	Light Duty Vehicle Tires
Tianjin Wanda Tyre Group Co., Ltd.	Black Trail	Light Duty Vehicle Tires
Tianjin Wanda Tyre Group Co., Ltd.	Caddie Master	Light Duty Vehicle Tires
Tianjin Wanda Tyre Group Co., Ltd.	Caraway	Light Duty Vehicle Tires
Tianjin Wanda Tyre Group Co., Ltd.	Dewostone	Light Duty Vehicle Tires
Tianjin Wanda Tyre Group Co., Ltd.	Eco Trail ST	Light Duty Vehicle Tires
Tianjin Wanda Tyre Group Co., Ltd.	EFX	Light Duty Vehicle Tires
Tianjin Wanda Tyre Group Co., Ltd.	Elevate STR	Light Duty Vehicle Tires
Tianjin Wanda Tyre Group Co., Ltd.	Evolution	Light Duty Vehicle Tires
Tianjin Wanda Tyre Group Co., Ltd.	Excel	Light Duty Vehicle Tires
Tianjin Wanda Tyre Group Co., Ltd.	Free Country	Light Duty Vehicle Tires
Tianjin Wanda Tyre Group Co., Ltd.	Golbaltrax	Light Duty Vehicle Tires
Tianjin Wanda Tyre Group Co., Ltd.	Goldenwest	Light Duty Vehicle Tires
Tianjin Wanda Tyre Group Co., Ltd.	Golfproplus	Light Duty Vehicle Tires
Tianjin Wanda Tyre Group Co., Ltd.	Hakuba	Light Duty Vehicle Tires
Tianjin Wanda Tyre Group Co., Ltd.	HI-RUN	Light Duty Vehicle Tires
Tianjin Wanda Tyre Group Co., Ltd.	Interco	Light Duty Vehicle Tires
Tianjin Wanda Tyre Group Co., Ltd.	Jet Star	Light Duty Vehicle Tires
Tianjin Wanda Tyre Group Co., Ltd.	Jimexs	Light Duty Vehicle Tires
Tianjin Wanda Tyre Group Co., Ltd.	Journey	Light Duty Vehicle Tires
Tianjin Wanda Tyre Group Co., Ltd.	K9	Light Duty Vehicle Tires
Tianjin Wanda Tyre Group Co., Ltd.	LSI Elite	Light Duty Vehicle Tires
Tianjin Wanda Tyre Group Co., Ltd.	Maxauto	Light Duty Vehicle Tires
Tianjin Wanda Tyre Group Co., Ltd.	Milestar	Light Duty Vehicle Tires
Tianjin Wanda Tyre Group Co., Ltd.	Modz	Light Duty Vehicle Tires
Tianjin Wanda Tyre Group Co., Ltd.	Nanco	Light Duty Vehicle Tires
Tianjin Wanda Tyre Group Co., Ltd.	Obor	Light Duty Vehicle Tires
Tianjin Wanda Tyre Group Co., Ltd.	Ocelot	Light Duty Vehicle Tires
Tianjin Wanda Tyre Group Co., Ltd.	OTR	Light Duty Vehicle Tires
Tianjin Wanda Tyre Group Co., Ltd.	Power King	Light Duty Vehicle Tires
Tianjin Wanda Tyre Group Co., Ltd.	Primex	Light Duty Vehicle Tires
Tianjin Wanda Tyre Group Co., Ltd.	Quadboss	Light Duty Vehicle Tires
Tianjin Wanda Tyre Group Co., Ltd.	Rainier ST	Light Duty Vehicle Tires
Tianjin Wanda Tyre Group Co., Ltd.	RHOX	Light Duty Vehicle Tires
Tianjin Wanda Tyre Group Co., Ltd.	Rubbermaster	Light Duty Vehicle Tires
Tianjin Wanda Tyre Group Co., Ltd.	Slingshotxt	Light Duty Vehicle Tires
Tianjin Wanda Tyre Group Co., Ltd.	Speedutv	Light Duty Vehicle Tires
Tianjin Wanda Tyre Group Co., Ltd.	Steeleng	Light Duty Vehicle Tires
Tianjin Wanda Tyre Group Co., Ltd.	Super Grip	Light Duty Vehicle Tires
Tianjin Wanda Tyre Group Co., Ltd.	Synergy	Light Duty Vehicle Tires
Tianjin Wanda Tyre Group Co., Ltd.	Tex Star	Light Duty Vehicle Tires
Tianjin Wanda Tyre Group Co., Ltd.	Trac Gard	Light Duty Vehicle Tires
Tianjin Wanda Tyre Group Co., Ltd.	Trailfinder	Light Duty Vehicle Tires
Tianjin Wanda Tyre Group Co., Ltd.	Trailquest	Light Duty Vehicle Tires
Tianjin Wanda Tyre Group Co., Ltd.	Traxion	Light Duty Vehicle Tires
Tianjin Wanda Tyre Group Co., Ltd.	Tread-Star	Light Duty Vehicle Tires
Tianjin Wanda Tyre Group Co., Ltd.	Tusk	Light Duty Vehicle Tires
Tianjin Wanda Tyre Group Co., Ltd.	Vision	Light Duty Vehicle Tires
Tianjin Wanda Tyre Group Co., Ltd.	Wanda	Light Duty Vehicle Tires
Tianjin Wanda Tyre Group Co., Ltd.	WD-Signature	Light Duty Vehicle Tires
Tianjin Wanda Tyre Group Co., Ltd.	WDT	Light Duty Vehicle Tires
Tianjin Wanda Tyre Group Co., Ltd.	WD-Velocity	Light Duty Vehicle Tires
Tianjin Wanda Tyre Group Co., Ltd.	Wolfpack	Light Duty Vehicle Tires

Responsible Entity Name	Brand/Trade Name	Tire Type
Tianjin Wanda Tyre Group Co., Ltd.	Zeemax	Light Duty Vehicle Tires
The Goodyear Tire & Rubber Company	ARIZONIAN	Light Duty Vehicle Tires
The Goodyear Tire & Rubber Company	Avon	Light Duty Vehicle Tires
The Goodyear Tire & Rubber Company	Avon	Motorcycle Tires
The Goodyear Tire & Rubber Company	Beltak	Retread
The Goodyear Tire & Rubber Company	BIG O	Light Duty Vehicle Tires
The Goodyear Tire & Rubber Company	Blackstone	Light Duty Vehicle Tires
The Goodyear Tire & Rubber Company	BLUE STREAK TBA 8	Light Duty Vehicle Tires
The Goodyear Tire & Rubber Company	BLUE STREAK TBA 9	Light Duty Vehicle Tires
The Goodyear Tire & Rubber Company	BLUE STREAK-BLSTRK	Light Duty Vehicle Tires
The Goodyear Tire & Rubber Company	BLUE STREAK-GDYR	Light Duty Vehicle Tires
The Goodyear Tire & Rubber Company	Centara	Light Duty Vehicle Tires
The Goodyear Tire & Rubber Company	Cooper	Light Duty Vehicle Tires
The Goodyear Tire & Rubber Company	Cooper	Light Duty Vehicle Tires
The Goodyear Tire & Rubber Company	Cooper	Medium Duty and Heavy Duty Vehicle Tires
The Goodyear Tire & Rubber Company	Dean	Light Duty Vehicle Tires
The Goodyear Tire & Rubber Company	Dean	Medium Duty and Heavy Duty Vehicle Tires
The Goodyear Tire & Rubber Company	Dean PB	Light Duty Vehicle Tires
The Goodyear Tire & Rubber Company	Debica	Light Duty Vehicle Tires
The Goodyear Tire & Rubber Company	Debica	Medium Duty and Heavy Duty Vehicle Tires
The Goodyear Tire & Rubber Company	Debica	Medium Duty and Heavy Duty Vehicle Tires
The Goodyear Tire & Rubber Company	Diamondback	Light Duty Vehicle Tires
The Goodyear Tire & Rubber Company	Diplomat	Light Duty Vehicle Tires
The Goodyear Tire & Rubber Company	Douglas	Light Duty Vehicle Tires
The Goodyear Tire & Rubber Company	Dunlop	Light Duty Vehicle Tires
The Goodyear Tire & Rubber Company	Dunlop	Medium Duty and Heavy Duty Vehicle Tires
The Goodyear Tire & Rubber Company	Dunlop	Motorcycle Tires
The Goodyear Tire & Rubber Company	Dunlop	Light Duty Vehicle Tires
The Goodyear Tire & Rubber Company	Dunlop	Medium Duty and Heavy Duty Vehicle Tires
The Goodyear Tire & Rubber Company	Dunlop	Motorcycle Tires
The Goodyear Tire & Rubber Company	Durun	Light Duty Vehicle Tires
The Goodyear Tire & Rubber Company	Falke	Light Duty Vehicle Tires
The Goodyear Tire & Rubber Company	Fulda	Light Duty Vehicle Tires
The Goodyear Tire & Rubber Company	Fulda	Medium Duty and Heavy Duty Vehicle Tires
The Goodyear Tire & Rubber Company	Fulda	Light Duty Vehicle Tires
The Goodyear Tire & Rubber Company	Futura	Light Duty Vehicle Tires
The Goodyear Tire & Rubber Company	Geotred	Light Duty Vehicle Tires
The Goodyear Tire & Rubber Company	Geotred	Light Duty Vehicle Tires
The Goodyear Tire & Rubber Company	Goodyear	Light Duty Vehicle Tires
The Goodyear Tire & Rubber Company	Goodyear	Medium Duty and Heavy Duty Vehicle Tires
The Goodyear Tire & Rubber Company	Goodyear	Retread
The Goodyear Tire & Rubber Company	Hercules	Light Duty Vehicle Tires
The Goodyear Tire & Rubber Company	Ironman	Light Duty Vehicle Tires
The Goodyear Tire & Rubber Company	Kelly	Medium Duty and Heavy Duty Vehicle Tires
The Goodyear Tire & Rubber Company	Kelly	Light Duty Vehicle Tires
The Goodyear Tire & Rubber Company	Kelly	Medium Duty and Heavy Duty Vehicle Tires
The Goodyear Tire & Rubber Company	Lemans	Light Duty Vehicle Tires
The Goodyear Tire & Rubber Company	Lexington	Light Duty Vehicle Tires
The Goodyear Tire & Rubber Company	Loadrunner	Medium Duty and Heavy Duty Vehicle Tires
The Goodyear Tire & Rubber Company	Mastercraft	Light Duty Vehicle Tires
The Goodyear Tire & Rubber Company	Mastercraft	Medium Duty and Heavy Duty Vehicle Tires
The Goodyear Tire & Rubber Company	Mickey Thompson	Light Duty Vehicle Tires
The Goodyear Tire & Rubber Company	Mickey Thompson	Medium Duty and Heavy Duty Vehicle Tires
The Goodyear Tire & Rubber Company	Mickey Thompson	Light Duty Vehicle Tires
The Goodyear Tire & Rubber Company	Motomaster	Light Duty Vehicle Tires
The Goodyear Tire & Rubber Company	Motrio	Light Duty Vehicle Tires
The Goodyear Tire & Rubber Company	Non-core brand	Light Duty Vehicle Tires
The Goodyear Tire & Rubber Company	O'Green	Medium Duty and Heavy Duty Vehicle Tires
The Goodyear Tire & Rubber Company	Omega	Light Duty Vehicle Tires
The Goodyear Tire & Rubber Company	Provato	Light Duty Vehicle Tires
The Goodyear Tire & Rubber Company	Remington	Medium Duty and Heavy Duty Vehicle Tires
The Goodyear Tire & Rubber Company	Remington	Medium Duty and Heavy Duty Vehicle Tires
The Goodyear Tire & Rubber Company	Roadmaster	Medium Duty and Heavy Duty Vehicle Tires
The Goodyear Tire & Rubber Company	Roadstone	Light Duty Vehicle Tires

Responsible Entity Name	Brand/Trade Name	Tire Type
The Goodyear Tire & Rubber Company	Sava	Light Duty Vehicle Tires
The Goodyear Tire & Rubber Company	Sava	Medium Duty and Heavy Duty Vehicle Tires
The Goodyear Tire & Rubber Company	Sava	Medium Duty and Heavy Duty Vehicle Tires
The Goodyear Tire & Rubber Company	Sava	Light Duty Vehicle Tires
The Goodyear Tire & Rubber Company	Starfire	Light Duty Vehicle Tires
The Goodyear Tire & Rubber Company	Starfire	Medium Duty and Heavy Duty Vehicle Tires
The Goodyear Tire & Rubber Company	Steelmark	Medium Duty and Heavy Duty Vehicle Tires
The Goodyear Tire & Rubber Company	Ultima	Retread
Toyo Tire Holdings of Americas Inc.	ARCTIC CLAW	Light Duty Vehicle Tires
Toyo Tire Holdings of Americas Inc.	BIG O	Light Duty Vehicle Tires
Toyo Tire Holdings of Americas Inc.	FIRESTONE	Light Duty Vehicle Tires
Toyo Tire Holdings of Americas Inc.	IRONMAN	Light Duty Vehicle Tires
Toyo Tire Holdings of Americas Inc.	NITTO	Light Duty Vehicle Tires
Toyo Tire Holdings of Americas Inc.	ROAD HUGGER	Light Duty Vehicle Tires
Toyo Tire Holdings of Americas Inc.	TOYO	Light Duty Vehicle Tires
Toyo Tire Holdings of Americas Inc.	TOYO	Medium and Heavy Duty Vehicle Tires
Triangle Tyre Co., Ltd	DIAMONDBACK	Special Tyre for Trailer
Triangle Tyre Co., Ltd	DIAMONDBACK	Passenger Car Radial Tyres
Triangle Tyre Co., Ltd	DIAMONDBACK	Light Truck Tyres
Triangle Tyre Co., Ltd	DIAMONDBACK	Truck-Bus
Triangle Tyre Co., Ltd	TRIANGLE	Truck-Bus
Triangle Tyre Co., Ltd	TRIANGLE	Special Tyre for Trailer
Triangle Tyre Co., Ltd	TRIANGLE	Passenger Car Radial Tyres
Triangle Tyre Co., Ltd	TRIANGLE	Light Truck Tyres
Yokohama Tire Corporation	Galaxy	Medium Duty and Heavy Duty Vehicle Tires
Yokohama Tire Corporation	Yokohama	Light Duty Vehicle Tires
Yokohama Tire Corporation	Yokohama	Medium Duty and Heavy Duty Vehicle Tires
Yokohama TWS North America, Inc.	Mitas	Motorcycle Tires
ZC Rubber America Inc.	ADVANTA	Passenger Car Tires
ZC Rubber America Inc.	ADVANTA	Light Truck Tires
ZC Rubber America Inc.	ADVANTA	Medium Truck Tires
ZC Rubber America Inc.	AMERICAN TOURER	Passenger Car Tires
ZC Rubber America Inc.	AMERICAN TOURER	Light Truck Tires
ZC Rubber America Inc.	AMERICAN TOURER	Medium Truck Tires
ZC Rubber America Inc.	AMERICUS	Passenger Car Tires
ZC Rubber America Inc.	AMERICUS	Light Truck Tires
ZC Rubber America Inc.	AMERICUS	Medium Truck Tires
ZC Rubber America Inc.	AMP	Passenger Car Tires
ZC Rubber America Inc.	AMP	Light Truck Tires
ZC Rubber America Inc.	AMP	Medium Truck Tires
ZC Rubber America Inc.	ANGLER	Passenger Car Tires
ZC Rubber America Inc.	ANGLER	Light Truck Tires
ZC Rubber America Inc.	ANGLER	Medium Truck Tires
ZC Rubber America Inc.	ARISUN	Passenger Car Tires
ZC Rubber America Inc.	ARISUN	Light Truck Tires
ZC Rubber America Inc.	ARISUN	Medium Truck Tires
ZC Rubber America Inc.	ARISUN	Motorcycle Tires
ZC Rubber America Inc.	BISON	Passenger Car Tires
ZC Rubber America Inc.	BISON	Light Truck Tires
ZC Rubber America Inc.	BISON	Medium Truck Tires
ZC Rubber America Inc.	BULL	Passenger Car Tires
ZC Rubber America Inc.	BULL	Light Truck Tires
ZC Rubber America Inc.	BULL	Medium Truck Tires
ZC Rubber America Inc.	CASTLE ROCK	Light Truck Tires
ZC Rubber America Inc.	CASTLE ROCK	Medium Truck Tires
ZC Rubber America Inc.	CAVALRY	Passenger Car Tires
ZC Rubber America Inc.	CAVALRY	Light Truck Tires
ZC Rubber America Inc.	CAVALRY	Medium Truck Tires
ZC Rubber America Inc.	CHAOYANG	Passenger Car Tires
ZC Rubber America Inc.	CHAOYANG	Light Truck Tires
ZC Rubber America Inc.	CHAOYANG	Medium Truck Tires
ZC Rubber America Inc.	CHAOYANG	Motorcycle Tires
ZC Rubber America Inc.	COSMO	Passenger Car Tires
ZC Rubber America Inc.	COSMO	Light Truck Tires

Responsible Entity Name	Brand/Trade Name	Tire Type
ZC Rubber America Inc.	COSMO	Medium Truck Tires
ZC Rubber America Inc.	DCENTI	Passenger Car Tires
ZC Rubber America Inc.	DCENTI	Light Truck Tires
ZC Rubber America Inc.	DCENTI	Medium Truck Tires
ZC Rubber America Inc.	DIDAR	Passenger Car Tires
ZC Rubber America Inc.	DIDAR	Light Truck Tires
ZC Rubber America Inc.	DIDAR	Medium Truck Tires
ZC Rubber America Inc.	DORAL	Passenger Car Tires
ZC Rubber America Inc.	DORAL	Light Truck Tires
ZC Rubber America Inc.	DORAL	Medium Truck Tires
ZC Rubber America Inc.	FINALIST	Passenger Car Tires
ZC Rubber America Inc.	FINALIST	Light Truck Tires
ZC Rubber America Inc.	FINALIST	Medium Truck Tires
ZC Rubber America Inc.	FORCELAND	Passenger Car Tires
ZC Rubber America Inc.	FORCELAND	Light Truck Tires
ZC Rubber America Inc.	FORCELAND	Medium Truck Tires
ZC Rubber America Inc.	FREEDOM HAULER	Passenger Car Tires
ZC Rubber America Inc.	FREEDOM HAULER	Light Truck Tires
ZC Rubber America Inc.	FREEDOM HAULER	Medium Truck Tires
ZC Rubber America Inc.	GOLDEN CROWN	Passenger Car Tires
ZC Rubber America Inc.	GOLDEN CROWN	Light Truck Tires
ZC Rubber America Inc.	GOLDEN CROWN	Medium Truck Tires
ZC Rubber America Inc.	GOODRIDE	Passenger Car Tires
ZC Rubber America Inc.	GOODRIDE	Light Truck Tires
ZC Rubber America Inc.	GOODRIDE	Medium Truck Tires
ZC Rubber America Inc.	GOODRIDE	Motorcycle Tires
ZC Rubber America Inc.	GREMAX	Passenger Car Tires
ZC Rubber America Inc.	GREMAX	Light Truck Tires
ZC Rubber America Inc.	GREMAX	Medium Truck Tires
ZC Rubber America Inc.	HERCULES	Passenger Car Tires
ZC Rubber America Inc.	HERCULES	Light Truck Tires
ZC Rubber America Inc.	HERCULES	Medium Truck Tires
ZC Rubber America Inc.	HI-RUN	Passenger Car Tires
ZC Rubber America Inc.	HI-RUN	Light Truck Tires
ZC Rubber America Inc.	HI-RUN	Medium Truck Tires
ZC Rubber America Inc.	IRONMAN	Passenger Car Tires
ZC Rubber America Inc.	IRONMAN	Light Truck Tires
ZC Rubber America Inc.	IRONMAN	Medium Truck Tires
ZC Rubber America Inc.	MAGNA	Passenger Car Tires
ZC Rubber America Inc.	MAGNA	Light Truck Tires
ZC Rubber America Inc.	MAGNA	Medium Truck Tires
ZC Rubber America Inc.	MASTERTRACK	Passenger Car Tires
ZC Rubber America Inc.	MASTERTRACK	Light Truck Tires
ZC Rubber America Inc.	MASTERTRACK	Medium Truck Tires
ZC Rubber America Inc.	MILESTAR	Passenger Car Tires
ZC Rubber America Inc.	MILESTAR	Light Truck Tires
ZC Rubber America Inc.	MILESTAR	Medium Truck Tires
ZC Rubber America Inc.	MRT	Passenger Car Tires
ZC Rubber America Inc.	MRT	Light Truck Tires
ZC Rubber America Inc.	MRT	Medium Truck Tires
ZC Rubber America Inc.	NIPON	Passenger Car Tires
ZC Rubber America Inc.	NIPON	Light Truck Tires
ZC Rubber America Inc.	NIPON	Medium Truck Tires
ZC Rubber America Inc.	ORNATE	Passenger Car Tires
ZC Rubber America Inc.	ORNATE	Light Truck Tires
ZC Rubber America Inc.	ORNATE	Medium Truck Tires
ZC Rubber America Inc.	RADAR	Passenger Car Tires
ZC Rubber America Inc.	RADAR	Light Truck Tires
ZC Rubber America Inc.	RADAR	Medium Truck Tires
ZC Rubber America Inc.	RDR	Passenger Car Tires
ZC Rubber America Inc.	RDR	Light Truck Tires
ZC Rubber America Inc.	RDR	Medium Truck Tires
ZC Rubber America Inc.	RED FLAME	Passenger Car Tires
ZC Rubber America Inc.	RED FLAME	Light Truck Tires

Responsible Entity Name	Brand/Trade Name	Tire Type
ZC Rubber America Inc.	RED FLAME	Medium Truck Tires
ZC Rubber America Inc.	RISEN	Passenger Car Tires
ZC Rubber America Inc.	RISEN	Light Truck Tires
ZC Rubber America Inc.	RISEN	Medium Truck Tires
ZC Rubber America Inc.	SENTINEL	Passenger Car Tires
ZC Rubber America Inc.	SENTINEL	Light Truck Tires
ZC Rubber America Inc.	SENTINEL	Medium Truck Tires
ZC Rubber America Inc.	STERLING	Light Truck Tires
ZC Rubber America Inc.	STERLING	Medium Truck Tires
ZC Rubber America Inc.	SUPERCARGO	Passenger Car Tires
ZC Rubber America Inc.	SUPERCARGO	Light Truck Tires
ZC Rubber America Inc.	SUPERCARGO	Medium Truck Tires
ZC Rubber America Inc.	SUPERMAX	Passenger Car Tires
ZC Rubber America Inc.	SUPERMAX	Light Truck Tires
ZC Rubber America Inc.	SUPERMAX	Medium Truck Tires
ZC Rubber America Inc.	TAMARACK	Light Truck Tires
ZC Rubber America Inc.	TAMARACK	Medium Truck Tires
ZC Rubber America Inc.	TRAILFINDER	Passenger Car Tires
ZC Rubber America Inc.	TRAILFINDER	Light Truck Tires
ZC Rubber America Inc.	TRAILFINDER	Medium Truck Tires
ZC Rubber America Inc.	TRANSEAGLE	Passenger Car Tires
ZC Rubber America Inc.	TRANSEAGLE	Light Truck Tires
ZC Rubber America Inc.	TRANSEAGLE	Medium Truck Tires
ZC Rubber America Inc.	TRAVELSTAR	Passenger Car Tires
ZC Rubber America Inc.	TRAVELSTAR	Light Truck Tires
ZC Rubber America Inc.	TRAVELSTAR	Medium Truck Tires
ZC Rubber America Inc.	TRAZANO	Passenger Car Tires
ZC Rubber America Inc.	TRAZANO	Light Truck Tires
ZC Rubber America Inc.	TRAZANO	Medium Truck Tires
ZC Rubber America Inc.	TRAZANO	Motorcycle Tires
ZC Rubber America Inc.	VENOM POWER	Passenger Car Tires
ZC Rubber America Inc.	VENOM POWER	Light Truck Tires
ZC Rubber America Inc.	WESTLAKE	Passenger Car Tires
ZC Rubber America Inc.	WESTLAKE	Light Truck Tires
ZC Rubber America Inc.	WESTLAKE	Medium Truck Tires
ZC Rubber America Inc.	WESTLAKE	Motorcycle Tires
ZC Rubber America Inc.	YARTU	Passenger Car Tires
ZC Rubber America Inc.	YARTU	Light Truck Tires
ZC Rubber America Inc.	YARTU	Medium Truck Tires

Appendix C

SDS for Santoflex™ 6PPD Pastilles

Santoflex(TM) 6PPD Pastilles

Version Revision Date: SDS Number: Date of last issue: 04/28/2022
2.9 05/04/2022 150000093128 Date of first issue: 09/06/2016
PRD SDSUS / Z8 / 0528

SECTION 1. IDENTIFICATION

Product name : Santoflex(TM) 6PPD Pastilles

Product code : P3408704

Manufacturer or supplier's details

Company name of supplier : Flexsys Chemicals Belgium NV

Address : Scheldelaan 460, Haven 627
Antwerpen 2040

Emergency telephone : CHEMTREC: +1 703-741-5970

Recommended use of the chemical and restrictions on use

Recommended use : antioxidant (industrial)
Stabilizer

Restrictions on use : None known.

SECTION 2. HAZARDS IDENTIFICATION**GHS classification in accordance with the OSHA Hazard Communication Standard (29 CFR 1910.1200)**

Acute toxicity (Oral) : Category 4

Skin sensitization : Category 1

Reproductive toxicity : Category 1B

GHS label elements

Hazard pictograms :



Signal Word : Danger

Hazard Statements : H302 Harmful if swallowed.
H317 May cause an allergic skin reaction.
H360 May damage fertility or the unborn child.

Precautionary Statements : **Prevention:**
P201 Obtain special instructions before use.
P202 Do not handle until all safety precautions have been read
and understood.

Santoflex(TM) 6PPD Pastilles

Version	Revision Date:	SDS Number:	Date of last issue: 04/28/2022
2.9	05/04/2022	150000093128	Date of first issue: 09/06/2016
PRD		SDSUS / Z8 / 0528	

P261 Avoid breathing dust/ fume/ gas/ mist/ vapors/ spray.
 P264 Wash skin thoroughly after handling.
 P270 Do not eat, drink or smoke when using this product.
 P272 Contaminated work clothing should not be allowed out of the workplace.
 P280 Wear protective gloves/ protective clothing/ eye protection/ face protection.

Response:

P301 + P312 + P330 IF SWALLOWED: Call a POISON CENTER/ doctor if you feel unwell. Rinse mouth.
 P302 + P352 IF ON SKIN: Wash with plenty of soap and water.
 P308 + P313 IF exposed or concerned: Get medical advice/ attention.
 P333 + P313 If skin irritation or rash occurs: Get medical advice/ attention.
 P363 Wash contaminated clothing before reuse.

Storage:

P405 Store locked up.

Disposal:

P501 Dispose of contents/ container to an approved waste disposal plant.

Other hazards

None known.

SECTION 3. COMPOSITION/INFORMATION ON INGREDIENTS

Substance / Mixture : Substance
 Substance name : N-(1,3-Dimethylbutyl)-N'-phenyl-p-phenylenediamine
 CAS-No. : 793-24-8

Components

Chemical name	CAS-No.	Concentration (% w/w)
N-1,3-Dimethylbutyl-N'-phenyl-p-phenylenediamine	793-24-8	>= 95 - <= 100

Actual concentration is withheld as a trade secret

Flexsys is committed to the safety, health and environment of our employees, our customers, and the communities we operate within. As part of this commitment, Flexsys' Safety Data Sheets (SDS) are prepared in accordance with all applicable national and local regulations. The compositions of our documents reflect these requirements which include, but are not limited to, requirements under the Globally Harmonized System of Classification and Labeling (GHS). These compositions commonly involve the use of ranges versus specific analytical values. If you require a composition that is more specific, please refer to the Certificate of Analysis, sales specification, or contact your Customer Service Representative.

Santoflex(TM) 6PPD Pastilles

Version	Revision Date:	SDS Number:	Date of last issue: 04/28/2022
2.9	05/04/2022	15000093128	Date of first issue: 09/06/2016
PRD		SDSUS / Z8 / 0528	

SECTION 4. FIRST AID MEASURES

- If inhaled : Remove person to fresh air and keep comfortable for breathing.
If breathing is difficult, give oxygen.
Consult a physician if necessary.
- In case of skin contact : Wash off immediately with soap and plenty of water while removing all contaminated clothes and shoes.
If skin irritation or rash occurs: Get medical advice/ attention.
Wash contaminated clothing before reuse.
- In case of eye contact : In case of contact, immediately flush eyes with plenty of water for at least 15 minutes.
Get medical attention if symptoms occur.
- If swallowed : Rinse mouth.
Get medical attention if symptoms occur.
Do not induce vomiting unless directed to do so by medical personnel.
Never give anything by mouth to an unconscious person.
- Most important symptoms and effects, both acute and delayed : Harmful if swallowed.
May cause an allergic skin reaction.
May damage fertility or the unborn child.
- Notes to physician : Treat symptomatically.

SECTION 5. FIRE-FIGHTING MEASURES

- Suitable extinguishing media : Water spray
Foam
Dry powder
Carbon dioxide (CO₂)
- Unsuitable extinguishing media : Do not use a solid water stream as it may scatter and spread fire.
- Specific hazards during fire fighting : Do not allow run-off from fire fighting to enter drains or water courses.
- Hazardous combustion products : Carbon oxides
Nitrogen oxides (NO_x)
- Further information : In case of fire and/or explosion do not breathe fumes.
- Special protective equipment for fire-fighters : Wear an approved positive pressure self-contained breathing apparatus in addition to standard fire fighting gear.

SECTION 6. ACCIDENTAL RELEASE MEASURES

- Personal precautions, protection : Wear appropriate personal protective equipment.

Santoflex(TM) 6PPD Pastilles

Version	Revision Date:	SDS Number:	Date of last issue: 04/28/2022
2.9	05/04/2022	150000093128	Date of first issue: 09/06/2016
PRD		SDSUS / Z8 / 0528	

tive equipment and emergency procedures

Avoid prolonged or repeated contact with skin.
 Avoid breathing dust/ fume/ gas/ mist/ vapors/ spray.
 Ensure adequate ventilation.
 Material can create slippery conditions.
 Local authorities should be advised if significant spillages cannot be contained.

Environmental precautions : Prevent further leakage or spillage if safe to do so.
 Avoid release to the environment.
 Collect spillage.

Methods and materials for containment and cleaning up : Sweep up and shovel into suitable containers for disposal.

SECTION 7. HANDLING AND STORAGE

Advice on safe handling : Wear appropriate personal protective equipment.
 Avoid breathing dust/ fume/ gas/ mist/ vapors/ spray.
 Handle product only in closed system or provide appropriate exhaust ventilation at machinery.
 Drain or remove substance from equipment prior to break-in or maintenance.
 Wash thoroughly after handling.
 Do not eat, drink or smoke when using this product.
 Contaminated work clothing should not be allowed out of the workplace.

Conditions for safe storage : Keep containers tightly closed in a dry, cool and well-ventilated place.

SECTION 8. EXPOSURE CONTROLS/PERSONAL PROTECTION

Ingredients with workplace control parameters

Contains no substances with occupational exposure limit values.

Engineering measures : Good general ventilation (typically 10 air changes per hour) should be used. Ventilation rates should be matched to conditions. If applicable, use process enclosures, local exhaust ventilation, or other engineering controls to maintain airborne levels below recommended exposure limits. If exposure limits have not been established, maintain airborne levels to an acceptable level.

Personal protective equipment

Respiratory protection : Use a properly fitted, particulate filter respirator complying with an approved standard if a risk assessment indicates this is necessary.
 Respirator selection, use, and maintenance must be in accordance with regulatory requirements, if applicable.
 If engineering controls do not maintain airborne concentrations below recommended exposure limits (where

Santoflex(TM) 6PPD Pastilles

Version	Revision Date:	SDS Number:	Date of last issue: 04/28/2022
2.9	05/04/2022	150000093128	Date of first issue: 09/06/2016
PRD		SDSUS / Z8 / 0528	

applicable) or to an acceptable level (in countries where exposure limits have not been established), an approved respirator must be worn.

Hand protection

Remarks : For prolonged or repeated contact use protective gloves. After contamination with product change the gloves immediately and dispose of them according to relevant national and local regulations.

Eye protection

: Safety eyewear complying with an approved standard should be used when a risk assessment indicates this is necessary to avoid exposure to liquid splashes, mists, gases or dusts. Wear safety glasses with side shields (or goggles).

Skin and body protection

: Personal protective equipment for the body should be selected based on the task being performed and the risks involved and should be approved by a specialist before handling this product.
Remove and wash contaminated clothing before re-use.

Protective measures

: Ensure that eye flushing systems and safety showers are located close to the working place.

SECTION 9. PHYSICAL AND CHEMICAL PROPERTIES

Appearance	:	Pastilles
Color	:	purple, brown
Odor	:	aromatic
Odor Threshold	:	not determined
pH	:	not determined
Melting point/range	:	120 °F / 49 °C (1,013 hPa)
Boiling point/boiling range	:	325 - 329 °F / 163 - 165 °C (1.33 hPa)
Flash point	:	396 °F / 202 °C (1,013 hPa) Method: Pensky-Martens closed cup
Evaporation rate	:	not determined
Flammability (solid, gas)	:	Not classified as hazardous.

Santoflex(TM) 6PPD Pastilles

Version	Revision Date:	SDS Number:	Date of last issue: 04/28/2022
2.9	05/04/2022	150000093128	Date of first issue: 09/06/2016
PRD		SDSUS / Z8 / 0528	

Upper explosion limit / Upper flammability limit : not determined

Vapor pressure : 0.000036 hPa (77 °F / 25 °C)

Relative vapor density : not determined

Relative density : 0.995 (122 °F / 50 °C)

Density : 995 kg/m³ (122 °F / 50 °C)

Solubility(ies)

 Water solubility : 0.001 g/l (122 °F / 50 °C)

 Solubility in other solvents : soluble
 Solvent: Hydrocarbons

Partition coefficient: n-octanol/water : log Pow: 4.68 (68 °F / 20 °C)

Autoignition temperature : 1022 °F / 550 °C
Method: VDI 2263 Blatt 1 2.6
Dust

Decomposition temperature : > 392 °F / > 200 °C

Viscosity

 Viscosity, kinematic : not determined

Explosive properties : Not classified

Oxidizing properties : Not classified

Molecular weight : 268.44 g/mol

SECTION 10. STABILITY AND REACTIVITY

Reactivity : None reasonably foreseeable.

Chemical stability : Stable under normal conditions.

Possibility of hazardous reactions : None known.

Conditions to avoid : Heating in air.

Incompatible materials : Strong oxidizing agents

Hazardous decomposition products : Emits acrid smoke and fumes when heated to decomposition.

Santoflex(TM) 6PPD Pastilles

Version	Revision Date:	SDS Number:	Date of last issue: 04/28/2022
2.9	05/04/2022	150000093128	Date of first issue: 09/06/2016
PRD		SDSUS / Z8 / 0528	

SECTION 11. TOXICOLOGICAL INFORMATION**Acute toxicity**

Harmful if swallowed.

Product:

Acute oral toxicity : LD50 Oral (Rat): 893 mg/kg

Acute dermal toxicity : LD50 Dermal (Rabbit): > 7,940 mg/kg

Components:**N-1,3-Dimethylbutyl-N'-phenyl-p-phenylenediamine:**

Acute oral toxicity : LD50 Oral (Rat): 893 mg/kg

Acute dermal toxicity : LD50 Dermal (Rabbit): > 7,940 mg/kg

Skin corrosion/irritation

Not classified based on available information.

Product:

Species	:	Rabbit
Exposure time	:	72 h
Result	:	No skin irritation

Components:**N-1,3-Dimethylbutyl-N'-phenyl-p-phenylenediamine:**

Species	:	Rabbit
Exposure time	:	72 h
Result	:	No skin irritation

Serious eye damage/eye irritation

Not classified based on available information.

Product:

Species	:	Rabbit
Result	:	slight
Exposure time	:	72 h

Components:**N-1,3-Dimethylbutyl-N'-phenyl-p-phenylenediamine:**

Species	:	Rabbit
Result	:	slight
Exposure time	:	72 h

Santoflex(TM) 6PPD Pastilles

Version	Revision Date:	SDS Number:	Date of last issue: 04/28/2022
2.9	05/04/2022	150000093128	Date of first issue: 09/06/2016
PRD		SDSUS / Z8 / 0528	

Respiratory or skin sensitization**Skin sensitization**

May cause an allergic skin reaction.

Respiratory sensitization

Not classified based on available information.

Product:

Test Type	:	Skin sensitization
Species	:	Guinea pig
Result	:	May cause sensitization by skin contact.

Test Type	:	Human experience
Result	:	May cause sensitization by skin contact.

Components:**N-1,3-Dimethylbutyl-N'-phenyl-p-phenylenediamine:**

Test Type	:	Skin sensitization
Species	:	Guinea pig
Result	:	May cause sensitization by skin contact.

Test Type	:	Human experience
Result	:	May cause sensitization by skin contact.

Germ cell mutagenicity

Not classified based on available information.

Product:

Genotoxicity in vitro	:	Test Type: Mutagenicity - Bacterial
		Metabolic activation: +/- activation
		Method: Bacterial Reverse Mutation Assay
		Result: negative
		Metabolic activation: +/- activation
		Method: In vitro Mammalian Chromosome Aberration Test
		Result: positive
Genotoxicity in vivo	:	Test Type: various
		Species: Rat
		Result: negative

Components:**N-1,3-Dimethylbutyl-N'-phenyl-p-phenylenediamine:**

Genotoxicity in vitro	:	Test Type: Mutagenicity - Bacterial
		Metabolic activation: +/- activation
		Method: Bacterial Reverse Mutation Assay
		Result: negative

		Metabolic activation: +/- activation
		Method: In vitro Mammalian Chromosome Aberration Test

Santoflex(TM) 6PPD Pastilles

Version	Revision Date:	SDS Number:	Date of last issue: 04/28/2022
2.9	05/04/2022	150000093128	Date of first issue: 09/06/2016
PRD		SDSUS / Z8 / 0528	

Result: positive

Genotoxicity in vivo : Test Type: various
Species: Rat
Result: negative

Carcinogenicity

Not classified based on available information.

Product:

Species : Rat, male and female
Application Route : Ingestion
Method : OECD Test Guideline 451
Remarks : Based on available data, the classification criteria are not met.

Components:**N-1,3-Dimethylbutyl-N'-phenyl-p-phenylenediamine:**

Species : Rat, male and female
Application Route : Ingestion
Method : OECD Test Guideline 451
Remarks : Based on available data, the classification criteria are not met.

IARC No ingredient of this product present at levels greater than or equal to 0.1% is identified as probable, possible or confirmed human carcinogen by IARC.

OSHA No component of this product present at levels greater than or equal to 0.1% is on OSHA's list of regulated carcinogens.

NTP No ingredient of this product present at levels greater than or equal to 0.1% is identified as a known or anticipated carcinogen by NTP.

Reproductive toxicity

May damage fertility or the unborn child.

Product:

Effects on fertility : Species: Rat, male
Application Route: Oral
General Toxicity Parent: NOAEL: 60 mg/kg/day
General Toxicity F1: NOAEL: 60 mg/kg/day
Fertility: NOAEL: 60 mg/kg/day
Early Embryonic Development: NOAEL: 20 mg/kg/day
Method: OECD Test Guideline 443

Species: Rat, female
Application Route: Oral
General Toxicity Parent: NOAEL: 60 mg/kg/day
General Toxicity F1: NOAEL: 60 mg/kg/day
Fertility: NOAEL: 7 mg/kg/day
Early Embryonic Development: NOAEL: 20 mg/kg/day
Method: OECD Test Guideline 443

Santoflex(TM) 6PPD Pastilles

Version Revision Date: SDS Number: Date of last issue: 04/28/2022
2.9 05/04/2022 150000093128 Date of first issue: 09/06/2016
PRD SDSUS / Z8 / 0528

Product:

Not classified

Experience with human exposure**Product:**

Inhalation : Remarks: None known.
Skin contact : Remarks: May cause an allergic skin reaction.
Eye contact : Remarks: None known.
Ingestion : Remarks: Harmful if swallowed.

SECTION 12. ECOLOGICAL INFORMATION**Ecotoxicity****Components:****N-1,3-Dimethylbutyl-N'-phenyl-p-phenylenediamine:**

Toxicity to fish : LC50 (Oryzias latipes (Japanese medaka)): 0.028 mg/l
Exposure time: 96 h

Toxicity to daphnia and other : EC50 (Daphnia magna (Water flea)): 0.13 mg/l
aquatic invertebrates Exposure time: 48 h
Remarks: Read-across from a similar material

Toxicity to algae/aquatic : EC50 (Pseudokirchneriella subcapitata (green algae)): 0.335
plants mg/l
Exposure time: 72 h
Remarks: Read-across from a similar material

NOEC: 0.23 mg/l
Exposure time: 72 h
Remarks: Read-across from a similar material

Toxicity to fish (Chronic tox- : NOEC (Oryzias latipes (Japanese medaka)): 0.0037 mg/l
icity) Exposure time: 30 d

Toxicity to daphnia and other : NOEC (Daphnia magna (Water flea)): 0.007 mg/l
aquatic invertebrates (Chron- Exposure time: 21 d
ic toxicity) Remarks: Read-across from a similar material

Persistence and degradability**Components:****N-1,3-Dimethylbutyl-N'-phenyl-p-phenylenediamine:**

Biodegradability : Method: Ready Biodegradability: Modified MITI Test (I)
Remarks: Not readily biodegradable.

Santoflex(TM) 6PPD Pastilles

Version	Revision Date:	SDS Number:	Date of last issue: 04/28/2022
2.9	05/04/2022	150000093128	Date of first issue: 09/06/2016
PRD		SDSUS / Z8 / 0528	

Stability in water : Degradation half life: 2.9 h
Hydrolysis: at 24 °C

Bioaccumulative potential**Components:****N-1,3-Dimethylbutyl-N'-phenyl-p-phenylenediamine:**

Bioaccumulation : Bioconcentration factor (BCF): 569
Remarks: Bioaccumulation is unlikely.

Partition coefficient: n-octanol/water : log Pow: 4.68 (68 °F / 20 °C)

Mobility in soil**Components:****N-1,3-Dimethylbutyl-N'-phenyl-p-phenylenediamine:**

Distribution among environmental compartments : log Koc: 3.45
Method: QSAR model

Other adverse effects

No data available

SECTION 13. DISPOSAL CONSIDERATIONS**Disposal methods**

Waste from residues : Dispose of in accordance with local regulations.

SECTION 14. TRANSPORT INFORMATION**International Regulations****IATA-DGR**

UN/ID No. : UN 3077
Proper shipping name : Environmentally hazardous substance, solid, n.o.s.
(N-1,3-Dimethylbutyl-N'-phenyl-p-phenylenediamine)
Class : 9
Packing group : III
Labels : Miscellaneous
Packing instruction (cargo aircraft) : 956
Packing instruction (passenger aircraft) : 956

IMDG-Code

UN number : UN 3077
Proper shipping name : ENVIRONMENTALLY HAZARDOUS SUBSTANCE, SOLID,
N.O.S.
(N-1,3-Dimethylbutyl-N'-phenyl-p-phenylenediamine)

Santoflex(TM) 6PPD Pastilles

Version	Revision Date:	SDS Number:	Date of last issue: 04/28/2022
2.9	05/04/2022	150000093128	Date of first issue: 09/06/2016
PRD		SDSUS / Z8 / 0528	

Class	: 9
Packing group	: III
Labels	: 9
EmS Code	: F-A, S-F
Marine pollutant	: yes

Transport in bulk according to Annex II of MARPOL 73/78 and the IBC Code

Not applicable for product as supplied.

Domestic regulation

49 CFR

Not regulated as a dangerous good

Remarks : Shipping in package sizes of less than 5 L (liquids) or 5 KG (solids) may lead to a non-regulated classification.

Special precautions for user

Remarks : Shipping in package sizes of less than 5 L (liquids) or 5 KG (solids) may lead to a non-regulated classification.

The transport classification(s) provided herein are for informational purposes only, and solely based upon the properties of the unpackaged material as it is described within this Safety Data Sheet. Transportation classifications may vary by mode of transportation, package sizes, and variations in regional or country regulations.

SECTION 15. REGULATORY INFORMATION

CERCLA Reportable Quantity

This material does not contain any components with a CERCLA RQ.

SARA 304 Extremely Hazardous Substances Reportable Quantity

This material does not contain any components with a section 304 EHS RQ.

SARA 302 Extremely Hazardous Substances Threshold Planning Quantity

This material does not contain any components with a section 302 EHS TPQ.

SARA 311/312 Hazards : Respiratory or skin sensitization
 Reproductive toxicity
 Acute toxicity (any route of exposure)

SARA 313 : This material does not contain any chemical components with known CAS numbers that exceed the threshold (De Minimis) reporting levels established by SARA Title III, Section 313.

California Prop. 65

This product does not contain any chemicals known to the State of California to cause cancer, birth, or any other reproductive defects.

The ingredients of this product are reported in the following inventories:

TCSI : On the inventory, or in compliance with the inventory

TSCA : All substances listed as active on the TSCA inventory

Santoflex(TM) 6PPD Pastilles

Version	Revision Date:	SDS Number:	Date of last issue: 04/28/2022
2.9	05/04/2022	150000093128	Date of first issue: 09/06/2016
PRD		SDSUS / Z8 / 0528	

AIIC : On the inventory, or in compliance with the inventory

DSL : All components of this product are on the Canadian DSL

ENCS : On the inventory, or in compliance with the inventory

ISHL : On the inventory, or in compliance with the inventory

KECI : On the inventory, or in compliance with the inventory

PICCS : On the inventory, or in compliance with the inventory

IECSC : On the inventory, or in compliance with the inventory

NZIoC : On the inventory, or in compliance with the inventory

TECI : On the inventory, or in compliance with the inventory

TSCA list

No substances are subject to a Significant New Use Rule.

No substances are subject to TSCA 12(b) export notification requirements.

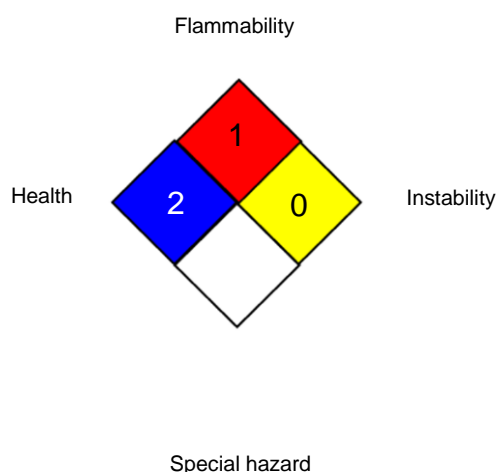
SECTION 16. OTHER INFORMATION**Further information****NFPA 704:****HMIS® IV:**

HEALTH	*	2
FLAMMABILITY		1
PHYSICAL HAZARD		0

HMIS® ratings are based on a 0-4 rating scale, with 0 representing minimal hazards or risks, and 4 representing significant hazards or risks. The "*" represents a chronic hazard, while the "/" represents the absence of a chronic hazard.

Full text of other abbreviations

AIIC - Australian Inventory of Industrial Chemicals; ASTM - American Society for the Testing of Materials; bw - Body weight; CERCLA - Comprehensive Environmental Response, Compensation,

Santoflex(TM) 6PPD Pastilles

Version	Revision Date:	SDS Number:	Date of last issue: 04/28/2022
2.9	05/04/2022	150000093128	Date of first issue: 09/06/2016
PRD		SDSUS / Z8 / 0528	

and Liability Act; CMR - Carcinogen, Mutagen or Reproductive Toxicant; DIN - Standard of the German Institute for Standardisation; DOT - Department of Transportation; DSL - Domestic Substances List (Canada); ECx - Concentration associated with x% response; EHS - Extremely Hazardous Substance; ELx - Loading rate associated with x% response; EmS - Emergency Schedule; ENCS - Existing and New Chemical Substances (Japan); ErCx - Concentration associated with x% growth rate response; ERG - Emergency Response Guide; GHS - Globally Harmonized System; GLP - Good Laboratory Practice; HMIS - Hazardous Materials Identification System; IARC - International Agency for Research on Cancer; IATA - International Air Transport Association; IBC - International Code for the Construction and Equipment of Ships carrying Dangerous Chemicals in Bulk; IC50 - Half maximal inhibitory concentration; ICAO - International Civil Aviation Organization; IECSC - Inventory of Existing Chemical Substances in China; IMDG - International Maritime Dangerous Goods; IMO - International Maritime Organization; ISHL - Industrial Safety and Health Law (Japan); ISO - International Organisation for Standardization; KECI - Korea Existing Chemicals Inventory; LC50 - Lethal Concentration to 50 % of a test population; LD50 - Lethal Dose to 50% of a test population (Median Lethal Dose); MARPOL - International Convention for the Prevention of Pollution from Ships; MSHA - Mine Safety and Health Administration; n.o.s. - Not Otherwise Specified; NFPA - National Fire Protection Association; NO(A)EC - No Observed (Adverse) Effect Concentration; NO(A)EL - No Observed (Adverse) Effect Level; NOELR - No Observable Effect Loading Rate; NTP - National Toxicology Program; NZIoC - New Zealand Inventory of Chemicals; OECD - Organization for Economic Co-operation and Development; OPPTS - Office of Chemical Safety and Pollution Prevention; PBT - Persistent, Bioaccumulative and Toxic substance; PICCS - Philippines Inventory of Chemicals and Chemical Substances; (Q)SAR - (Quantitative) Structure Activity Relationship; RCRA - Resource Conservation and Recovery Act; REACH - Regulation (EC) No 1907/2006 of the European Parliament and of the Council concerning the Registration, Evaluation, Authorisation and Restriction of Chemicals; RQ - Reportable Quantity; SADT - Self-Accelerating Decomposition Temperature; SARA - Superfund Amendments and Reauthorization Act; SDS - Safety Data Sheet; TCSI - Taiwan Chemical Substance Inventory; TECl - Thailand Existing Chemicals Inventory; TSCA - Toxic Substances Control Act (United States); UN - United Nations; UNRTDG - United Nations Recommendations on the Transport of Dangerous Goods; vPvB - Very Persistent and Very Bioaccumulative

Revision Date : 05/04/2022

The information provided in this Safety Data Sheet is correct to the best of our knowledge, information and belief at the date of its publication. The information given is designed only as a guidance for safe handling, use, processing, storage, transportation, disposal and release and is not to be considered a warranty or quality specification. The information relates only to the specific material designated and may not be valid for such material used in combination with any other materials or in any process, unless specified in the text.

US / Z8

Appendix D

Survey Concerning 6PPD Alternatives Sent to Consortium Members

Consortium Survey

Background

In order to assist the consortium in preparing an Alternative Analysis in California on behalf of the consortium members, the consortium members are required to respond to information surveys. Companies that joined the consortium when it was first formed have already completed this survey. We now ask that companies that have newly joined complete the survey as well.

The DTSC Safer Consumer Products Regulations define “alternative” to mean any of the following:

- “Removal of Chemical(s) of Concern from a Priority Product, with or without the use of one or more replacement chemicals;
- Reformulation or redesign of a Priority Product and/or manufacturing process to eliminate or reduce the concentration of Chemical(s) of Concern in the Priority Product;
- Redesign of a Priority Product and/or manufacturing process to reduce or restrict potential exposures to Chemical(s) of Concern in the Priority Product; or
- Any other change to a Priority Product or a manufacturing process that reduces the potential adverse impacts and/or potential exposures associated with the Chemical(s) of Concern in the Priority Product, and/or the potential adverse waste and end-of-life effects associated with the Priority Product.”

As part of the alternatives analysis process, the consortium is required to assess all aspects of the definition of alternative listed above. Since information regarding removal of 6PPD, reformulation, or redesign may be considered confidential business information, outside counsel is assisting us in collecting and aggregating information to ensure consortium member proprietary data and information remains confidential.

Individual company responses to survey questions, submitted to outside counsel, will not be shared with USTMA. Outside counsel will summarize the information received from companies and will then work with individual companies to obtain approval for the anonymized summary responses to each question. Summary, genericized responses will be shared with USTMA and consortium members.

Please provide responses to the survey questions below in Microsoft Word. **Please send your responses to [contact information] by [DUE DATE].** Please do not copy any USTMA staff on your response to outside counsel.

Categorizing Possible Alternatives

The Consortium Alternatives Analysis Working Group has identified a preliminary list of possible alternatives. The Working Group has also been working to identify and collect information regarding the performance and toxicity of these potential alternatives. Based on the information the working group was able to identify in the public domain regarding performance and toxicity, the working group has grouped possible alternatives into four categories (based on information regarding chemical performance):

1. Data/information confirms these chemicals are not suitable alternatives
2. Chemical structure confirms these chemicals are not suitable alternatives
3. Chemical structure of these chemicals indicates they may be possible alternatives but there is no performance or toxicity data/information to confirm
4. Chemical structure and initial data/information for these chemicals demonstrates they could be possible alternative

Survey Questions

For survey questions 1-4, please consult list of potential alternatives in responding to the questions below.

- 1) **Chemical Alternative Approach: An addition of a different chemical or chemicals in place of 6PPD.**
 - a. Category 3 and Category 4 may be possible alternatives. Please review the Category 3 and Category 4 chemicals listed in the attached. Category rankings are found in column I:
[Attachment containing list of chemicals under consideration from Gradient]
 - b. Please provide any data/information on chemicals on the alternatives list or related compounds that would change the conclusion of Category 3 or Category 4.
 - c. Please provide any data/information on chemicals that are on the alternatives list, or related compounds that would **support** the overall conclusion of Category 3 or Category 4.
 - d. Please provide any data/information on chemical toxicity of the chemicals on the alternatives list or related compounds that would change or support the overall conclusion of Category 3 or Category 4.
 - e. In general: If known, please provide any data/information on other chemical approaches that are a lower hazard, **available, functionally acceptable, and technically feasible** alternative that would eliminate the need for 6PPD.
- 2) **The Safer Consumer Products Regulations require the consortium to consider whether 6PPD can be removed from tires, with or without the use of one or more replacement chemicals.**
 - a. Please review the list of potential alternatives and add any additional chemicals that your company recommends the consortium consider as part of the alternatives analysis. Note, alternatives should have a lower hazard profile and should be functionally acceptable, technically feasible, and economically viable.
 - b. Does your company have any information/data that demonstrates that 6PPD can be removed from tires?
 - c. Please review the list of potential alternatives and provide any information that would change the categorization of the potential alternative.
 - d. For possible alternative chemicals that have the needed chemical structure and that have initial data/information on performance and/or toxicity which demonstrates these chemicals may be possible alternatives - please provide any additional information your company might have regarding performance and/or toxicity of these chemicals.

3) The Safer Consumer Products Regulations require the consortium to consider whether tires can be reformulated or redesigned to eliminate or reduce the concentration of 6PPD in tires.

- a. Please provide any data and/or information that your company has regarding the ability to reformulate tires to reduce the amount of 6PPD used in tread or sidewall (not including saturated polymers).
 - i. What worked? What did not work?
 - ii. Is it currently used in production or planned for future production? If planned for future production, what is the timing for that launch?
- b. Please provide any data/information on reformulation approaches using SATURATED polymers that reduce the amount of 6PPD used in tread or sidewall.
 - i. What worked? What did not work?
 - ii. Is it currently used in production or planned for future production? If planned for future production, what is the timing for that launch?

4) The Safer Consumer Products Regulations require the consortium to consider whether tires can be redesigned to reduce or restrict potential exposures to 6PPD. This may include a change to the configuration or construction of a tire to reduce or eliminate the need for 6PPD.

- a. Please provide any data/information on a construction feature that would eliminate or reduce the amount of 6PPD used in a tire.
 - i. What has worked? What has not worked?
 - ii. Is it currently used in production or planned for future production? If planned for future production, what is the timing for that launch?

5) Other Approaches

- a. Please share any data/information regarding any other approaches beyond those listed above that can be used to reduce/eliminate/reformulate/reconfigure tires to remove/reduce 6PPD. For example - exterior coating or veneer applications, improved tread wear/lower skid, other sidewall solutions that may not work for tread.

6) Use of 6PPD

- a. USTMA has gathered preliminary information regarding the use of 6PPD. Please review the statement below and provide any recommended edits based on the use of 6PPD by your company.
 - i. "Some consortium members began using 6PPD in tire manufacturing in the mid 1960's and early 1970's. However, as tire wear life increased in the 1990s, 6PPD became more widely used by consortium members in the early 2000s."

Appendix E

Derivation of Estimated Tire Shipments into the State of California

Derivation of Estimated Tire Shipments into the State of California

The SCP regulations require companies preparing an AA to include data on the number of product units sold in the State of California. Consortium members do not have data on products sold in California because products are typically sold by third parties. USTMA does collect data on total US shipments of tires by year, but data are not available at the statewide level. This data nonetheless allows us to approximate tire shipments to the State of California, which can be used as a proxy for tire sales. The USTMA shipment data for 2022 are shown below.

Table E.1 USTMA US Tire Shipments for 2022

Vehicle Category	US Tire Shipments in 2022 (Excluding Exports)
Passenger cars/Light Truck	298,847,000
Heavy-duty Truck/Bus	33,139,000
Total	331,986,000

Notes:

US = United States; USTMA = U.S. Tire Manufacturers Association.

Source: U.S. Tire Manufacturers Association (USTMA) Factbook 2024

To determine what percentage of total US tire shipments are attributable to California, 2022 passenger car, bus, and motorcycle vehicle registrations for the US and California were obtained directly from the Federal Highway Administration (FHWA)

Table E.2 FHWA Motor Vehicle Registration Data for 2022

Jurisdiction	Automobiles	Buses	Trucks ¹	Motorcycles	All Vehicles
California	13,796,109	95,965	16,424,539	802,500	31,119,113
US Total	99,946,870	954,119	172,932,334	9,567,664	283,400,986

Notes:

FHWA = Federal Highway Administration; US = Unites States.

(1) Trucks as described by the FHWA includes light duty trucks, heavy duty trucks, vans, and sport vehicle utilities (SUVs).

Source: US Dept. of Transportation (US DOT), Federal Highway Administration (FHWA). 2022. "Highway Statistics 2022."

Accessed on March 6, 2024 at <https://www.fhwa.dot.gov/policyinformation/statistics/2022/>.

The FHWA motor vehicle registration data reports total "trucks" registrations to include heavy duty trucks, light duty trucks, vans, and SUVs; whereas USTMA separates data for heavy duty and light duty trucks. The total number of "trucks" reported in the FHWA data use percentages from a US National Highway Traffic Safety Administration (NHTSA) report, which provided more detailed classifications (*i.e.*, passenger cars, light duty trucks, large trucks, motorcycles, and busses) but only at the national level. The latest publicly available vehicle registration data from NHTSA is from 2021, published in 2023 (NHTSA, 2023). Unfortunately, 2022 data is not yet publicly available.

Table E.3 Latest NHTSA US Motor Vehicle Registration Data (2021)

Vehicle Type	2021 US Motor Vehicle Registrations	Percent of Total
Passenger cars	107,934,093	35.65%
Light duty trucks	170,108,546	56.19%
Large trucks (<i>i.e.</i> , heavy duty trucks)	13,859,181	4.58%
Motorcycles	9,881,414	3.26%
Buses	939,219	0.31%
Calculations:		
Combined light and heavy duty trucks	183,967,727	60.77%
Percent of light duty trucks out of combined truck numbers		92.5%
Percent of heavy duty out of combined truck numbers		7.5%

Notes:

NHTSA = National Highway Traffic Safety Administration; US = United States.

Source: US Dept. of Transportation (US DOT), National Highway Traffic Safety Administration (NHTSA), National Center for Statistics and Analysis (NCSA). December 2023. "Traffic Safety Facts 2021: A Compilation of Motor Vehicle Crash Data." DOT HS 813 527. 225p. Accessed on March 20, 2024 at <https://crashstats.nhtsa.dot.gov/Api/Public/ViewPublication/813527>.

The abovementioned NHTSA data indicates that light duty trucks were 92.5% of the combined truck number and heavy duty trucks were 7.5% of the total truck number. These percentages were applied to the FHWA reported California "truck" registrations to allocate these trucks to the proper category. The passenger car/light duty truck (again, including vans and SUVs) and heavy duty truck/bus combined categories, were then constructed by adding the appropriate numbers. The California percentage of national vehicle registrations in each category was then multiplied against US tire shipments in those categories to arrive at California specific estimates of tires that were shipped and likely to be used in California.

Table E.4 Estimated Annual Shipments of the Priority Product in California

Vehicle Category	Vehicle Registrations in 2022			USTMA Tire Shipments in 2022	
	US	CA	CA% (calc.)	US	CA (est.)
Passenger/Light Duty Truck	259,909,278	28,988,808	11.2%	298,847,000	33,332,000
Heavy Duty Truck/Bus	13,924,044	1,327,805	9.5%	33,139,000	3,160,000
Total	273,833,322	30,316,613	11.1%	331,986,000	36,492,000

Notes:

CA = California; calc. = Calculated; est. = Estimated; US = United States; USTMA = U.S. Tire Manufacturers Association.

As indicated in the table above, an estimated 33,332,000 passenger car/light duty truck tires were shipped to California in 2022 and an estimated 3,160,000 heavy duty truck and bus tires were shipped to California in that year, for an estimated total number of tires shipped to California in 2022 at 36,492,000 units. Data on motorcycle tires are not included in this count because USTMA does not collect data on motorcycle tires. As shown above in the NHTSA data, motorcycle tires represent a very small portion of the overall vehicle fleet and this would not be expected to significantly differ for California.

Appendix F

**List of All Candidate Alternatives Identified and
Reviewed by the Consortium**

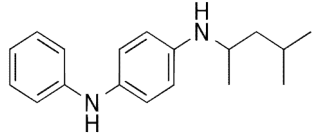
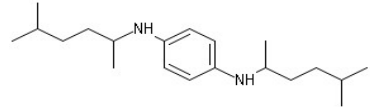
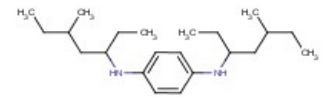
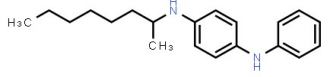
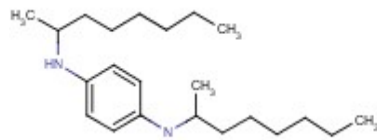
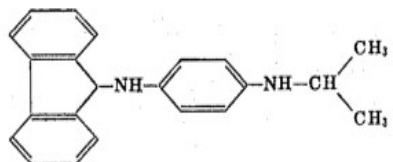
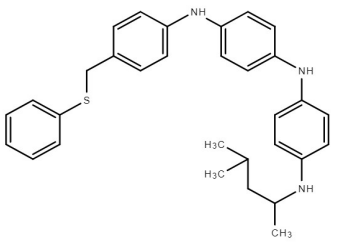
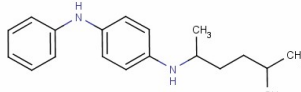
Count	Class of Compounds	Compound	Common Name	Other Names	CAS No.	SMILES	Primary Usage Property - Antidegradant	Compound Effectiveness	Quality of Data	Commercial Availability	Quinone Formation on Oxidation/Ozonation?	Comments	Evaluate Further in Preliminary (Stage 1) AA?	References
1	Phenylene Diamine		6PPD	N1-(4-Methylpentan-2-yl)-N4-phenylbenzene-1,4-diamine N-(1,3-dimethylbutyl)-N'-phenyl-1,4-benzenediamine N-(1,3-dimethylbutyl)-N'-phenyl-p-phenylenediamine DMBPPD	793-24-8	<chem>CC(C)CC(C)NC1=CC=C(C=C1)NC2=CC=CC=C2</chem>	Fatigue Oxygen Ozone	NA	NA	3	Yes	Most effective antiozonant and antioxidant discovered in the past 50 years	Not applicable	1,2,3, 124
2	Phenylene Diamine		77PD	N,N'-Bis(1,4-dimethylpentyl)-phenylenediamine; Tenamene 4; Santoflex 77; Antioxidant 4030; 1-N,4-N-Bis(5-methylhexan-2-yl)benzene-1,4-diamine; UOP 788	3081-14-9	<chem>CC(C)CCC(C)NC1=CC=C(C=C1)NC(C)CCC(C)C</chem>	Fatigue Oxygen Ozone	1	5	2	Yes	Migrates faster than 6PPD, so not as effective in long term protection.	Yes, identified as a possible alternative by DTSC or sources referenced by DTSC, but compound effectiveness score is 1	7, 8, 146
3	Phenylene Diamine		Flexzone 8L UOP 88 DEMPD	N,N'-Bis(1-ethyl-3-methylpentyl)-p-phenylenediamine	139-60-6	<chem>CCC(C)CC(CC)NC1=CC=C(C=C1)NC(C)CC(C)CC</chem>	Fatigue Oxygen Ozone	No data but expected to perform similar to 77PD based on very close structural similarities	N/A	3	Probable	Expected to migrate faster than 6PPD. Reported as a commercial antiozonant in the 1970s.	No, due to compound effectiveness score of 77PD (score of 1)	91, 92, 95
4	Phenylene Diamine		UOP 688; 8PPD	N-1-Methylheptyl-N'-phenyl-p-phenylenediamine	15233-47-3	<chem>CCCCCCC(C)NC1=CC=C(C=C1)NC2=CC=CC=C2</chem>	Fatigue Oxygen Ozone	No data but expected to perform similar to 7PPD based on very close structural similarities	N/A	2	Probable	Same as 77PD but 1 more carbon. Reported as a commercial antiozonant in the 1970s.	Yes, due to compound effectiveness score of 7PPD (score of 4)	90, 92
5	Phenylene Diamine		UOP 288	Di-2-octyl-p-phenylenediamine Elastozone 30	103-96-8	<chem>CCCCCCC(C)NC1=CC=C(C=C1)NC(C)CCCCC</chem>	Fatigue Oxygen Ozone	No data but expected to perform similar to 77PD based on very close structural similarities	N/A	2	Probable	Expected to migrate faster than 6PPD. Reported as a commercial antiozonant in the 1970s.	No, due to compound effectiveness score of 77PD (score of 1)	92,125
6	Phenylene Diamine		N'-Phenyl-N-Fluorenyl-Para-Phenylenediamine	N'-Phenyl-N-Fluorenyl-Para-Phenylenediamine	Not available	<chem>C1=C(NC(C=CC2=CC=CC=C2)C=CC(=C1)NC(C)C(C1=CC2)=CC=2)C(=CC=C2)C1=C2</chem>	Fatigue Oxygen Ozone	4	3	1	Probable	In static ozone tests the compound was equivalent to 77PD	Yes, due to compound effectiveness score of 4	93
7	Phenylene Diamine		N-(p-phenylthiomethylphenyl)-N'-(1,3 dimethyl-butyl)-p-phenylenediamine	N-(p-phenylthiomethylphenyl)-N'-(1,3 dimethyl-butyl)-p-phenylenediamine	Not available	<chem>C1=CC=C(C=C1)SCC1C=CC(=CC=1)NC1=CC=C(C=C1)NC(C)CC(C)C</chem>	Fatigue Oxygen Ozone	4	2	1	Probable	Equivalent to 6PPD in dynamic ozone testing - similar in other tests.	Yes, due to compound effectiveness score of 4	94
8	Phenylene Diamine		7PPD	N-(1,4-Dimethylpentyl)-N'-phenyl-p-phenylenediamine	3081-01-4	<chem>CC(C)CCC(C)NC1=CC=C(C=C1)NC2=CC=CC=C2</chem>	Fatigue Oxygen Ozone	4	Unclear, maybe 5	3	Probable	Similar antiozonant properties to 6PPD; virtually equivalent dynamic ozone in ESRB.	Yes, identified as a possible alternative by DTSC or sources referenced by DTSC. Also compound effectiveness score is 4	9, 122

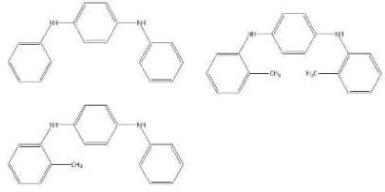
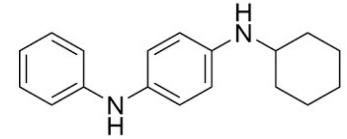
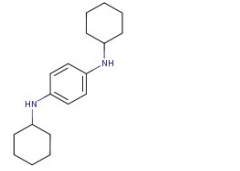
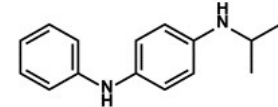
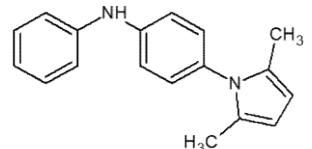
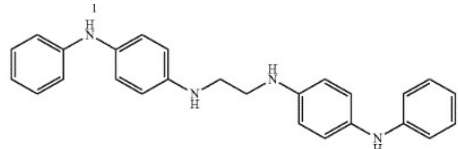
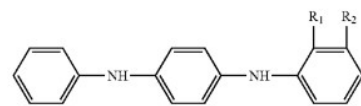
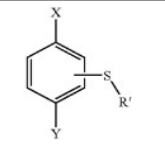

Count	Class of Compounds	Compound	Common Name	Other Names	CAS No.	SMILES	Primary Usage Property - Antidegradant	Compound Effectiveness	Quality of Data	Commercial Availability	Quinone Formation on Oxidation/Ozonation?	Comments	Evaluate Further in Preliminary (Stage 1) AA?	References
9	Phenylene Diamine		DAPD BENPAT Wingstay 100	Wingstay 100; 1,4-Benzenediamine, N,N'-diphenylmethyl derivatives; 1,4-Benzenediamine, N,N'-mixed tolyl and xylyl derivatives; Hydroquinone, o-toluidine, xylylidine condensate	68953-84-4	N/A, Multi-Constituent	Fatigue Oxygen Ozone	4	5	3	Yes	Already used commercially in combination with 6PPD. Could not function on itself because it's slower to migrate than 6PPD. Not as effective an antiozonant as 6PPD.	Yes, due to compound effectiveness score of 4	1, 10, 138, 118, 119
10	Phenylene Diamine		Flexzone 6H Vulkacit 4010 CPPD	N-Cyclohexyl-N'-phenyl-p-phenylenediamine	101-87-1	C1CCC(CC1)NC2=CC=C(C=C2)NC3=CC=CC=C3	Fatigue Oxygen Ozone	3	Unclear, maybe 5	2	Probable	Antioxidant and antiozonant similar to 6PPD.	Yes, identified as a possible alternative by DTSC or sources referenced by DTSC. Also compound effectiveness score is 3	55,56,57,123
11	Phenylene Diamine		UOP 26 CCPD	N,N'-Dicyclohexyl-p-phenylenediamine	4175-38-6	C1CCC(CC1)NC2=CC=C(C=C2)NC3CCCCC3	"Although no specific uses for N,N'-Dicyclohexyl-4-phenylenediamine (CCPD) were identified, based on similarity to other phenylenediamines, it is presumed to be used as an antioxidant / antiozonant, fuel additive, and in monomer distillation" ref. 77 p. i	3	Unclear	2	Probable	Not commonly used as a polymer stabilizer. Expected to have characteristics similar to 77PD.	Yes, identified as a possible alternative by DTSC or sources referenced by DTSC. Also compound effectiveness score is 3	76,77
12	Phenylene Diamine		IPPD	N-Isopropyl-N'-phenyl-1,4-phenylenediamine; Stanguard IPPD	101-72-4	CC(C)NC1=CC=C(C=C1)NC2=CC=CC=C2	Fatigue Oxygen Ozone	4	5	3	Yes	More water soluble than 6PPD; quinone formation probable.	Yes, identified as a possible alternative by DTSC or sources referenced by DTSC. Also compound effectiveness score is 4	1,2
13	Phenylene Diamine		None	4-(2,5-Dimethyl-1H-pyrrol-1-yl)-N-phenylaniline; N-Phenyl-4-(2,5-dimethyl-1H-pyrrole-1-yl)aniline	Not available	C1=CC=C(C=C1)NC1C=CC(=CC=1)N(C1C)C(=CC=1)C	Fatigue (probable, not known) Oxygen (probable, not known) Ozone	4	3	1	Probable, but predicted to be much less than 6PPD	Shown to be an effective antiozonant in rubber. May have less tendency to form quinone because of aromatic pyrrole substructure.	Yes, due to compound effectiveness score of 4	2 (Table 6.2), 14, 15
14	Phenylene Diamine		None	N,N - (Ethane-1,2-diyl) bis (N-phenylbenzene-1 4-diamine; 1-N-[2-(4-anilinoanilino)ethyl]-4-N-phenylbenzene-1,4-diamine	Not available	C1C=CC=C(C=C1)NC(C=CC1NCCNC(C=CC2NC(=CC=C3)C=C3)=CC=2)=CC=1	Fatigue Oxygen Ozone	4	3	1	Probable, but size of quinone molecule may affect toxicity	This and similar materials were shown to be as effective as 6PPD for ozone protection of nitrile rubber. Quinones from this material may be less toxic due to size of molecule.	Yes, due to compound effectiveness score of 4	24,25, 98 (Note the patents contain references to similar materials)
15	Phenylene Diamine		None	4-N-(2,3-Dimethylphenyl)-1-N-phenylbenzene-1,4-diamine- R1 and R2 are methyl	Not available	C1=CC=C(C=C1)NC1=CC=C(C=C1)NC(C1)=C(C(C)=CC=1)C	Fatigue Oxygen Ozone	3	3	1	Probable	No comment	Yes, due to compound effectiveness score of 3	99
16	Phenylene Diamine		None	N,N'-Diphenyl-2-(butylthio)-p-phenylenediamine if R' is n-butyl	Not available	C1C=C(C=CC=1)NC(C=C1)=C(C=C1)NC(C=C1)C(=CC=1)SCCCC	Fatigue Oxygen Ozone	1	3	1	Possible	Data indicates poorer performance for dynamic ozone	No, due to compound effectiveness score of 1	100, 101

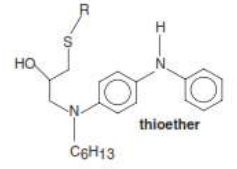
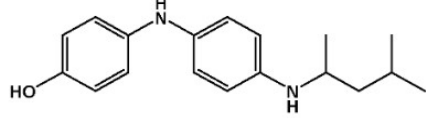
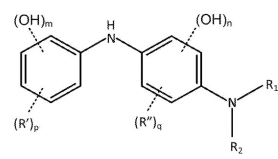
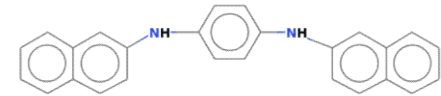
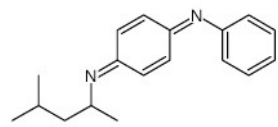
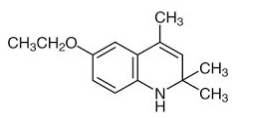
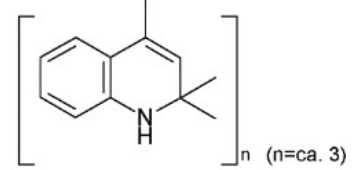
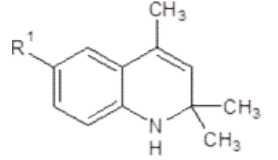
X and Y are NH-Aryl and R' is alkyl or aryl

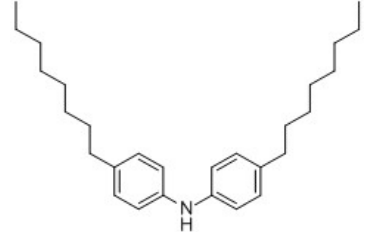
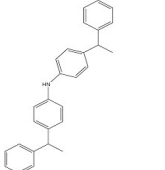
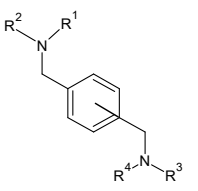
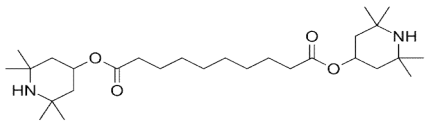
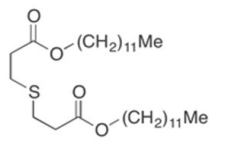
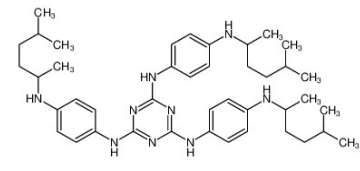
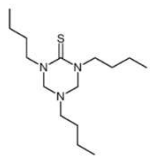
Count	Class of Compounds	Compound	Common Name	Other Names	CAS No.	SMILES	Primary Usage Property - Antidegradant	Compound Effectiveness	Quality of Data	Commercial Availability	Quinone Formation on Oxidation/Ozonation?	Comments	Evaluate Further in Preliminary (Stage 1) AA?	References
17	Phenylene Diamine (Kruger)		RU997 Irgazone 997	Reaction product of N-phenyl-N'-(1,3 dimethylbutyl)-p-phenylenediamine with an alkyl glycidylthioether.	444992-04-5	<chem>C1=CC(=CC=C1)NC1C=CC(=CC=1)N(CC(O)CSC(C)(C)CCCCCCCC)C(CC(C)C)C</chem>	Fatigue Oxygen Ozone	3	1	1	Probable	Non-staining and had been approved for some food use in Europe.	Yes, identified as a possible alternative by DTSC or sources referenced by DTSC. Also compound effectiveness score is 3	46,47,48
18	Phenylene diamine		4-[4-(4-Methylpentan-2-ylamino)anilino]phenol	Not available	Not available	<chem>C1(O)=CC=C(C=C1)N(C1=CC=C(C=C1)NC(C)CC(C)C)</chem>	Oxygen but also claimed as antiozonant	3	3	1	Probable	Prediction of performance based on bond strength; no ozone data.	Yes, due to compound effectiveness score of 3	117, 124
19	Phenylene diamine		This is a class of compounds - Reference uses case where R1 and R2 are methyl; n,p and q are zero and m=1 and is in the para position	Reference example is 4-((4-(dimethylamino)phenyl)amino)phenol	6358-22-1	<chem>CN(C)C1=CC=C(C=C1)NC2=CC=C(C=C2)O</chem>	Fatigue Oxygen Ozone	3-4	4	2	Probable	Recent patent - good static and dynamic ozone resistance in natural rubber black compound.	Yes, identified as a possible alternative by DTSC or sources referenced by DTSC. Also compound effectiveness score is 4	78,79
20	Phenylene diamine		N,N'-Di-2-naphthyl-p-phenylenediamine	DNPD; AgeRite W	93-46-9	<chem>C1=CC=C2C=C(C=CC2=C1)NC3=CC=C(C=C3)NC4=CC5=CC=CC=C5C=C4</chem>	Fatigue Oxygen Ozone	3	1	2	Probable	Listed in a review article as an early commercial antiozonant.	Yes, identified as a possible alternative by DTSC or sources referenced by DTSC. Also compound effectiveness score is 3	86,87
21	Phenylene Diamine related		6QDI	N-4-(1,3-Dimethylbutyl)imino-2,5-cyclohexadien-1-ylidene benzenamine; 4-N-(4-methylpentan-2-yl)-1-N-phenylcyclohexa-2,5-diene-1,4-diimine	52870-46-9	<chem>CC(C)CC(C)N=C1C=C(C=NC2=CC=CC=C2)C=C1</chem>	Fatigue Oxygen Ozone	4	4	2	Yes	Forms 6PPD during use. Partially attaches to polymer on mixing and in service.	Yes, identified as a possible alternative by DTSC or sources referenced by DTSC. Also compound effectiveness score is 4	2,12
22	Dihydroquinoline		Ethoxyquin	Ethoxyquin; 6-Ethoxy-2,2,4-trimethyl-1,2-dihydroquinoline; Santoquin; Antioxidant EC; Santoflex AW	91-53-2	<chem>CCOC1=CC2=C(C=C1)NC(C)=C2C</chem>	Fatigue Oxygen Ozone	1	3	3	Yes	Used as very early antiozonant; heavily staining; used in fish food as an antioxidant but the authorization for that application has been suspended in the EU. Not as effective as 6PPD.	Yes, identified as a possible alternative by DTSC or sources referenced by DTSC, but compound effectiveness score is 1	4,5,6
23	Dihydroquinoline		TMQ	2,2,4-Trimethyl-1H-quinoline	26780-96-1	N/A Polymer	Oxygen Ozone (in combination with 6PPD)	1	Unclear, maybe 5	3	Unlikely	Very low antiozonant activity by itself but acts synergistically with 6PPD.	Yes, identified as a possible alternative by DTSC or sources referenced by DTSC, but compound effectiveness score is 1	1,2
24	Dihydroquinoline		N,N-diethyl-2,2,4-trimethyl-1H-quinolin-6-amine (R=N(C2H5)2)	N,N-Diethyl-2,2,4-trimethyl-1H-quinolin-6-amine (R=N(C2H5)2)	Not available	<chem>C1(C)(C)C=C(C)C(C2N1)C(C)C</chem>	Fatigue (?) Oxygen Ozone	4	2	1	Probable	Amino derivatives of ethoxyquin have been shown to be better antiozonants than ethoxyquin in lab testing.	Yes, due to compound effectiveness score of 4	29, 30, 31 (for morpholine derivative), 32 (comparison of amine derivatives in lab tests)

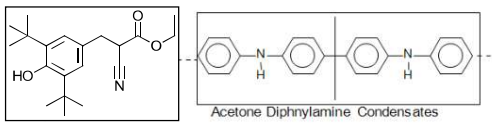
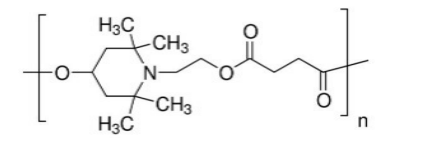
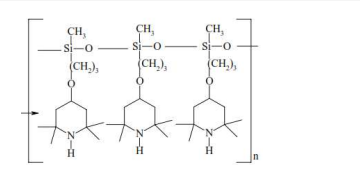
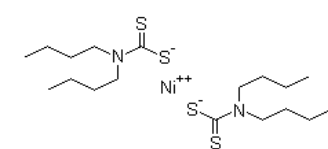
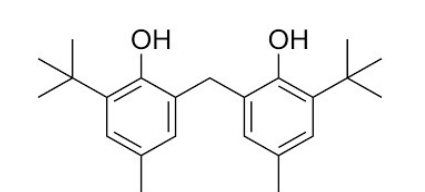
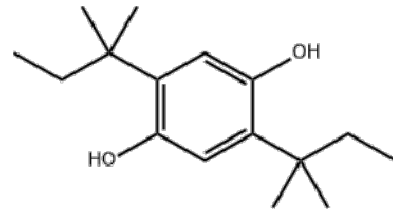
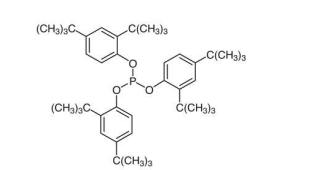
Count	Class of Compounds	Compound	Common Name	Other Names	CAS No.	SMILES	Primary Usage Property - Antidegradant	Compound Effectiveness	Quality of Data	Commercial Availability	Quinone Formation on Oxidation/Ozonation?	Comments	Evaluate Further in Preliminary (Stage 1) AA?	References
25	Diphenyl amine		Dioctyl diphenylamine DOPD	Vanox ODP; Standguard ODP	101-67-7	CCCCCCCCC1=CC=C(C=C1)NC2=CC=C(C=C2)CCCCCCCC	Oxygen	4	1	3	Unlikely	Used in chloroprene rubber for improved flex resistance. 15% better ozone resistance than ethoxyquin and 15% better than DTPD in a Tier 1 type test	Yes, due to compound effectiveness score of 4	31
26	Diphenyl amine		Wingstay 29	4-(1-Phenylethyl)-N-[4-(1-phenylethyl)phenyl]aniline	68442-68-2	CC(C1=CC=CC=C1)C2=CC=C(C=C2)NC3=CC=C(C=C3)C(C)C4=CC=CC=C4	Oxygen	2	1	3	Unlikely	Good antioxidant, but minimal antiozonant activity.	No, due to compound effectiveness score of 2	11, 126
27	Hindered amine		Mixed xylene diamines	N,N'-Dibenzyl-p-xylene-alpha,alpha'-diamine and N,N'-Dibenzyl-m-xylene-alpha,alpha'-diamine perform the best	N,N'-Dibenzyl-p-xylene-alpha,alpha'-diamine- 25790-41-4	N/A Mixture	Fatigue (not known, probably low) Oxygen (not known) Ozone	4	3	2	No, unless R groups are phenyl	Patent claims better crack growth inhibitor than PPDs on exposure to ozone. Quinone formation much less likely than with 6PPD. Best performance was with N,N'-dibenzyl-m,p-xylylenediamine.	Yes, due to compound effectiveness score of 4	16, 17, 18
28	Hindered amine (HALS)		Tinuvin 770	Bis(2,2,6,6-tetramethyl-4-piperidyl) sebacate	52829-07-9	CC1(CC(CC(N1)(C)C)OC(=O)CCCCCCCC(=O)OC2CC(NC(C2)(C)C)C)C)C	Oxygen	2	1	3	No	These are based on 2,2,6,6-tetramethylpiperidine and are used as light stabilizers. They have no ability to protect against ozone.	No, due to compound effectiveness score of 2	48, 49, 81, 127
29	Sulfur compound		DLTPD	Dodecyl 3-(3-dodecoxy-3-oxopropyl)sulfanylpropanoate	123-28-4	O=C(OCCCCCCCCC)CCSCC(=O)OCCCCCCCCC	Oxygen (synergist used with other antioxidants)	2	1	3	No	Does not act as an antiozonant.	Yes, identified as a possible alternative by DTSC or sources referenced by DTSC, but compound effectiveness score is 2	13
30	Triazine		Durazone 37 TAPDT	2,4,6-Tris-(N-1,4-dimethylpentyl-para-phenylenediamino)-1,3,5-triazine; TAPDT	121246-28-4	CC(C)CCC(C)NC1=CC=C(C=C1)NC2=NC(=NC(=N2)NC3=CC=C(C=C3)NC(C)CCC(C)NC4=CC=C(C=C4)NC(C)CC(C)C	Fatigue (unknown) Oxygen (not known, but expected to be good) Ozone	4	Unclear, maybe 5	3	Probable, but size of quinone molecule may affect toxicity	Good solubility in natural rubber but limited solubility in butadiene rubber and SBR. Works as antiozonant at low levels in sidewall with phenolic resin but no comparison to 6PPD. Most likely to migrate too slowly.	Yes, identified as a possible alternative by DTSC or sources referenced by DTSC. Also compound effectiveness score is 4	19, 20
31	Triazinethione		Tetrahydro-1,3,5-tri-n-butyl-(S)-triazinethione	Tetrahydro-1,3,5-tri-n-butyl-(S)-triazinethione	Not available	N1(CCCC)NN(C[C@H](CCCC)C1=S)CCCC	Oxygen Ozone	1	3	1	No	Used as a non-staining antiozonant. Extremely scorchy/cures too fast for rubber to be workable.	No, due to compound effectiveness score of 1. A triazine (e.g., Durazone 37) is evaluated in Preliminary (Stage 1) AA.	27, 28

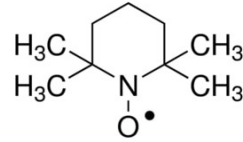
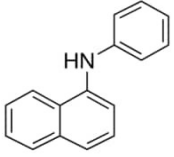
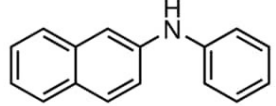
Count	Class of Compounds	Compound	Common Name	Other Names	CAS No.	SMILES	Primary Usage Property - Antidegradant	Compound Effectiveness	Quality of Data	Commercial Availability	Quinone Formation on Oxidation/Ozonation?	Comments	Evaluate Further in Preliminary (Stage 1) AA?	References
32	Polymeric antioxidant		ADPA (not to be confused with p-aminodiphenylamine)	Acetone-Diphenylamine condensate; Accinox BL 755	68412-48-6	<chem>CC(=O)C.C1=CC=C(C=C1)NC2=CC=CC=C2</chem>	Fatigue Oxygen Ozone (poor)	2	1	3	Unknown	Mainly used as an antioxidant in lower cost applications. Poor antiozonant.	No, due to compound effectiveness score of 2	26, 80, 137
33	Polymeric antioxidant		Poly(4-hydroxy-2,2,6,6-tetramethyl-1-piperidineethanol-alt-1,4-butanedioic acid)	2-(4-Methoxy-2,2,6,6-tetramethylpiperidin-1-yl)ethyl 4-oxopentanoate; Photo-stabilizer BW-10LD	65447-77-0	<chem>CC(=O)CCC(=O)OCCN1C(C(C(C)OC)C)C</chem>	Ozone Hindered amine light stabilizer (HALS)	2	1	2	No	Reference reports compound as an antiozonant for polybutadiene but only data shown was on polypropylene. Unlikely to be effective in diene-based polymers.	No, due to compound effectiveness score of 2	38, 128
34	Polymeric siloxane		Uvasil 299	Poly-methylpropyl-3-oxo[4(2,2,6,6-tetramethylpiperidinyl)siloxane]	164648-93-5	N/A Polymer	Oxygen	2	1	1	No	This is a hindered amine light stabilizer and is not expected to have any antiozonant activity.	No, due to compound effectiveness score of 2	50,51
35	Metal dithiocarbamate		Nickel dibutyl dithiocarbamate	Perkacit NDBC; Naugard NBC	13927-77-0	<chem>CCCCN(CCCC)C(=S)[S-].[Ni+2].CCCCN(CCCC)C(=S)[S-].[Ni+2]</chem>	Oxygen Ozone	1	3	3	No	Reasonable antiozone activity but extremely scorchy, making it impractical in tire compounds. Contains high level of nickel.	Yes, identified as a possible alternative by DTSC or sources referenced by DTSC, but compound effectiveness score is 1	26, 52, 53 ,54
36	Hindered phenolic		None	2-Cyano-3-(3,5-ditert-butyl-4-hydroxyphenyl)propionic acid ethyl ester	132631-62-0	<chem>CCOC(=O)C(CC1=CC(=C(C=C1)C(C)(C)O)C(C)(C)C)C#N</chem>	Oxygen Ozone	2	3	1	Probable	Paper claims antiozonant activity similar to IPPD and DPPD but only looks at carbonyl formation during ozonation.	No, due to compound effectiveness score of 2	41, 42
37	Bisphenol		AO2246	2,2'-Methylenebis(6-tert-butyl-4-methylphenol)	119-47-1	<chem>CC1=CC(=C(C=C1)C(C)(C)O)CC2=C(C(=C(C=C2)C(C)(C)O)C(C)(C)O</chem>	Oxygen	2	1	3	Probable	Does not act as antiozonant but is a common antioxidant used as a raw polymer stabilizer; not typically used in final compound.	No, due to compound effectiveness score of 2	43,44, 82, 129
38	Hydroquinone		Santovar A	2,5-Di-tert-amylhydroquinone	79-74-3	<chem>CCC(C)(C)C1=CC(=C(C=C1)C(C)(C)O)C(C)(C)O</chem>	Oxygen	2	1	3	Yes	Does not act as antiozonant but is a common antioxidant used as a raw polymer stabilizer; not typically used in final compound.	No, due to compound effectiveness score of 2	45,82,83,130
39	Phosphite		Irgafos 168	Tris(2,4-ditert-butylphenyl)phosphite	31570-04-4	<chem>CC(C)(C)C1=CC(=C(C=C1)OP(OC2=C(C=C(C=C2)C(C)(C)C)C(C)(C)C)OC3=C(C=C(C=C3)C(C)(C)C)C(C)(C)C)C(C)(C)C</chem>	Fatigue Oxygen	2	1	3	Unlikely	Used as raw polymer stabilizer. Highly hindered phosphites have some antifatigue activity, although most phosphites are decomposed during vulcanization.	No, due to compound effectiveness score of 2	61,62,84 131

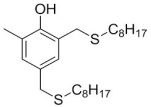
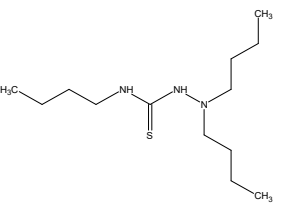
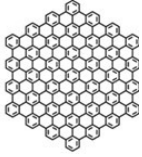
Count	Class of Compounds	Compound	Common Name	Other Names	CAS No.	SMILES	Primary Usage Property - Antidegradant	Compound Effectiveness	Quality of Data	Commercial Availability	Quinone Formation on Oxidation/Ozonation?	Comments	Evaluate Further in Preliminary (Stage 1) AA?	References
40	Nitroxyl compounds		TEMPO	2,2,6,6-Tetramethylpiperidine 1-oxyl,	2564-83-2	CC1(CCCC(N1(O))(C)C)C	UV protection	2	1	2	Not from TEMPO but potentially from other HALS compounds depending on the structure	TEMPO is not used as a polymer stabilizer – it is a precursor to a hindered amine light stabilizer. The nitroxyl species is not an antiozonant.	No, due to compound effectiveness score of 2	67,68, 132
41	Phenyl-naphthyl amines		N-Phenyl-1-naphthylamine	1-Anilinonaphthalene Phenyl-α-naphthylamine	90-30-2	C1=CC=C(C=C1)NC2=CC=CC=CC=C2	Fatigue Oxygen Ozone	3	1	2	Probable	Used in neoprene but not common with diene rubbers used in tires.	Yes, identified as a possible alternative by DTSC or sources referenced by DTSC. Also compound effectiveness score is 3	64, 65
42	Phenyl-naphthyl amines		N-Phenyl-2-naphthylamine	2-Anilinonaphthalene; Phenyl-β-naphthylamine	135-88-6	C1=CC=C(C=C1)NC2=CC=CC=C3C=C2	Fatigue Oxygen Ozone	4	Unclear, maybe 5	2	Possible	An early antiozonant	Yes, identified as a possible alternative by DTSC or sources referenced by DTSC. Also compound effectiveness score is 4	63, 66
43	Ether		Vulcazon AFS	3,9-Dicyclohex-3-enyl-2,4,8,10-tetraoxaspiro[5.5]undecane	6600-31-3	C1CC(CC=C1)C2OCC3(CO2)COC(OC3)C4CC=C4	Ozone (for chloroprene rubber)	2	3	3	No	Shown to be effective in chloroprene and claimed for "natural latex" but unlikely to perform in other diene rubbers. Ineffective with tire elastomers – does not have antiflex properties.	No, due to compound effectiveness score of 2	21,22,23,88
44	Phenol		Irganox 1520 blend	2-Methyl-4,6-bis((octylthio)methyl)phenol (Irganox 1520)	110553-27-0	CCCCCCCCSCC1=CC(=C(C=C1)C)O)CSCCCC	Ozone	4	3	3	Probable Irganox 1520	Shown to be effective in chloroprene and claimed for "natural latex". Shown to be effective in sidewall formulation in combination with Irganox 1520 phenolic antioxidant.	Yes, identified as a possible alternative by DTSC or sources referenced by DTSC. Also compound effectiveness score is 4	21,22,23,85, 88
45	Thiosemicarbazide		1,1,4-Tributyl thiosemicarbazide	1,1,4-Tributyl thiosemicarbazide	Not available	CCCCN(NC(=S)NCCCC)CCCC	Fatigue (unknown) Oxygen (unknown) Ozone	1	2	1	No	Trialkyl thiosemicarbazides have antiozonant properties but are extremely scorchy. Better reaction with ozone than substituted thioureas.	No, due to compound effectiveness score of 1	33
46	Inorganic		Graphene	Prophene™	1034343-98-0	N/A	Fatigue (unknown) Oxygen Ozone	2	3	2	No	Reported to reduce 6PPD when used as a filler in rubber compounds.	Yes, identified as a possible alternative by DTSC or sources referenced by DTSC, but compound effectiveness score is 2	34
47	Inorganic	Al2O3	Alumina (in combination with 6PPD)	Alumina (in combination with 6PPD)	1344-28-1	[O-2].[O-2].[O-2].[Al+3].[Al+3]	Ozone	2	1	3	No	All examples had 6PPD in the formulation. Unlikely to be effective without 6PPD.	No, due to compound effectiveness score of 2	39, 133

Count	Class of Compounds	Compound	Common Name	Other Names	CAS No.	SMILES	Primary Usage Property - Antidegradant	Compound Effectiveness	Quality of Data	Commercial Availability	Quinone Formation on Oxidation/Ozonation?	Comments	Evaluate Further in Preliminary (Stage 1) AA?	References
48	Inorganic	MnO2	Manganese dioxide	Dioxy magnesium	1313-13-9	O=[Mn]=O	None in rubber. Acts to promote oxidation. Ligated manganese salts have been shown to decompose ozone, but no work has been done in rubber.	2	1	3	No	Literature exists on manganese complexes to decompose ozone, but it is known that manganese salts promote oxidation of rubber compounds.	No, due to compound effectiveness score of 2	75,76, 134
49	Hydrazine		1,1' - Pentamethylenebis(2,2-Di-n-Butylhydrazine)	1,1' -Pentamethylenebis(2,2-Di-n-Butylhydrazine)	Not available	CCCCN(CCCC)NCCCC CNN(CCCC)CCCC	Fatigue (unknown) Oxygen (unknown) Ozone	3	3	1	No	Shown to be an antiozonant in dynamic testing of rubber but not compared to conventional antiozonants.	Yes, due to compound effectiveness score of 3	35
50	Imine		N-phenyl-meta-phenoxyphenylmethanimine; 1-(3-phenoxyphenyl)-N-phenylmethanimine	N-Phenyl-meta-phenoxyphenylmethanimine; 1-(3-phenoxyphenyl)-N-phenylmethanimine	Not available	C1(/C=N/C(C=CC)=C C=2)=CC(=CC=C1)OC(C=CC1)=CC=1	Fatigue (unknown) Oxygen (unknown) Ozone	1	1	1	Unlikely	Reported as an antiozonant in rubber.	No, due to compound effectiveness score of 1	36
51	Diamine		1,3-Bis(4-piperidyl)propane; 4-(3-piperidin-4-ylpropyl)piperidine	1,3-Bis(4-piperidyl)propane; 4-(3-piperidin-4-ylpropyl)piperidine	16898-52-5	C1CNCCC1CCCC2CC NCC2	Fatigue (unknown) Oxygen (unknown) Ozone	2	1	2	Depends on structure	Shown to improve crack resistance in static ozone tests on SBR.	No, due to compound effectiveness score of 2	37, 135
52	Nitrone		alpha-C-4-Hydroxy-3,5-dimethylphenyl-N-tert-butyl nitrone	alpha-C-4-Hydroxy-3,5-dimethylphenyl-N-tert-butyl nitrone	Not available	C1(/C=[N+](\ O-))C(C)(C)C=CC(C)=C(C(C)=C1)O	Fatigue Oxygen (unknown) Ozone	4	4	1	Depends on structure, but probable from a phenolic nitrone	Compared to IPPD - reasonable ozone performance, some antifatigue activity, synergistic with phenolic antioxidants. May be able to replace some 6PPD with this material.	Yes, due to compound effectiveness score of 4	40
53	Nitrone + Phenolic AO		alpha-C-4-Hydroxy-3,5-dimethylphenyl-N-isopropyl nitrone and Lowinox WSP	alpha-C-4-Hydroxy-3,5-dimethylphenyl-N-tert-butyl nitrone and Lowinox WSP	Lowinox WSP - 77-62-3; No CAS number for nitrone	N/A Mixture	Fatigue Oxygen Ozone	4	4	Nitrone - 1 Lowinox WSP-3	Probable for both the nitrone and the Lowinox WSP	Blend of two materials gave ozone protection equal to IPPD in static ozone testing. A film was noted on ozone treated rubber.	Yes, due to compound effectiveness score of 4	40, 89
54	Enol ether		Cyclohexen-3-ylidenemethyl benzyl ether Vulkazon® AFD	Benzyl-3-cyclohexen-1-ylidenemethyl ether	22428-48-4	C1CC(=COCC2=CC=C C=C2)CC=C1	Ozone	2	1	1	Unlikely	Claimed to be a good antiozonant for light colored rubber. Not as good as PPD for fatigue. Primarily used with chloroprene.	No, due to compound effectiveness score of 2	69,70,136
55	Phenothiazine		N-(4-methylpentan-2-yl)-10H-phenothiazin-3-amine	3-(1,3-Dimethylbutylamino)phenothiazine	Not available	C1=CC(=CC(=C1NC1=CC2)SC1=CC=2)NC(C)CC(C)C	Ozone	3	1	1	Unlikely	Reported as an antiozonant in rubber but no data in patent.	Yes, due to compound effectiveness score of 3	96,97
56	Unsaturated alcohol		Vitamin A	Retinol	11103-57-4	CC1=C(C(CCC1)(C)C C=CC(=CC=CC(CCO) C)C	Weak food antioxidant; important to biochemical processes	2	1	3	Unlikely	The material would be expected to be decomposed by ozone reacting with the double bonds in the molecule.	No, due to compound effectiveness score of 2	102

Count	Class of Compounds	Compound	Common Name	Other Names	CAS No.	SMILES	Primary Usage Property - Antidegradant	Compound Effectiveness	Quality of Data	Commercial Availability	Quinone Formation on Oxidation/Ozonation?	Comments	Evaluate Further in Preliminary (Stage 1) AA?	References
57	Phenolic		Vitamin E	α-Tocopherols (all isomers)	59-02-9	<chem>CC1=C(C=C(CCC(O)C)CCCC(C)CCCC(C)C(C)C)C(=C1O)C</chem>	Food antioxidant; important in biochemical processes	2	1	3	Probable	As a phenolic, this material would not be expected to act as an effective antiozonant, and there is no data indicating it works in rubber in that capacity. It has been used as an antioxidant in plastics.	No, due to compound effectiveness score of 2	103, 104
58	Conventional lignin		Lignin	Not available	9005-53-2 (other "lignins" may occur as different CAS numbers)	N/A polymer	Mild antioxidant. Has been used in rubber as a filler and a stabilizer. No known antiozonant properties.	2	1	3	Probable, but the quinone would have very high molecular weight	Lignin is complex polymeric phenolic material which also occurs in a sulfonated form with different metal ions which can play a large role in its antioxidant and filler properties. It was compared to octylated diphenyl amine in nitrile rubber. No known antiozonant properties.	No, due to compound effectiveness score of 2	105, 106, 107
59	Alcohol/Acid		Vitamin C	Ascorbic acid	50-81-7	<chem>C(C(C1C(=C(C(=O)O1)O)O)O)O</chem>	Mild antioxidant but important in biochemical processes. Has been used as an antiozonant for plants.	2	1	3	No	Used in plants but not expected to have any antiozonant activity in compounded rubber.	No, due to compound effectiveness score of 2	108, 109
60	Amine		7-(4-Methylpentan-2-ylamino)-2,3,4,10-tetrahydro-1H-acridin-9-one	Not available	Not available	<chem>C1C=C(C=C(C(=N1)C(=O)C(=C1CC1)CC1)N(C)CC(C)C</chem>	Patent claims antiozonant activity but only compared with 6PPD in simple oxidation test - no ozone data.	4	2	1	Unknown	Compound has better oxidation onset temperature than 6PPD, but no ozone data.	Yes, due to compound effectiveness score of 4	110, 115, 116
61	Amine		2-Cyclohexyl-N-(4-methylpentan-2-yl)-1H-indol-5-amine	Not available	Not available	<chem>C1CCC(CC1)C1=CC2=CC(=CC=C2N1)NC(C)C(C)C</chem>	Patent claims antiozonant activity but compared with 6PPD in simple oxidation test and compounding after air aging.	4	2	1	Unknown	Compound has better oxidation onset temperature than 6PPD, but no ozone data.	Yes, due to compound effectiveness score of 4	111, 112
62	Amine		4-(1H-Indol-2-yl)-N-(4-methylpentan-2-yl)aniline	Not available	Not available	<chem>C1C=C2C=C(NC2=CC=1)C1C=CC(=CC=1)N(C)CC(C)C</chem>	Patent claims antiozonant activity but compared with 6PPD in simple oxidation test.	4	2	1	Unknown	Compound has better oxidation onset temperature than 6PPD, but no ozone data.	Yes, due to compound effectiveness score of 4	113, 114
63	Phenylene Diamine		DPPD	1-N,4-N-Diphenylbenzene-1,4-diamine	74-31-7	<chem>C1=CC=C(C=C1)NC2=CC=C(C=C2)NC3=CC=CC=C3</chem>	Fatigue Oxygen Ozone	4	3	3 (as mixture)	Probable	Part of CAS 68478-45-5. Low solubility in rubber; not as good as an antiozonant as 6PPD.	Yes, identified as a possible alternative by DTSC or sources referenced by DTSC. Also compound effectiveness score is 4	75, 76, 118, 1

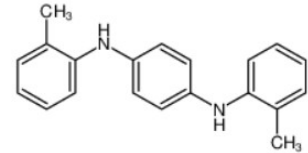
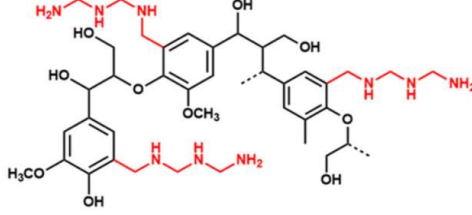
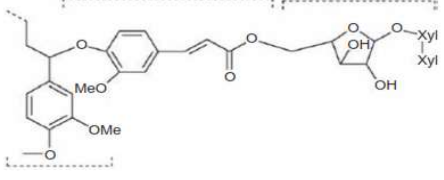
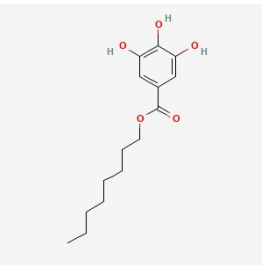
Count	Class of Compounds	Compound	Common Name	Other Names	CAS No.	SMILES	Primary Usage Property - Antidegradant	Compound Effectiveness	Quality of Data	Commercial Availability	Quinone Formation on Oxidation/Ozonation?	Comments	Evaluate Further in Preliminary (Stage 1) AA?	References
64	Phenylene Diamine		DTPD	1-N,4-N-Bis(2-methylphenyl)benzene-1,4-diamine 1,4-Benzenediamine, N,N'-bis(2-methylphenyl)-	68953-84-4	<chem>CC1=CC=C(C=C1)NC2=CC(=CC=C2)NC3=CC=C(C=C3)C</chem>	Fatigue Oxygen Ozone	4	3	3 (as mixture)	Probable	Part of CAS 68478-45-5. Low solubility in rubber; not as good as an antiozonant as 6PPD.	Yes, identified as a possible alternative by DTSC or sources referenced by DTSC. Also compound effectiveness score is 4	119,1
65	Polymeric amine functionalized lignin		Amine functionalized lignin	Not available	Not available	N/A polymer	Antioxidant Antiozonant	4	4	1	Probable, but would be polymer bound	Ozone testing was static, but comparable to 6PPD. Fatigue was similar to 6PPD. Since there is no blooming or reservoir, it is unlikely to provide long term protection.	Yes, identified as a possible alternative by DTSC or sources referenced by DTSC. Also compound effectiveness score is 4	120
66	Phenolic	 + Calcium salt	Calcium salt from lignin rice straw black liquor	Not available	Not available	Not available	Antioxidant	2	1	1	Probable, but would be polymer bound	Reference only claims material as antioxidant; no work with ozone was done.	No, due to compound effectiveness score of 2	121
67	Gallate related	Not available	Rambutan peel extract	Not available	Not available	N/A complex mixture	Antioxidant Antiozonant	4	4	2	Unknown	Static ozone testing showed comparable crack resistance to 6PPD. No dynamic ozone data are available.	Yes, due to compound effectiveness score of 4	139
68	Gallate related		Octyl Gallate	Octyl 3,4,5-trihydroxybenzoate	1034-01-1	<chem>CCCCCCCCOC(=O)C1=CC(=C(C=C1)O)O</chem>	Antioxidant	3	1	3	Unknown	Compound used in food applications. Similar compound, propyl gallate has shown to be active against ozone in protecting biological systems, but no data in tires or tire compounding was found. Octyl gallate was included for evaluation over propyl gallate since octyl gallate has a better melting point for tire compounding.	Yes, similar compound identified as a possible alternative by DTSC or sources referenced by DTSC. Also compound effectiveness score is 3	140

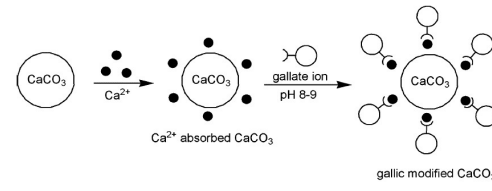
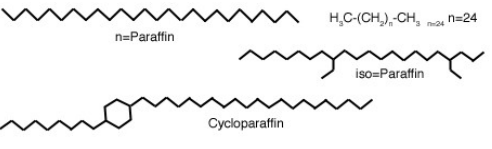
Count	Class of Compounds	Compound	Common Name	Other Names	CAS No.	SMILES	Primary Usage Property - Antidegradant	Compound Effectiveness	Quality of Data	Commercial Availability	Quinone Formation on Oxidation/Ozonation?	Comments	Evaluate Further in Preliminary (Stage 1) AA?	References
69	Gallate related	Not available	Gallate ester of castor oil	Not available	Not available	Not available	Antioxidant	2	1	2	Unknown	Synthesized via esterification between castor oil and gallic acid. Only data as an antioxidant compared to IPPD was available. No ozone data are available.	No, due to compound effectiveness score of 2	143
70	Gallate related		Nano calcium carbonate surface modified by gallic acid	Not available	Not available	Not available	Antioxidant Antiozonant	4	3	2	Unknown	Synthesized by surface coating nano calcium carbonate with gallate ions. Using Irganox 1010 as the control, compound showed improved static ozone resistance. No dynamic ozone data are available.	Yes, due to compound effectiveness score of 4	144
71	Coatings	Mixture	Coating	Mixture	Mixture	Mixture	Ozone (static)	1	3	2	Would depend on coating material, but probably not	In general, coatings wear off during use and would expose the underlying rubber to ozone attack. For examples, tire sidewall coatings will be scuffed when tires brush against curbs. Tire tread coatings will wear off almost immediately. Additionally, performance is also an issue. An example formulated nitrile coated natural rubber compound (Nipol 1312 with several other ingredients) showed significant cracking after ozone exposure.	Yes, identified as a possible alternative by DTSC or sources referenced by DTSC, but compound effectiveness score is 1	141
72	Hydrocarbon wax		microcrystalline wax paraffinic wax	Nochek (blend of waxes for tires)	Not available	CCCCCCCCCCCCCCCC CCCCCCCCCCCC CCCC(C)CCCCCCCC C(CC)CCC.C1(CCCCC CCC)CCC(CC1)CCCC CCCCCCCCCCCC	Ozone (static)	1	5	3	No	In general, waxes bloom to the surface and will wear off during active use. Currently, blends of microcrystalline and paraffin waxes are already used in combination with 6PPD in tires. Waxes alone only provide static ozone protection.	Yes, identified as a possible alternative by DTSC or sources referenced by DTSC, but compound effectiveness score is 1	58,59,60

Count	Class of Compounds	Compound	Common Name	Other Names	CAS No.	SMILES	Primary Usage Property - Antidegradant	Compound Effectiveness	Quality of Data	Commercial Availability	Quinone Formation on Oxidation/Ozonation?	Comments	Evaluate Further in Preliminary (Stage 1) AA?	References
73	Inorganic	Mixture	MOLECULAR REBAR® carbon nanotubes	Not available	Not available	N/A	Anti-static Reinforcing agent	4	3	2-3 (more than lab quantities, but insufficient to even partially replace a significant amount of 6PPD)	No	<p>Preliminary static ozone data is positive. It is not known if carbon nanotube would work by themselves as antiozonants in dynamic ozone tests over prolonged period. May need to be used in conjunction with 6PPD in tires.</p> <p>Additionally, material is highly reinforcing and difficult to mix. Major adjustments required if to be used in tire conventional compounds (e.g., sidewall)</p>	Yes, identified as a possible alternative by DTSC or sources referenced by DTSC. Also compound effectiveness score is 4	142, 145

Notes:

BR = Butadiene Rubber; CAS No. = Chemical Abstracts Service Number; DTSC = Department of Toxic Substances Control; ESBR = Emulsion Styrene Butadiene Rubber; HALS = Hindered Amine Light Stabilizer; N/A = Not Applicable; SBR = Styrene Butadiene Rubber.

Compound Effectiveness Against Ozone	1. Have data and doesn't work
	2. Have no data but chemical molecule will not work
	3. Have no data to say either way
	4. Have some positive data but not enough to say yes or no
Commercial Availability	1. Not available
	2. Laboratory availability only
	3. Multi ton lots
Quality of Data	1. Listed as an antioxidant or antiozonant; little or no data on ozone
	2. Chemical data only (reaction with ozone)
	3. Compounding data (ozone resistance)
	4. Compounding data (ozone/fatigue)
	5. Tire data

Count	Author Names and Publication Date	Reference List
1	Hong <i>et al.</i> , 2016	S. Hong, "Antioxidants and Other Protectant Systems" in Brendan Rodgers' Rubber Compounding Chemistry and Applications, 2nd Ed., CRC Press, 2016 p. 419-459
2	Huntink, 2003	N. Huntink Durability of Rubber Products, PhD Thesis, University of Twente, 2003 (https://ris.utwente.nl/ws/portalfiles/portal/6072556/thesis_Huntink.pdf)
3	Pubchem, 2024	https://pubchem.ncbi.nlm.nih.gov/compound/13101#section=Safety-and-Hazards
4	Stahly, 1968	Comparison of Ethoxyquine with various 6PPD type antiozonants - E.E. Stahly, US Patent 3.391,107, 1968
5	Kristin Hals and Sofia Helena Lindahl, 2020	https://aquafeed.co.uk/entrada/ethoxyquin-ban-in-the-eu-are-there-viable-alternatives-21749
6	Byrne, 2017	Reason for suspending Ethoxyquin authorization in feed - https://www.feednavigator.com/Article/2017/06/12/Ethoxyquin-authorization-suspended-in-the-EU-are-there-viable-alternatives#:~:text=Last%20week%20saw%20the%20European,Official%20Journal%20of%20the%20EU.
7	Pubchem, 2024	https://pubchem.ncbi.nlm.nih.gov/compound/18320
8	ToxServices LLC, 2021	Greenscreen assessment - https://www.ezview.wa.gov/Portals/_1962/Documents/6ppd/GreenScreenExecutiveSummaryFor77PPD.pdf
9	Pubchem, 2024	For a number of patents cited on this material see https://pubchem.ncbi.nlm.nih.gov/compound/92190
10	Lippincott & Peto Inc, 1993	https://www.thefreelibrary.com/Review+of+antiozonants-a014459625
11	Engels <i>et al.</i> , 2011	Engels, Hans-Wilhelm, Herrmann-Josef Weidenhaupt, Manfred Pieroth, Werner Hofmann, Karl-Hans Menting, Thomas Mergenhagen, Ralf Schmoll, and Stefan Uhrlandt. "Rubber, 9. Chemicals and additives." Ullmann's Encyclopedia of industrial chemistry (2000). P.24
12	Huntink, 2004	"Addressing Durability of Rubber Compounds" N. Huntink et al, RC&T (2004) 77 (3): 476-511
13	Pubchem, 2024	https://pubchem.ncbi.nlm.nih.gov/compound/31250
14	KR 20090100673A	KR 20090100673A "Tire Sidewall Composition"
15	Pubchem, 2024	https://pubchem.ncbi.nlm.nih.gov/substance/164110485
16	Masatomo <i>et al.</i> , 1972	E. Masatomo, <i>et al.</i> US 3,634,316 "Sulfur-Vulcanizable Natural, and Synthetic Rubbery Polymers Containing Xylylene Diamines as Antiozonants"
17	Pubchem, 2024	https://pubchem.ncbi.nlm.nih.gov/compound/15320161
18	Pubchem, 2024	https://pubchem.ncbi.nlm.nih.gov/compound/284842
19	Huntink, 2003	N. Huntink Durability of Rubber Products, PhD Thesis, University of Twente, 2003 p. 45 and listed references within (https://ris.utwente.nl/ws/portalfiles/portal/6072556/thesis_Huntink.pdf)
20	Pender, 2008	M. Pender, US 8,329,788 B2, Tire having enhanced ozone resistance
21	Lanxess, 2019	https://lanxess.com/en/Media/Press-Releases/2019/07/Safe-protection-against-oxidation
22	Pubchem, 2024	https://pubchem.ncbi.nlm.nih.gov/compound/98143
23	Bruck <i>et al.</i> , 1985	D. Bruck; H. Konigshofen and L. Ruetz, "The Action of Antiozonants in Rubber " Rubber Chemistry and Technology (1985) 58 (4): 728–739.
24	Pubchem, 2024	https://pubchem.ncbi.nlm.nih.gov/compound/129273577
25	Boone <i>et al.</i> , 2017	M. Boone <i>et al.</i> , US Patent US 10 , 428 , 009 B2 Methods of Making Compounds and Mixtures Having Antidegradant and Antifatigue Efficacy 2019
26	PMC Rubber Chemicals, 2021	https://r.search.yahoo.com/_ylt=AwrNYahZZfNlcwQAY3FXNyOA;_ylu=Y29sbwNiZjEEcG9zAzEEdnRpZAMEc2VjA3Ny/RV=2/RE=1711659609/RO=10/RU=https%3a%2f%2fpmrci.in%2fwp-content%2fuploads%2f2023%2f05%2fPDS_Accinox-BL-75S.pdf/RK=2/RS=eRuCWIHOSDvqjVl6lauca9vBXu0-
27	Rollick <i>et al.</i> , 1991	K. L. Rollick, J. G. Gillick, J. A. Kuczkowski (to The Goodyear Tire & Rubber Co.), May 28, U.S. 5,019,611 (1991)
28	Rollick <i>et al.</i> , 1988	K. L. Rollick, J. G. Gillick, J. L. Bush, and J. A. Kuczkowski, "Triazinethiones: A New Class of Nonstaining Nondiscoloring Antiozonants," paper no. 52 Rubber Division, American Chemical Society, October 18{21, 1988
29	Pubchem, 2024	https://pubchem.ncbi.nlm.nih.gov/compound/85841216

30	Beaver <i>et al.</i> , 1955	D. Beaver, <i>et al.</i> US Patent 2,713,047 6-Diethylamino-1,2-Dihydroquinolines
31	Kilbourne <i>et al.</i> , 1964	H. W. Kilbourne, <i>et al.</i> "Chemical inhibition of ozone degradation of SBR", Rubber Chemistry and Technology, Vol. 32, p. 1155 (1959).
32	Chu <i>et al.</i> , 1966	N. Chu, <i>et al.</i> , "6-Morpholino-2,2,4TR Loweralkyl-1,2 Dihydroquinolines", US Patent 3,275,627
33	Zolotarevskaya, 1973	L. K. Zolotarevskaya, <i>et al.</i> , "1,1,4-Derivatives of Thiosemicarbazide New Non-Staining Antiozonants", Rubber Chemistry and Technology (1973) 46 (2): 517–523 (https://doi.org/10.5254/1.3542922)
34	Paschall <i>et al.</i> , 2022	Doug Paschall <i>et al.</i> , "Tire Compounding with Prophene (sidewall)" Paper presented at Rubber Division Technical Meeting April 2022 (https://rubberworld.com/aircraft-tire-compounding-using-prophene-to-improve-properties/)
35	Stewart, 1964	H. Stewart (1964), US Patent of: "Antiozonant rubber compositions containing alkylene bis-hydrazines" Patent #3,157,616 (https://patentimages.storage.googleapis.com/62/21/2b/5018b550bc1011/US3157616.pdf)
36	Novakov <i>et al.</i> , 1996	I.A. Novakov, Yu.V. Popov, T.K. Korchagina, G.V. Chicherina, O.M. Novopol'tseva (1996) US Patent for: "N-phenyl-meta-phenoxyphenylmethaneimine as an antiager and antiozonant in rubber vulcanization" Patent# RU96112846A (https://patents.google.com/patent/RU2116999C1/en)
37	Murray, 1969	R. Murray (1969), US Patent application 3,436,368 for: "Di-(4-Piperdidyl)-Alkanes as Rubber Antiozonants" (https://patentimages.storage.googleapis.com/96/b6/cd/35a880f69dc8b8/US3436368.pdf)
38	Gugumus, 1999	F. Gugumus, US 5,965,641, Ozone-Resistant Long-Term Stabilisers
39	Kobayashi, 2013	M. Kobayashi (2013), US Patent Application 13198759.6 for: "Antiozonant for Polymers" (https://patentimages.storage.googleapis.com/21/e6/91/4cf8c7fdf6ea3c/EP2746064B1.pdf)
40	Scott and Nethisinghe, 1984	G. Scott, L. Nethisinghe, 1984 UK patent application 2137619A for "Nitron compounds and stabilised rubber compositions containing them" (https://patentimages.storage.googleapis.com/f7/64/a5/0847ccd53a4970/GB2137619A.pdf)
41	Pubchem, 2024	https://pubchem.ncbi.nlm.nih.gov/compound/3549233
42	Ivan <i>et al.</i> , 1992	G. Ivan, M. Giurginca & J.-M. Herdan. "A New Class of Non-Staining Antiozonants for Elastomers, International Journal of Polymeric Materials and Polymeric Biomaterials" (1992) 18 (1-2): 87-93, DOI: 10.1080/00914039208034815
43	Western Reserve Chemical, 2015	https://wrchem.com/product/westco-ao-2246/
44	HB Chemical, 2016	https://www.hbchemical.com/wp-content/uploads/2022/09/AO-2246-SDS.pdf
45	Mayzo, 2024	https://mayzo.com/bnx-tahq.html
46	Kruger <i>et al.</i> , 2005	R. H. Kruger, C. Boissiere, K. Klein-Hartwig & H. -J. Kretschmar (2005) New phenylenediamine antiozonants for commodities based on natural and synthetic rubber, Food Additives and Contaminants, 22:10, 968-974
47	Ciba Specialty Chemicals, 2004	https://www.thefreelibrary.com/Antiozonant%2C+antioxidant+and+antifatigue+agent.-a0131365717
48	Rudolf Pfaendner, 2005	https://www.sciencedirect.com/science/article/abs/pii/S0141391006000413
49	Sigma Aldrich, 2024	https://www.sigmaaldrich.com/US/en/product/aldrich/535834?gclid=Cj0KCQjwmdGYBhDRARIsABmSEePcS_kCID7jMZ0qwOrg64VYg5E2k5KB7cQg26qzR0-jN0vRHxizWIAaAj02EALw_wcB
50	Director Chemicals Notification and Assessment, 1997	https://www.industrialchemicals.gov.au/sites/default/files/NA436%20Public%20Report%20PDF.pdf
51	Huntink, 2003	N. Huntink Durability of Rubber Products, PhD Thesis, University of Twente, 2003 p. 29 (https://ris.utwente.nl/ws/portalfiles/portal/6072556/thesis_Huntink.pdf)
52	Chem Src, 2024	https://www.chemsrc.com/en/baike/311758.html
53	Vanderbilt Chemicals, 2014	https://www.vanderbiltchemicals.com/specs/53815.pdf
54	Chemspider, 2024	https://www.chemspider.com/Chemical-Structure.3718804.html
55	Chemical Book, 2023	https://www.chemicalbook.com/ChemicalProductProperty_EN_CB6255909.htm
56	Pubchem, 2024	https://pubchem.ncbi.nlm.nih.gov/compound/92093
57	Pospíšil, 2005	https://link.springer.com/chapter/10.1007/BFb0025229
58	The International Group, 2024	https://igiwax.com/tire-rubber/
59	HCI, 2024	http://www.hciwax.com/index.php/products/microcrystalline-wax.html

60	Huntink, 2003	N. Huntink Durability of Rubber Products, PhD Thesis, University of Twente, 2003 p. 20 (https://ris.utwente.nl/ws/portalfiles/portal/6072556/thesis_Huntink.pdf)
61	Ismail and Wazzan, 2006	M. N. Ismail & A. A. Wazzan. "Evaluation of New Thermal Stabilizers and Antifatigue Agents for Rubber Vulcanizates" Polymer-Plastics Technology and Engineering (2006) 45 (6):751-758 (https://www.researchgate.net/publication/228671911_Evaluation_of_New_Thermal_Stabilizers_and_Antifatigue_Agents_for_Rubber_Vulcanizates)
62	Huntink, 2003	N. Huntink Durability of Rubber Products, PhD Thesis, University of Twente, 2003 p. 40 (https://ris.utwente.nl/ws/portalfiles/portal/6072556/thesis_Huntink.pdf)
63	Al-Nowaiser, 2006	(F. M. Al-Nowaiser (2006), Evaluation of Some Diphenylamine Derivatives as Thermal Stabilizers and Antifatigue Agents in Natural Rubber Vulcanizates, International Journal of Polymeric Materials and Polymeric Biomaterials, 54:10, 963-973 (https://doi.org/10.1080/009140390504799)
64	Pubchem, 2024	https://pubchem.ncbi.nlm.nih.gov/compound/N-Phenyl-1-naphthylamine
65	Murray, 1959	R. M. Murray, (1959) Factors Influencing the Ozone Resistance of Neoprene Vulcanizates under Flexure, Rubber Chem. And Technol. 32:4, 1117-1133 (https://doi.org/10.5254/1.3542471)
66	Ambelang <i>et al.</i> , 1963	J. C. Ambelang; R. H. Kline; O. M. Lorenz; C. R. Parks; Coe Wadelin; J. Reid Shelton (1963) "Antioxidants and antiozonants for general purpose elastomers." Rubber Chemistry and Technology 36.5: 1497-1541. (https://doi.org/10.5254/1.3539652)
67	Klemchuk and Gande, 1989	P.P Klemchuk and M. E. Gande (1989) Stabalization mechanisms of hindered amines, Macromolecular Symposia 28:1, 117-144 (https://onlinelibrary.wiley.com/doi/abs/10.1002/masy.19890280110)
68	Brede and Göttinger, 1999	O. Brede, H. A. Göttinger (1999), Transformation of sterically hindered amines (HALS) to nitroxyl radicals: What are the actual stabilizers, Macro Molecular Materials and Engineering 261-262:1, 45-54 (https://onlinelibrary.wiley.com/doi/abs/10.1002/(SICI)1522-9505(19981201)261-262:1%3C45::AID-APMC45%3E3.0.CO;2-W)
69	Huntink, 2003	N. Huntink Durability of Rubber Products, PhD Thesis, University of Twente, 2003 p. 43 (https://ris.utwente.nl/ws/portalfiles/portal/6072556/thesis_Huntink.pdf)
70	Lanxess, 2006	https://chemical.sorengrupp.com/static/datasheets/accleratore/accleratore.pdf
71	Pubchem, 2024	https://pubchem.ncbi.nlm.nih.gov/compound/7569#section=Computed-Properties
72	Chemical Book, 2023	https://www.chemicalbook.com/ProductList_En.aspx?kwd=101-67-7
73	Harwick Standard Distribution Corporation	http://harwick.com/files/tds/HARWICK_ANTIDEGRADENTS.PDF
74	Pubchem, 2024	https://pubchem.ncbi.nlm.nih.gov/compound/7589
74a	Stahly, 1956	E. Stahly, US 3,157,615 Antiozonants and antiozonant compositions for elastomers
75	Rodgers and Waddel, 2013	https://www.sciencedirect.com/science/article/pii/B9780123945846000091
76	Pubchem, 2024	https://pubchem.ncbi.nlm.nih.gov/compound/77836
77	ToxServices LLC, 2021	https://www.ezview.wa.gov/Portals/_1962/Documents/6ppd/GreenScreenExecutiveSummaryForCCPD.pdf
78	Yang and Arnold, 2020	X. Yang and J. Arnold, World Patent WO 2022/146441 A1 "Rubber Composition with Longer Lasting Antiozonation"
79	Pubchem, 2024	https://pubchem.ncbi.nlm.nih.gov/compound/80677
80	Kilbourne <i>et al.</i> , 1959	Kilbourne, H.W. <i>et al.</i> RCT, 1959, 32, 1155-1163
81	Gijnsman, 2010	Pieter Gijnsman (2010). "Photostabilisation of Polymer Materials". In Norman S. Allen (ed.). Photochemistry and Photophysics of Polymer Materials Photochemistry. Hoboken: John Wiley & Sons. pp. 627–679
82	Ambelang <i>et al.</i> , 1963	J. C. Ambelang; R. H. Kline; O. M. Lorenz; C. R. Parks; Coe Wadelin; J. Reid Shelton (1963) "Antioxidants and antiozonants for general purpose elastomers." Rubber Chemistry and Technology 36.5: 1497-1541. (https://doi.org/10.5254/1.3539652)
83	Zhu <i>et al.</i> , 1997	Q. Zhu, X.-M. Zhang, and A. J. Fry (1997) Bond dissociation energies of antioxidants, Polym. Degrad. Stab. 57:1 (https://www.sciencedirect.com/science/article/abs/pii/S0141391096002248?via%3Dihub)
84	BASF, 2021	https://r.search.yahoo.com/_ylt=AwrEs2mZZPNlqQA2LNxNyoA;_ylu=Y29sbwNiZjEEcG9zAzEEdnRpZAMEc2VjA3Ny/RV=2/RE=1711659418/RO=10/RU=https%3a%2f%2fplastics-rubber.basf.com%2fsd-plastic-additives%2fproducts%2ffiles%2fTI_Irgafos_168_EVK_%25201018_e_V10-2021%2520-%2520.pdf/RK=2/RS=ZEvu68Dpg2FFnm4k6Bpy12wBBWs-

85	Dall'abaco <i>et al.</i> , 2018	D Dall'abaco, V. Formaggio, <i>et al.</i> , (2018) US Patent for: "Tyre for Vehicle Wheels". Patent# 11518192 https://patents.justia.com/patent/11518192
86	Pubchem, 2024	https://pubchem.ncbi.nlm.nih.gov/compound/7142
87	Lattimer and Layer, 1990	R. Layer and R. Lattimer, " Protection of rubber against ozone, RCT", RCT, Vol. 63, 426 (1990)
88	Lanxess, 2010	https://lanxess.co.uk/uploads/tx_lanxessmatrix/2010_produktbroschuere_2010-01.pdf
89	Nethisinghe and Scott, 1984	L. Nethisinghe and G. Scott, "Mechanism of antioxidant action: The Antioxidant activity of "Spin-traps" in rubber, Rubber Chemistry and Technology (1984) 57 (4): 779–791. (https://doi.org/10.5254/1.3536033)
90	Pubchem, 2024	https://pubchem.ncbi.nlm.nih.gov/compound/85821#section=Depositor-Supplied-Synonyms
91	Pubchem, 2024	https://pubchem.ncbi.nlm.nih.gov/compound/94138
92	Jacob, 2021	A. Jacob, US Patent Application 20230312874 for: "Compound, rubber mixture containing the compound, vehicle tire which has at least one component comprising the rubber mixture, method for producing the compound, and use of the compound as an aging protection agent and/or antioxidant agent and/or antiozonant and/or dye". (https://patentimages.storage.googleapis.com/01/f9/fd/5e07d00c107f02/US20230312874A1.pdf)
93	Hunt, 1974	J. Hunt, US 3,625,913, "N'-Alkyl, and N'-Aryl-N-Fluorenyl-P-Phenylene-Diamines as Antiozonants in Natural and Synthetic Diene Rubbers"
94	Kuczkowski, 1978	J. Kuczkowski, US 4,124,565, "N,N' -Disubstituted-P-Phenylenediamines"
95	Look Chem, 2024	https://www.lookchem.com/casno139-60-6.html
96	Pubchem, 2024	https://pubchem.ncbi.nlm.nih.gov/compound/163231042#section=Computed-Properties
97	Recker <i>et al.</i> , 2022	C. Recker <i>et al.</i> , 2022 Patent WO2022069001A1 "Phenothiazine compound, its preparation and use in rubber blends and vehicle tires, as ageing protectant, antioxidant, antiozonant and colorant"
98	Boone <i>et al.</i> , 2020	Boone, <i>et al.</i> . EP 3 394 028 B1, Compounds with Antidegradant and Antifatigue Efficacy and Compositions Including Said Compounds, 2020
99	Gao and Li, 2019	Y. Gao and H. Li, 2019, European Patent Application EP3983375A1 "Low-pollution antidegradant compound and antidegradant composition and rubber composition comprising the same for tires" (https://patents.google.com/patent/EP3983375A1/en)
100	Maender <i>et al.</i> , 2003	O Maender, <i>et al.</i> . US Patent 7,718,722 "Alkylthio- and Aryl(Heteroyl)Thio-Substituted P-Phenylenediamines, their Manufacture and their use in Rubber"
101	Pubchem, 2024	https://pubchem.ncbi.nlm.nih.gov/compound/16085088
102	Pubchem, 2024	https://pubchem.ncbi.nlm.nih.gov/compound/445354
103	Suffield <i>et al.</i> , 2004	R Suffield <i>et al.</i> , "Evaluation of antioxidant performance of a natural product in polyolefins" Journal of Vinyl and Additive Technology March 2004 10(1):52-56 (DOI:10.1002/vnl.20007)
104	Pubchem, 2024	https://pubchem.ncbi.nlm.nih.gov/compound/14985
105	Mohamad Aini <i>et al.</i> , 2020	Nor Anizah Mohamad Aini <i>et al.</i> , "Lignin as Alternative Reinforcing Filler in the Rubber Industry: A Review", Frontiers in Materials January 2020, Volume 6, Article 329
106	Pubchem, 2024	https://www.ncbi.nlm.nih.gov/pcsubstance/?term=%22Lignin%22[CompleteSynonym] and references therein
107	Jagadale <i>et al.</i> , 2017	S. Jagadale <i>et al.</i> , "Evaluation of Lignin as Green Alternative to Synthetic Antidegradants in Nitrile Rubber", International Journal of Research in Engineering and Applied Sciences, Vol. 7 Issue 3, March-2017, pp. 51~62
108	Mudd, 1998	J.B. Mudd, "Biochemical Reactions of Ozone in Plants", USDA Forest Service Gen.Tech.Rep. PSW-GTR-166. 1998
109	Pubchem, 2024	https://pubchem.ncbi.nlm.nih.gov/compound/54670067
110	Jacob <i>et al.</i> , 2023	A. Jacob <i>et al.</i> , "Compound, rubber blend containing the compound, vehicle tire comprising the rubber blend in at least one component, process for producing the compound, and use of the compound as an ageing protectant and/or antiozonant and/or dye", WO 2023001338 A1
111	Pubchem, 2024	https://pubchem.ncbi.nlm.nih.gov/compound/166484666
112	Jacob <i>et al.</i> , 2023	A. Jacob <i>et al.</i> , "Compound, rubber blend containing the compound, vehicle tire comprising the rubber blend in at least one component, process for producing the compound, and use of the compound as an ageing protectant and/or antiozonant and/or dye", WO 2023001339 A1

113	Pubchem, 2024	https://pubchem.ncbi.nlm.nih.gov/compound/166484669
114	Jacob <i>et al.</i> , 2023	A. Jacob <i>et al.</i> , "Compound, rubber mixture containing the compound, vehicle tire which has at least one component comprising the rubber mixture, process for preparing the compound, and use of the compound as an aging protection agent and/or antiozonant and/or colorant", WO2023001340A1
115	Jacob <i>et al.</i> , 2023	A. Jacob <i>et al.</i> , "Compound, rubber blend containing the compound, vehicle tire comprising the rubber blend in at least one component, process for producing the compound, and use of the compound as an ageing protectant and/or antiozonant and/or dye", EP4190856A1
116	Jacob <i>et al.</i> , 2023	A. Jacob <i>et al.</i> , "Compound, rubber blend containing the compound, vehicle tire comprising the rubber blend in at least one component, process for producing the compound, and use of the compound as an ageing protectant and/or antiozonant and/or dye", WO 2023098954 A1
117	Pubchem, 2024	https://pubchem.ncbi.nlm.nih.gov/compound/118270248
118	Pubchem, 2024	https://pubchem.ncbi.nlm.nih.gov/compound/6319
119	Pubchem, 2024	https://pubchem.ncbi.nlm.nih.gov/compound/84756
120	Chung <i>et al.</i> , 2023	J. Chung, U. Hwang, J. Kim, N. Kim, J. Nam, J. Jung, S. Kim, J. Cho, B. Lee, I. Park, J. Suhr, D. Nam, "Amine-functionalized lignin as an eco-friendly antioxidant for rubber compounds" ACS Sustainable Chemistry and Engineering 2023, 11 (6), 2303-2313
121	Zaher <i>et al.</i> , 2014	K. Zaher, R. Swellem, G. Nawwar, F. Abdelrazek, S. El-Sabbagh, Proper use of rice straw black liquor: lignin/silica derivatives as efficient green antioxidants for SBR rubber, Pigment and Resin technology, April 2014, p. 159
122	Wilder, 1974	G. Wilder, US 3,839,275 "Preserving rubber with N-(1,4 dimethylamyl) -N'-para-phenylenediamine"
123	Kosmin <i>et al.</i> , 1970	US 3,511,805, M. Kosmin <i>et al.</i> , "Rubber preserved with alicyclicmethyl phenylenediamines"
124	Jacob, 2021	A. Jacob, US Patent Application 20230312874 for: "Compound, rubber mixture containing the compound, vehicle tire which has at least one component comprising the rubber mixture, method for producing the compound, and use of the compound as an aging protection agent and/or antioxidant agent and/or antiozonant and/or dye". (https://patentimages.storage.googleapis.com/01/f9/fd/5e07d00c107f02/US20230312874A1.pdf)
125	Pubchem, 2024	https://pubchem.ncbi.nlm.nih.gov/compound/7688
126	Pubchem, 2024	https://pubchem.ncbi.nlm.nih.gov/compound/108418
127	Pubchem, 2024	https://pubchem.ncbi.nlm.nih.gov/compound/164282
128	Pubchem, 2024	https://pubchem.ncbi.nlm.nih.gov/compound/22946613
129	Pubchem, 2024	https://pubchem.ncbi.nlm.nih.gov/compound/8398
130	Pubchem, 2024	https://pubchem.ncbi.nlm.nih.gov/compound/6610
131	Pubchem, 2024	https://pubchem.ncbi.nlm.nih.gov/compound/91601
132	Pubchem, 2024	https://pubchem.ncbi.nlm.nih.gov/compound/2724126
133	Pubchem, 2024	https://pubchem.ncbi.nlm.nih.gov/compound/9989226
134	Pubchem, 2024	https://pubchem.ncbi.nlm.nih.gov/compound/14801
135	Pubchem, 2024	142
136	Pubchem, 2024	https://pubchem.ncbi.nlm.nih.gov/compound/90782
137	Pubchem, 2024	https://pubchem.ncbi.nlm.nih.gov/compound/165719
138	European Chemicals Agency (ECHA), 2024	https://echa.europa.eu/registration-dossier/-/registered-dossier/13540
139	Sukatta, 2021	Sukatta U, Rugthaworn P, Seangyen W, Tantaterdtam R, Smitthipong W, Chollakup R. Prospects for rambutan peel extract as natural antioxidant on the aging properties of vulcanized natural rubber. SPE Polymers. 2021;2:199-209. https://doi.org/10.1002/pls2.10042
140	Pauls and Thompson, 1982	Pauls, K.P. and Thompson, J.E. (1982) Effects of Cytokinins and Antioxidants on the Susceptibility of Membranes to Ozone Damage. Plant and Cell Physiology, 23, 821-832.
141	M. Bhala, 1997	M. Bhala, "Non-migratory antiozonant system for natural rubber", Ph.D Thesis, Loughborough University https://repository.lboro.ac.uk/ndownloader/files/16810526/1

142	X. Guo, 2023	X. Guo, Improving Dispersion of Carbon Nanotubes in Natural Rubber by Using Waterjet-Produced Rubber Powder as a Carrier, <i>Polymers</i> 2023, 15, 477
143	Kandil <i>et al.</i> , 2021	Kandil H, Moshera S, El-Nashar DE. Gallate ester of castor oil as a multifunctional in HAF carbon black-filled natural rubber composites additive. <i>J Vinyl Addit Technol</i> 2022; 28: 331–342.
144	Poompradub <i>et al.</i> , 2011	Poompradub, Sirilux et al. "Improving oxidation stability and mechanical properties of natural rubber vulcanizates filled with calcium carbonate modified by gallic acid." <i>Polymer Bulletin</i> 66 (2011): 965-977.
145	Unpublished summary from Molecular Rebar Design sent to USTMA on June 17, 2024	Molecular Rebar Design, May 22, 2024. "Successful results: Molecular Rebar Rubber Compounds Eliminating Need for 6PPD"
146	Flexsys, 2023	Antiozonant study conducted at Flexsys in 2023